



# CATALOGUE & PRICELIST 2022

Solutions in the field of WATER SUPPLY,  
AGRICULTURE, GARDEN & TURF IRRIGATION, and  
TELECOMMUNICATION





## WHO WE ARE?

Poliext is a family-owned PRODUCTION COMPANY located in HUNGARY, offering a suitable solution in the field of CONSTRUCTION, WATER SUPPLY & IRRIGATION. Poliext was ESTABLISHED IN 1991 and has more than 30 YEARS HISTORY. During these years our company has been recognized for quality products.



## HISTORY

Our history begins in 1919, with the foundation of the Skala family's first private business. The founder of the company was MR. MIHALJ SKALA.

In the year 1991, MR. ZOLTAN SKALA established the company Poliext Csövek Kft. in Hungary. The production started on a 1300 m<sup>2</sup> area, with three extruder machines and eight employees.



## QUALITY

Our quality management system is certified by ISO 9001, and our products by several European certifications (DVGW, KIWA, ÉMI, ITC, ACS, etc.)



## SALES NETWORK

We provide high-quality water-saving solutions worldwide. Today Poliext exports to 30 COUNTRIES, on 4 CONTINENTS with more than 1000 REGULAR CUSTOMERS.



## OUR PRODUCTS

Besides PE PIPES, our specialty, PP COMPRESSION FITTINGS PN16 are our most important and well-known products. High-quality, massive fitting with NO quality claim. The wide product range has been fulfilled with COMPRESSION BALL VALVES and PP COMPRESSION FITTINGS PN10 line. Besides this, IRRIGATION SECTOR is an equally important part of our production. We produce DRIP-LINE under the brand POLIDRIP, as well as FITTINGS AND VALVES FOR DRIP-LINE.



## IRRIGATION SOLUTIONS

Comprehensive solutions for irrigation systems (DESIGN, SUPPLY OF THE EQUIPMENT, IMPLEMENTATION, COMMISSIONING, OPERATION & MANAGEMENT, and TRAINING). Experts from the Poliext team bring the know-how and modern technologies in irrigation systems for orchards, field crops, and protected crops. Our goal is to optimize water, fertilizer, and energy and achieve HIGHER YIELDS and BETTER-QUALITY CROPS. We provide technological solutions to address real agricultural challenges.

# CONTENTS

## FEATURED PRODUCTS 4 - 5

## IRRIGATION SOLUTIONS 6

## PIPES 9 - 17

<b>Drinking water pipes</b>	<b>10 - 11</b>
Drinking water pipes PE100	11
<b>Irrigation pipes</b>	<b>12 - 17</b>
Agricultural pipes	13 - 14
Irrigation LDPE pipes	15
White LDPE Pipes	16
Other irrigation pipes	17
Layflat hoses	17
PVC Microtube	17
Flex pipe for Pop-up	17

## HIGH-PRESSURE FITTINGS 19 - 41

<b>PP Compression fittings PN16</b>	<b>20 - 25</b>
<b>PP Compression fittings PN10</b>	<b>26 - 31</b>
<b>PP Clamp saddles</b>	<b>32 - 34</b>
<b>Threaded fittings</b>	<b>35 - 38</b>
Manifold fittings	39
<b>Layflat fittings</b>	<b>40</b>
<b>Aluminium fittings</b>	<b>41</b>

## DRIPLINE FITTINGS 43 - 57

<b>Drip pipe fittings</b>	<b>44 - 51</b>
Lock type fittings	45 - 46
Quick joints	47 - 48
Barbed fittings	49 - 51
<b>Drip tape fittings</b>	<b>52 - 57</b>
Tape fittings	53 - 54
Tape fittings with ring	55 - 56
Conic tape fittings	57

## VALVES 59 - 73

<b>Low-pressure valves</b>	<b>60 - 66</b>
Cylinder MINI valves	61 - 63
Cylinder valves	64 - 66
<b>High-pressure valves</b>	<b>67 - 70</b>
PP Compression valves	68
PP Stop valves	68
Ball valves	69
Garden valve PN16	69
Pressure regulators	70
Check valve	70
<b>Other valves</b>	<b>71 - 73</b>
Quick coupling valve	71
Air releasing valve	71
Drain valve	71
Plastic vacuum breaker	72
Fertilizing equipment	72
Metallic valves	72
Bermad electric control valves	73

## FILTERS 75 - 79

<b>Plastic filters</b>	<b>76 - 77</b>
Screen filters	76
Disc filters	77
Hydrocyclones	77
<b>Metal filters</b>	<b>78 - 79</b>
AutoFlush® automatic disc filter	78
Automatic double gravel filter	78
Metal scree/disc filter Y	79
Hydrocyclones	79

## MICRO IRRIGATION 81 - 102

<b>PoliDrip driplines</b>	<b>82 - 84</b>
PoliDrip Non-PC	83 - 84
PoliDrip Garden Non-PC	84
PoliDrip PC	85 - 86
PoliDrip PCND	87
PoliDrip Garden PC	87
<b>PoliDrip Light driplines</b>	<b>88 - 91</b>
PoliDrip Non-PC Light	88 - 89
PoliDrip PC Light	90 - 91
<b>Assif AS-PC driplines</b>	<b>92</b>
<b>Drip tapes</b>	<b>93 - 97</b>
PoliTape	94 - 95
PoliFlat	96 - 97
<b>Drip irrigation accessories</b>	<b>98</b>
On-Line Non-PC Drippers	98
On-Line PC Drippers	98
On-Line PCND Drippers	98
Accessories	98
<b>Sprinkler irrigation</b>	<b>99 - 102</b>
Impulse sprinklers	100
Micro irrigation accessories	101
Microsprinklers	102

## GARDEN & LANDSCAPE 103 - 113

<b>Valve boxes</b>	<b>104 - 106</b>
<b>Plastic grass grid</b>	<b>107 - 109</b>
Grass Saver Raster	108
Eco Grass Grid	109
<b>Living green wall</b>	<b>110 - 111</b>
<b>Heliflex home garden</b>	<b>112 - 113</b>

## OTHER 115 - 118

<b>Equipment</b>	116
<b>Tools &amp; Accessories</b>	117
<b>Polyduct shafts and tanks</b>	118

## DIY 119 - 121

<b>PE Pipes small coils</b>	<b>119</b>
<b>PoliTape small package</b>	<b>119</b>
<b>DIY Professional irrigation kits</b>	<b>120 - 121</b>
Garden drip irrigation	120
Vegetable drip irrigation	120
Living Green Wall DIY set	121

**NEW**

## LIVING GREEN WALL



UV STABLE

CHEMICAL AND HEAT RESISTANT

BUILT-IN RESERVOIR SYSTEM

BLOCKAGE FREE DRAINAGE

MODULAR AND EXPANDABLE

EASY INSTALLATION



Find out more on page 110



Find out more on page 121

**NEW**

## CYLINDER VALVES

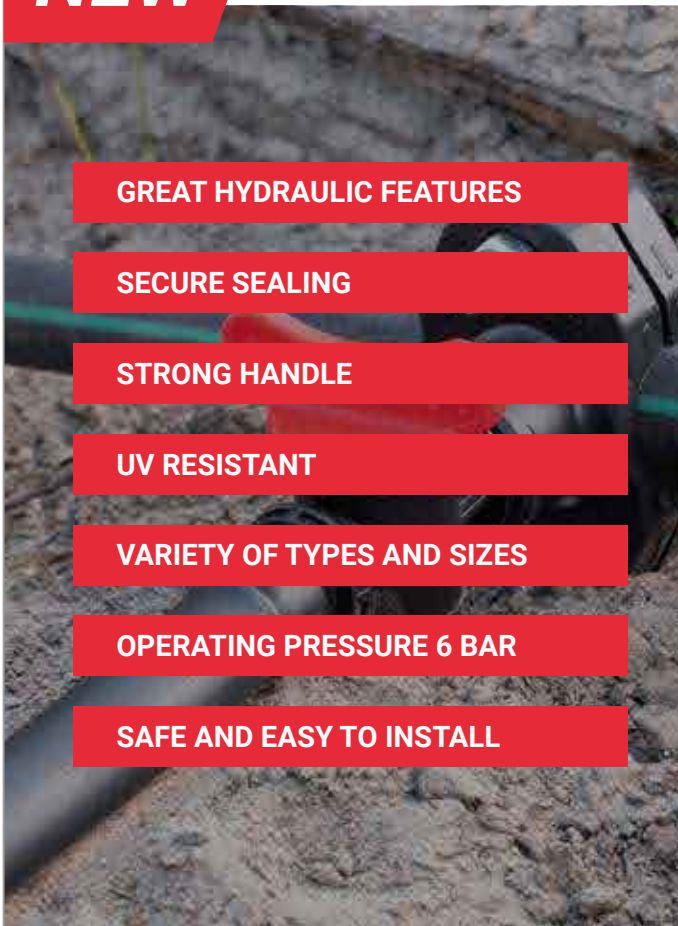

GREAT HYDRAULIC FEATURES

SECURE SEALING

STRONG HANDLE

UV RESISTANT

VARIETY OF TYPES AND SIZES

OPERATING PRESSURE 6 BAR

SAFE AND EASY TO INSTALL



Find out more on page 64

# FEATURED

## DRIP IRRIGATION DIY KITS

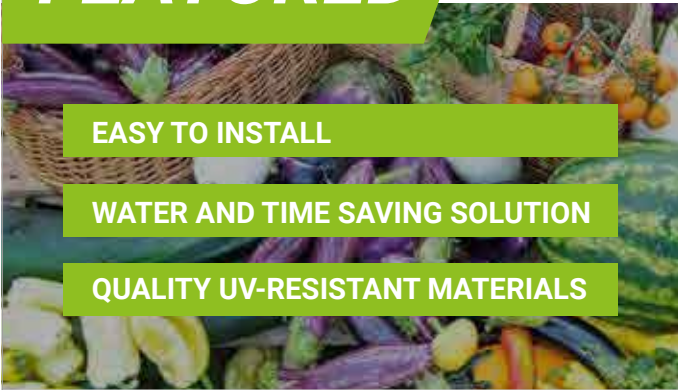

EASY TO INSTALL

WATER AND TIME SAVING SOLUTION

QUALITY UV-RESISTANT MATERIALS



Find out more on page 120

# SOON

## ECO GRASS GRID

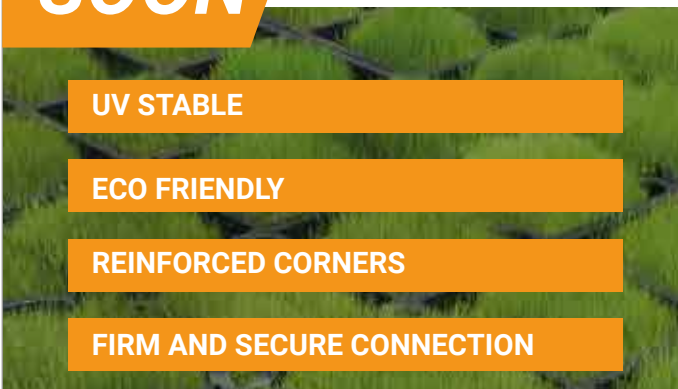

UV STABLE

ECO FRIENDLY

REINFORCED CORNERS

FIRM AND SECURE CONNECTION



Find out more on page 109

# NEW

## WHITE LDPE PIPE



FOR GREENHOUSE APPLICATION

OPERATING PRESSURE 6 BAR

PREVENTS ALGAE GROWTH

UV RESISTANT



Find out more on page 16

# NEW

## METAL VALVE



HIGHLY EFFICIENT FILTRATION

LONG ECONOMIC LIFE

EASE OF USE AND MAINTENANCE



Find out more on page 78



# Complete Irrigation Solutions

*Made to fit your needs*

Experts from the Polixt team are bringing the know-how and modern technologies in irrigation systems for orchards, field crops, and protected crops.

Design

Supply of equipment

Implementation

Commissioning

Operation & Management

Training

Turn-Key solutions

We are creating a hydraulic map and irrigation system solution based on relevant information:

- Water source characteristics
- Water and soil analysis
- Climatic characteristics
- Google earth map
- Topographic maps
- Planting plan
- Client requirements

Our goal is to optimize water, fertilizer, energy and achieve a better yield.



## SDI Sub-surface Drip Irrigation

Fertigation

Filtration

REMOTE CONTROL  
Automation

Technical Support



## Frost Protection

Sprinklers

Valves

Drip lines

Drip line fittings



## Drip Irrigation

High pressure fittings

Pipes

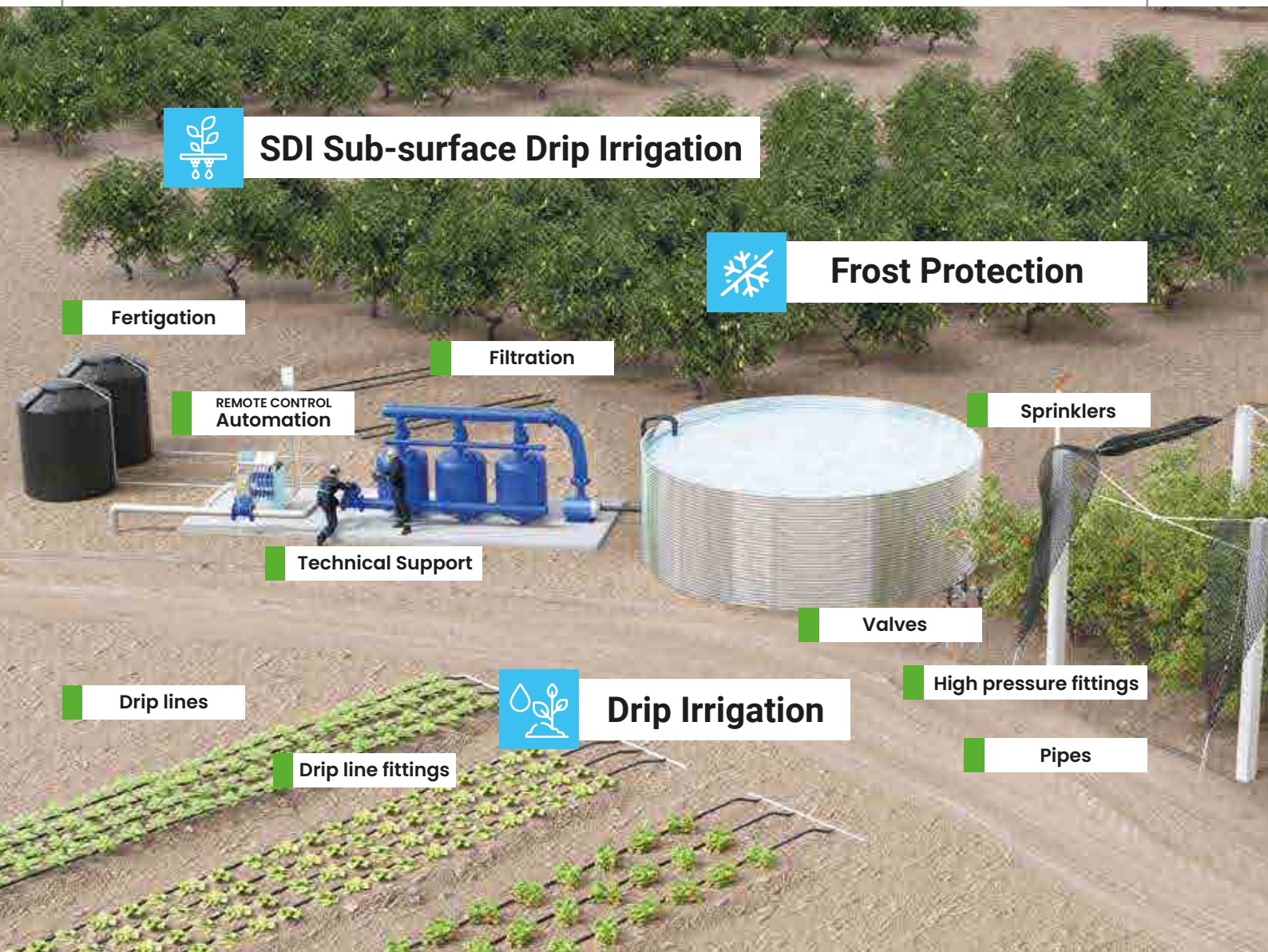

*Over 30 years  
in business*

INTEGRITY · DIVERSITY · SIMPLICITY



# PIPES

---

Variety of Polyethylene (PE) and other pipes for drinking water, irrigation, and telecommunication applications.

Our pipes made from top-quality virgin High-Density Polyethylene are ideal for potable water and high-pressure systems. For irrigation pipes, we use Low-Density Polyethylene which makes them more flexible and suitable for connecting a wide range of offtakes (starters), fittings, and drippers.

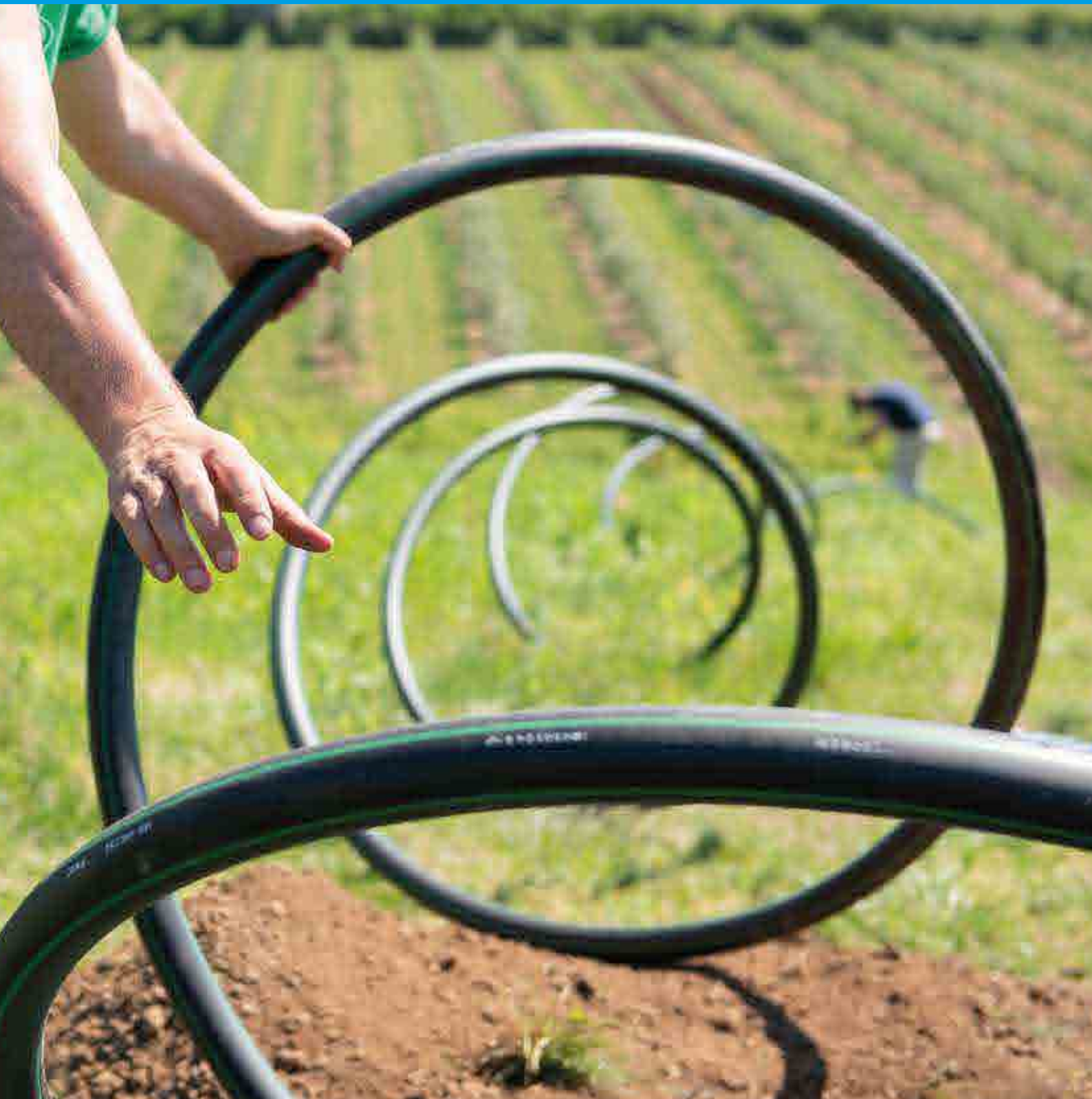





## Drinking water pipes

Made from first-class High-Density Polyethylene (HDPE), which has long-term strength properties (PE100). They are a safe way to transfer potable water. Long molecular chains make them suitable for high-pressure pipelines. They are characterized by a long service life and UV resistance.

PE100 pipes are available in the size Ø20 to Ø400 mm.

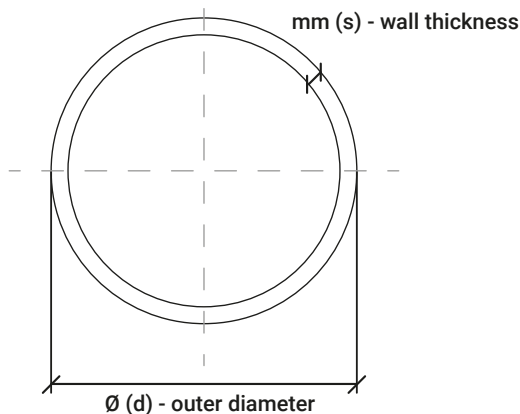

### Standard Dimension Ratio $SDR \cong d/s$

**Definition** - The numerical designation of pipe series is a convenient round number. Approximately equal to the dimension ratio of nominal outside diameter and the nominal wall thickness.

#### NOTE

ÉMI and DVGW certificates are valid for Ø20 mm - 225 mm

### Specifications and Technical data

<b>Diameter</b>	20 - 400 mm
<b>Color</b>	Black, with blue stripes
<b>Packaging</b>	50, 100, 200, 300, 500 m rolls, 6 m pipes, or custom made
<b>Operating Pressure</b>	10 – 16 bar
<b>Heat Resistance</b>	-20 – +40°C; however when used over +20°C the lifetime and pressure resistance is decreased <ul style="list-style-type: none"> <li>• Below +4°C becomes more rigid, and could be easily damaged;</li> <li>• Below -5°C is not recommended for installation</li> </ul>
<b>Thermal Dilatation</b>	0.2 mm/m/ °C
<b>Certification</b>	DVGW, ÖNORM, ÉME, UBA and OIB certificates
<b>Standard</b>	ISO 17885, EN 12201
<b>Field Of Use</b>	Cold-water pressure line networking
<b>Methods Of Connection</b>	<ul style="list-style-type: none"> <li>• PP Compression fittings</li> <li>• Butt fusion welding</li> <li>• Electrofusion fittings</li> </ul>

### Features

- Long lifetime (even 50 years when placed in the ground)
- UV resistant
- Accurate design and construction
- Appropriate size trench work, preparation of ballast



## Drinking Water PE100 Pipes

PE100 pipes are the third generation of pipe grade PE. Made from first-class High-Density Polyethylene, providing a safe way to transfer potable water. They are characterized by a long service life and UV resistance.

Connection: PP compression fittings, butt fusion welding, electro-fusion welding, and socket fusion.

Group 01015

### SDR11 - PN 16 BAR

Code	Package	Type	Price €	Stock
<b>Ø20 x 2.0 mm</b>				
01015025	100	Coil	0.691	✓
01015027	200	Coil	0.690	✗
01015032	300	Coil	0.689	✗
01015035	500	Coil	0.689	✗
<b>Ø25 x 2.3 mm</b>				
01015065	100	Coil	1.01	✓
01015067	200	Coil	1.01	✗
01015077	6	Rod	1.03	✗
<b>Ø32 x 3.0 mm</b>				
01015105	100	Coil	1.65	✓
01015107	200	Coil	1.65	✗
01015117	6	Rod	1.67	✗
<b>Ø40 x 3.7 mm</b>				
01015164	50	Coil	2.62	✗
01015165	100	Coil	2.54	✓
01015167	200	Coil	2.54	✗
01015177	6	Rod	2.56	✗
<b>Ø50 x 4.6 mm</b>				
01015223	50	Coil	3.93	✗
01015225	100	Coil	3.93	✓
01015237	6	Rod	3.96	✗

Code	Package	Type	Price €	Stock
<b>Ø63 x 5.8 mm</b>				
01015283	50	Coil	6.21	✗
01015285	100	Coil	6.21	✓
01015297	6	Rod	6.23	✗
<b>Ø75 x 6.8 mm</b>				
01015363	50	Coil	8.68	✗
01015365	100	Coil	8.67	✗
01015377	6	Rod	8.75	✗
<b>Ø90 x 8.2 mm</b>				
01015423	50	Coil	12.56	✗
01015425	100	Coil	12.56	✓
01015437	6	Rod	12.64	✗
<b>Ø110 x 10.0 mm</b>				
01015483	50	Coil	18.61	✗
01015485	100	Coil	18.61	✗
01015497	6	Rod	18.70	✗
<b>Ø125 x 11.4 mm</b>				
01015557	6	Rod	24.13	✗
<b>Ø140 x 12.7 mm</b>				
01015617	6	Rod	30.08	✗
<b>Ø160 x 14.6 mm</b>				
01015677	6	Rod	39.48	✗

Code	Package	Type	Price €	Stock
<b>Ø180 x 16.4 mm</b>				
01015737	6	Rod	49.88	✗
<b>Ø200 x 18.2 mm</b>				
01015797	6	Rod	61.50	✗
<b>Ø225 x 20.5 mm</b>				
01015820	6	Rod	77.83	✗
<b>Ø250 x 22.7 mm</b>				
01015850	6	Rod	95.71	✗
<b>Ø280 x 25.4 mm</b>				
01015833	6	Rod	134.80	✗
<b>Ø315 x 28.6 mm</b>				
01015843	6	Rod	170.62	✗
<b>Ø355 x 32.2 mm</b>				
01015853	6	Rod	216.59	✗
<b>Ø400 x 36.3 mm</b>				
01015893	6	Rod	274.95	✗

Group 01015

### SDR 13.6 - PN 12.5 BAR

Code	Package	Type	Price €	Stock
<b>Ø25 x 2.0 mm</b>				
01015045	100	Coil	0.879	✓
01015047	200	Coil	0.878	✗

Code	Package	Type	Price €	Stock
<b>Ø32 x 2.4 mm</b>				
01015145	100	Coil	1.25	✓
01015147	200	Coil	1.25	✓

Group 01015

### SDR 17 - PN 10 BAR

Code	Package	Type	Price €	Stock
<b>Ø32 x 2.0 mm</b>				
01015085	100	Coil	1.15	✓
01015087	200	Coil	1.15	✓
01015097	6	Rod	1.17	✓
<b>Ø40 x 2.4 mm</b>				
01015145	100	Coil	1.74	✓
01015147	200	Coil	1.74	✓
<b>Ø50 x 3.0 mm</b>				
01015203	50	Coil	2.67	✗
01015205	100	Coil	2.67	✓
<b>Ø63 x 3.8 mm</b>				
01015263	50	Coil	4.24	✗
01015265	100	Coil	4.24	✓
01015277	6	Rod	4.27	✗
<b>Ø75 x 4.5 mm</b>				
01015343	50	Coil	6.00	✗
01015345	100	Coil	5.99	✓
01015357	6	Rod	6.07	✓

Code	Package	Type	Price €	Stock
<b>Ø90 x 5.4 mm</b>				
01015403	50	Coil	8.62	✗
01015405	100	Coil	8.61	✓
01015417	6	Rod	8.70	✓
<b>Ø110 x 6.6 mm</b>				
01015463	50	Coil	12.81	✗
01015465	100	Coil	12.80	✓
01015477	6	Rod	12.79	✓
<b>Ø125 x 7.4 mm</b>				
01015537	6	Rod	16.32	✗
<b>Ø140 x 8.3 mm</b>				
01015597	6	Rod	20.48	✗
<b>Ø160 x 9.5 mm</b>				
01015657	6	Rod	26.72	✗
<b>Ø180 x 10.7 mm</b>				
01015717	6	Rod	33.80	✗
<b>Ø200 x 11.9 mm</b>				
01015777	6	Rod	41.69	✗



Code	Package	Type	Price €	Stock
<b>Ø225 x 13.4 mm</b>				
01015810	6	Rod	52.87	✗
<b>Ø250 x 14.8 mm</b>				
01015840	6	Rod	64.78	✗
<b>Ø280 x 16.6 mm</b>				
01015832	6	Rod	91.42	✗
<b>Ø315 x 18.7 mm</b>				
01015842	6	Rod	115.76	✗
<b>Ø355 x 21.1 mm</b>				
01015852	6	Rod	147.02	✗
<b>Ø400 x 23.7 mm</b>				
01015892	6	Rod	186.17	✗



# Irrigation Pipes

Irrigation pipes are produced from a softer material for easier installation. High impact resistance and weathering, make it ideal for the most demanding application. Unlike steel, PE Pipes can easily bypass obstacles in their path and withstand movements in the ground around them. The field of use is turf irrigation, open-field irrigation, and greenhouses.

Connection: Mechanical fittings (PP Compression fittings, Clamp saddles, Dripline fittings, Barbed fittings, etc.)

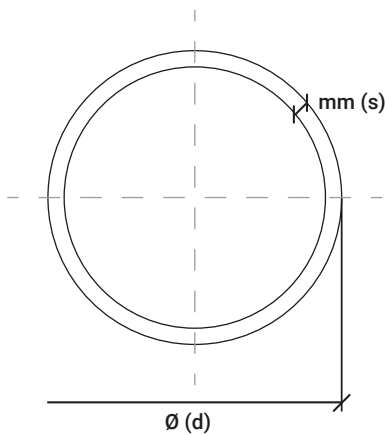

## Features

- Long lifetime
- UV resistant
- Accurate design and construction
- Appropriate size trench work, preparation of ballast

Specifications and Technical data	
<b>Diameter</b>	12 - 200 mm
<b>Color</b>	Black, with green stripes
<b>Packaging</b>	50, 100, 200, 300, 500 m rolls, 6 m pipes, or custom made
<b>Operating Pressure</b>	3.2 – 10 bar
<b>Heat Resistance</b>	-20 – +40°C; however when used over +20°C the lifetime and pressure resistance is decreased  Below +4°C becomes more rigid, and could be easily damaged;  Below -5°C is not recommended for installation
<b>Thermal Dilatation</b>	0.2 mm/m/ C
<b>Field Of Use</b>	Cold-water pressure line networking
<b>Methods Of Connection</b>	<ul style="list-style-type: none"> <li>• Mechanical fittings</li> <li>• PP Compression fittings</li> <li>• Clamp saddles</li> <li>• Dripline fittings</li> </ul>
<b>Standard</b>	ISO 8779



## Agricultural PE Pipes

Produced from a softer material. High impact resistance and weathering, make it ideal for the most demanding application. Unlike steel, PE Pipes can easily bypass obstacles in their path and withstand movements in the ground around them. The field of use is turf irrigation, open-field irrigation, and greenhouses.

Group 01030 / 01040

### PN 3.2 BAR

Code	Package	Type	Price €	Stock
<b>Size : Ø12 x 1.0 mm</b>				
01030013	100	Coil	0.153	✗
01030015	200	Coil	0.153	✗
01030017	300	Coil	0.153	✗
01030019	500	Coil	0.153	✗
<b>Size: Ø16 x 1.0 mm</b>				
01030023	100	Coil	0.206	✓
01030025	200	Coil	0.206	✗
01030027	300	Coil	0.200	✗
01030029	500	Coil	0.200	✓
<b>Size: Ø18 x 1.1 mm</b>				
01030053	100	Coil	0.247	✓
01030055	200	Coil	0.247	✗
01030057	300	Coil	0.247	✗
01030059	500	Coil	0.247	✓

Code	Package	Type	Price €	Stock
<b>Size: Ø20 x 1.2 mm</b>				
01030073	100	Coil	0.311	✓
01030075	200	Coil	0.311	✗
01030077	300	Coil	0.311	✓
01030079	500	Coil	0.311	✓
01040010	6	Rod	0.329	✗
<b>Size: Ø25 x 1.4 mm</b>				
01030103	100	Coil	0.464	✓
01030105	200	Coil	0.464	✓
01030107	300	Coil	0.464	✓
01030109	500	Coil	0.464	✗
<b>Size: Ø32 x 1.7 mm</b>				
01030153	50	Coil	0.732	✗
01030155	100	Coil	0.710	✓
01030157	200	Coil	0.704	✓
01040040	6	Rod	0.728	✓

Code	Package	Type	Price €	Stock
<b>Size: Ø40 x 2.1 mm</b>				
01030225	100	Coil	1.100	✓
01030227	200	Coil	1.100	✓
01040060	6	Rod	1.120	✓
<b>Size: Ø50 x 2.6 mm</b>				
01030253	50	Coil	1.670	✗
01030255	100	Coil	1.670	✓
01030257	200	Coil	1.670	✗
01030252	6	Rod	1.690	✗
<b>Size: Ø63 x 3.2 mm</b>				
01030283	50	Coil	2.550	✗
01030285	100	Coil	2.550	✓
01030287	200	Coil	2.550	✗
01040100	6	Rod	2.580	✓

Group 01030 / 01040

### PN 6.3 BAR

Code	Package	Type	Price €	Stock
<b>Size : Ø16 x 1.4 mm</b>				
01030043	100	Coil	0.270	✓
01030045	200	Coil	0.270	✗
01030047	300	Coil	0.270	✗
<b>Size: Ø20 x 1.5 mm</b>				
01030083	100	Coil	0.376	✓
01030085	200	Coil	0.376	✗
01030087	300	Coil	0.376	✗
01030089	500	Coil	0.376	✓
01040020	6	Rod	0.388	✗
<b>Size: Ø25 x 1.7 mm</b>				
01030123	100	Coil	0.546	✓
01030125	200	Coil	0.546	✓
01030127	300	Coil	0.546	✗
01030129	500	Coil	0.546	✗
01040030	6	Rod	0.564	✓
<b>Size: Ø32 x 2.0 mm</b>				
01030173	50	Coil	0.859	✗
01030175	100	Coil	0.834	✓
01030177	200	Coil	0.834	✓
01040050	6	Rod	0.851	✓

Code	Package	Type	Price €	Stock
<b>Size: Ø40 x 2.5 mm</b>				
01030235	100	Coil	1.27	✓
01030237	200	Coil	1.27	✓
01040070	6	Rod	1.30	✓
<b>Size: Ø50 x 3.1 mm</b>				
01030263	50	Coil	1.94	✗
01030265	100	Coil	1.94	✓
01030267	200	Coil	1.94	✗
01040080	6	Rod	1.97	✓
<b>Size: Ø63 x 4.2 mm</b>				
01030293	50	Coil	2.97	✗
01030295	100	Coil	2.97	✓
01030297	200	Coil	2.97	✗
01040110	6	Rod	2.97	✓
<b>Size: Ø75 x 4.7 mm</b>				
01030313	50	Coil	4.34	✗
01030315	100	Coil	4.33	✓
01040130	6	Rod	4.39	✓

Code	Package	Type	Price €	Stock
<b>Size: Ø90 x 5.7 mm</b>				
01030333	50	Coil	6.30	✓
01030335	100	Coil	6.28	✓
01040150	6	Rod	6.35	✓
<b>Size: Ø110 x 6.9 mm</b>				
01030353	50	Coil	9.30	✗
01030355	100	Coil	9.29	✓
01040170	6	Rod	9.36	✓
<b>Size: Ø125 x 7.9 mm</b>				
01040190	6	Rod	11.98	✗
<b>Size: Ø160 x 10 mm</b>				
01040240	6	Rod	19.43	✗
<b>Size: Ø200 x 12.5 mm</b>				
01040270	6	Rod	30.35	✗

Group 01030 / 01040

**PN 10 BAR**

Code	Package	Type	Price €	Stock
<b>Size: Ø20 x 2.0 mm</b>				
01030093	100	Coil	0.493	✓
01030095	200	Coil	0.487	✗
01030097	300	Coil	0.487	✗
01030099	500	Coil	0.487	✗
<b>Size: Ø25 x 2.3 mm</b>				
01030133	100	Coil	0.710	✓
01030135	200	Coil	0.710	✗
01030137	300	Coil	0.710	✗
<b>Size: Ø32 x 3.0 mm</b>				
01030183	50	Coil	1.20	✗
01030185	100	Coil	1.17	✓
01030187	200	Coil	1.17	✗
<b>Size: Ø40 x 3.7 mm</b>				
01030245	100	Coil	1.78	✗
01030247	200	Coil	1.78	✗

Code	Package	Type	Price €	Stock
<b>Size: Ø50 x 4.6 mm</b>				
01030273	50	Coil	2.73	✗
01030275	100	Coil	2.73	✓
01040090	6	Rod	2.76	✓
<b>Size: Ø63 x 5.8 mm</b>				
01030303	50	Coil	4.29	✗
01030305	100	Coil	4.29	✓
01040120	6	Rod	4.29	✗
<b>Size: Ø75 x 7.0 mm</b>				
01030323	50	Coil	6.15	✗
01030325	100	Coil	6.14	✗
01040140	6	Rod	6.20	✗
<b>Size: Ø90 x 8.4 mm</b>				
01030343	50	Coil	8.84	✗
01030345	100	Coil	8.82	✓
01040160	6	Rod	8.90	✓

Code	Package	Type	Price €	Stock
<b>Size: Ø110 x 10.2 mm</b>				
01030363	50	Coil	13.11	✗
01030365	100	Coil	13.09	✓
01040180	6	Rod	13.17	✓
<b>Size: Ø125 x 11.6 mm</b>				
01040200	6	Rod	16.82	✗
<b>Size: Ø160 x 13 mm</b>				
01040260	6	Rod	27.64	✗
<b>Size: Ø200 x 18.6 mm</b>				
01040280	6	Rod	43.13	✗



## Irrigation LDPE pipes

Irrigation pipes, produced from low-density polyethylene raw material (LDPE) are used in a wide range of applications, including sprinkler & drip irrigation and agricultural & landscape irrigation systems. Thanks to their high resistance to mechanical stress, they apply to all mechanical fittings, especially for a connector with inserts (PP compression fittings, clamp saddles, dripline fittings, barbed fittings, etc.)

### Group 01035

#### PN 4 BAR

Code	Package	Type	Price €	Stock
<b>Size: Ø16 x 1.2 mm</b>				
01035071	25	Coil	0.235	✗
01035072	50	Coil	0.224	✗
01035073	100	Coil	0.218	✓
01035075	200	Coil	0.218	✗
<b>Size: Ø20 x 1.2 mm</b>				
01035091	25	Coil	0.299	✗
01035092	50	Coil	0.285	✗
01035093	100	Coil	0.276	✓
01035095	200	Coil	0.276	✗
<b>Size: Ø25 x 1.6 mm</b>				
01035111	25	Coil	0.457	✗
01035112	50	Coil	0.436	✗
01035113	100	Coil	0.423	✓
01035115	200	Coil	0.423	✗

Code	Package	Type	Price €	Stock
<b>Size: Ø32 x 2.0 mm</b>				
01035152	25	Coil	0.711	✗
01035153	50	Coil	0.677	✗
01035155	100	Coil	0.658	✓
01035157	200	Coil	0.658	✗
<b>Size: Ø40 x 2.4 mm</b>				
01035225	100	Coil	0.992	✓
01035227	200	Coil	0.992	✗

### Group 01035

#### PN 6.3 BAR

Code	Package	Type	Price €	Stock
<b>Size: Ø16 x 1.5 mm</b>				
01035081	25	Coil	0.273	✗
01035082	50	Coil	0.260	✗
01035083	100	Coil	0.253	✗
01035085	200	Coil	0.253	✗
<b>Size: Ø20 x 1.5 mm</b>				
01035101	25	Coil	0.362	✗
01035102	50	Coil	0.345	✗
01035103	100	Coil	0.335	✗
01035105	200	Coil	0.335	✗
<b>Size: Ø25 x 1.9 mm</b>				
01035121	25	Coil	0.533	✗
01035122	50	Coil	0.508	✗
01035123	100	Coil	0.493	✗
01035125	200	Coil	0.493	✗

Code	Package	Type	Price €	Stock
<b>Size: Ø32 x 2.5 mm</b>				
01035172	25	Coil	0.876	✗
01035173	50	Coil	0.834	✗
01035175	100	Coil	0.810	✗
01035177	200	Coil	0.810	✗
<b>Size: Ø40 x 3.2 mm</b>				
01035235	100	Coil	1.30	✗
01035237	200	Coil	1.30	✗



## White LDPE Pipes **NEW**

White LDPE pipes are primarily used in greenhouses since it reflects light, providing plants with enough light to grow adequately. It is used as a supply pipe for online drippers.

Group 01035

### WHITE LDPE PIPE PN 6 BAR

Code	Package	Type	Price €	Stock
<b>Size : Ø16 x 1.5 mm</b>				
01035084	100	Coil	0.300	✘
<b>Size : Ø20 x 1.5 mm</b>				
01035107	100	Coil	0.394	✘
<b>Size : Ø25 x 1.9 mm</b>				
01035124	100	Coil	0.587	✘
<b>Size : Ø32 x 2.5 mm</b>				
01035176	100	Coil	0.974	✘
<b>Size : Ø40 x 3.2 mm</b>				
01035236	100	Coil	1.540	✘

Cikkcsoport 01035

### WHITE LDPE PIPE PN 4 BAR

Code	Package	Type	Price €	Stock
<b>Size : Ø20 x 1.2 mm</b>				
01035094	100	Coil	0.314	✘

White LDPE pipes we **DO NOT** keep on stock.  
For more information contact our sales department



Obtain water temperature



Prevents Algae



UV Resistant



Operating Pressure 6 bar



Multiple diameters

### Features & Benefits

- Reflects light instead of absorbing it
- Maintains water at a temperature below that of a black polyethylene pipe
- Prevents the growth of algae and bacteria
- Triggers less dilatation and contraction than a black pipe
- Slows down the chemical precipitation reaction
- Maximizes light reflection in greenhouses
- Made of solid, durable polyethylene

### NOTE

#### Transport Packaging:

Pallet dimensions - pipe diameters 16, 32 and 40 is 120x120  
- pipe diameters 20 and 25 is 80x150

Pipe diameter 16: Ø62 cm x 15 cm height - 100m roll  
2400m / pallet  
120x120 pallet size: 110 cm height

Pipe diameter 20: Ø80 cm x 13 cm height - 100m roll  
1600m / pallet  
150x80 pallet size: 130 cm height



## Group 01500

**LAYFLAT PIPES**

Code	Diameter	Pressure	Package	Price €	Stock
01500010	53 mm (2")	6.5 bar	100	2.81	✓
01500020	78 mm (3")	5 bar	100	4.19	✓
01500040	103 mm (4")	3 bar	100	4.92	✓
01500030	103 mm (4")	4 bar	100	6.25	✓

Type of connection: Layflat fittings.

Find out more on page **40**

The flat hose on flexible PVC is impregnated with polyester reinforcement in one layer. The polyester reinforcement is manufactured between 2 layers of PVC with an anti-delamination system and with reinforced traction capacity.

## Advantages:

- Free of industrial waste
- Decreases stretching under pressure
- Anti-delamination
- Perfect for irrigation
- Stretching resistant
- Traction resistant
- Perfect adhesion between layers

+55°C  
-10°C

TEMPERATURE



RESISTANT



FLEXIBLE



LIGHT



## Group 01400

**PVC MICROTUBE**

Code	Type (ID x Wall)	Package	Price €	Stock
01400040	3.0 x 1.0	300	0.147	✓
01400050	3.0 x 1.1	300	0.165	✓
01400060	3.75 x 1.5	200	0.294	✓
01400070	4.0 x 1.5	200	0.311	✓
01400080	7.0 x 1.5	50	0.476	✓
01400090	8.0 x 2.5	50	0.968	✓

ID - Tube inner diameter in mm

Wall - Tube wall thickness in mm

Type of connection: Sprinkler accessories.

Find out more on page **101**

PVC microtubes are used in low-pressure localized irrigation systems, connected to micro-sprinklers and micro-sprayers with the main pipeline, or from drip emitters directly to the plant. Available inside diameters are from 3 mm to 8 mm, and wall thickness from 1 mm to 2.5 mm, depending on the microtube type.



## Group 01070

**FLEX PIPE FOR POP-UP D16 10 BAR**

Code	Size	Package	Price €	Stock
01070070	16x1.9 mm	25	0.405	✓
01070080	16x1.9 mm	50	0.386	✓
01070030	16x1.9 mm	100	0.375	✓
01070040	16x1.9 mm	200	0.375	✓

Type of connection: Elbow for pop-up and Elbow for pop-up (Spiral barb).

Find out more on page **51**



This type of pipe is used to make irrigation with Pop-up sprinkler connections. Flex pipe simplifies sprinkler installation, relocation, replacement, and repair. Provides flexibility for better positioning to the desired location and to get around the obstacles and buffer sprinkler protecting it against damage.

Available packages: 25 m, 50 m, 100 m, and 200 m rolls.



# High Pressure Fittings

Fittings manufactured from high-quality plastic are suitable for setting up the water supply and irrigation systems. Poliext provides the whole range of fittings and adapters for high-pressure applications, specially designed to match the performance of our valves and tubing (compression fittings, clamp saddles, threaded fittings, manifold fittings, lay flat fittings, etc.)





## PP Compression Fittings PN16

PP compression fittings PN16 are designed especially for connection polyethylene (PE) pipes. These fittings are compatible with all PE80 and PE100 pipes, according to EN12201.

Our range of compression fittings allows a fast and secure connection of polyethylene tubing for any industrial, commercial or domestic need. Available in diameter from 16 mm to 110 mm and with a maximum operating pressure of 16 bar.

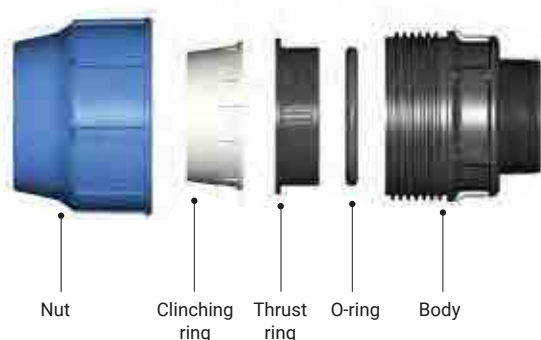

### Specifications and Technical data

<b>Size</b>	16-110 mm
<b>Nut</b>	Blue Polypropylene (PP)
<b>Clinching Ring</b>	Polyacetal (POM)
<b>Thrust Ring</b>	Special elastomeric nitrile rubber (NBR)
<b>O ring - gasket</b>	Ethylene propylene diene monomer rubber (EPDM)
<b>Body</b>	Black Polypropylene (PP)
<b>Reinforcing metal ring</b>	Galvanized steel
<b>Operating Pressure</b>	16 bar
<b>Design</b>	ISO 17885
<b>Size</b>	ISO 3126
<b>Threads</b>	ISO 7-1
<b>Markings</b>	ISO 17885
<b>Quality Management</b>	ISO 9001
<b>Pipes Suitability</b>	Polyethylene pipe PE80 and PE100
<b>Effect on water quality</b>	According to national regulations
<b>Pull out resistance</b>	ISO 3501
<b>Resistance to internal pressure when subject is bended</b>	ISO 3503, DIN8076
<b>Resistance to internal pressure (1 hour)</b>	ISO 3459, DIN8076
<b>Resistance to internal pressure (100 hours)</b>	ISO13846, ISO 1167, DIN8076

### Features

- Certified by DVGW and produced according to EU norms and standards
- Produced from primer raw material. Certified for drinking/potable water
- Precise threads, according to EU standards
- Excellent long-term pressure resistance
- High-quality O-ring, coated with silicone
- Strong clinching ring
- Female fittings are with reinforcing metal ring
- Fitting nut has 4-6 threads, providing stronger connection and better pull-out characteristics

### NOTE

DVGW, KIWA, UBA, OIB, ÉMI and ITC certificates are valid for Ø20 mm to Ø75 mm

## Group 02050

## PP COUPLING



Code	Size	Bag	Box	Price €	Stock
02050120	16x16	20	280 P2	1.11	✓
02050010	20x20	20	160 P2	1.50	✓
02050020	25x25	10	80 P2	1.75	✓
02050030	32x32	10	60	2.28	✓
02050040	40x40	5	40 P2	3.67	✓
02050050	50x50	5	30 P3	5.03	✓
02050060	63x63	-	10 P2	6.92	✓
02050070	75x75	-	9 P2	13.06	✓
02050080	90x90	-	8 P3	22.49	✓
02050100	110x110	-	6 P4	37.67	✓

## Group 02010

## PP MALE ADAPTOR



Code	Size	Bag	Box	Price €	Stock
02010280	16x1/2"	20	480 P2	0.718	✓
02010290	16x3/4"	20	400 P2	0.719	✓
02010010	20x1/2"	20	280 P2	0.822	✓
02010020	20x3/4"	20	280 P2	0.849	✓
02010030	25x1/2"	10	160 P2	0.988	✓
02010040	25x3/4"	10	140 P2	0.969	✓
02010050	25x1"	10	140 P2	0.988	✓
02010270	32x1/2"	10	100 P2	1.26	✓
02010060	32x3/4"	10	100 P2	1.26	✓
02010070	32x1"	10	100 P2	1.22	✓
02010080	32x5/4"	10	100 P2	1.55	✓
02010090	40x1"	5	60 P2	2.29	✓
02010100	40x5/4"	5	60 P2	2.29	✓
02010110	40x6/4"	5	50 P2	2.29	✓
02010120	50x5/4"	5	30 P2	3.00	✓
02010130	50x6/4"	5	30 P2	3.00	✓
02010140	50x2"	5	30 P2	3.00	✓
02010150	63x6/4"	-	25 P3	4.25	✓
02010160	63x2"	-	25 P3	4.25	✓
02010170	63x2 1/2"	-	25 P3	4.25	✓
02010180	75x2"	-	12 P2	8.48	✓
02010190	75x2 1/2"	-	12 P2	8.48	✓
02010300	90x2"	-	14 P3	13.29	✓
02010310	90x2 1/2"	-	14 P3	12.64	✓
02010220	90x3"	-	14 P3	13.34	✓
02010320	90x4"	-	13 P3	13.32	✓
02010330	110x3"	-	7 P3	20.14	✓
02010260	110x4"	-	7 P3	20.24	✓

## Group 02060

## PP REDUCING COUPLING



Code	Size	Bag	Box	Price €	Stock
02060180	20x16	20	200 P2	1.55	✓
02060010	25x20	10	120 P2	1.60	✓
02060020	32x25	10	80 P2	2.05	✓
02060170	40x25	5	50 P2	3.58	✓
02060030	40x32	5	45 P2	3.58	✓
02060050	50x40	5	25 P2	4.84	✓
02060160	63x32	-	15 P2	6.51	✓
02060150	63x40	-	15 P2	6.51	✓
02060080	63x50	-	10 P2	6.55	✓
02060090	75x63	-	9 P2	11.92	✓
02060190	90x63	-	11 P3	17.86	✓
02060200	90x75	-	11 P3	18.92	✓
02060210	110x75	-	6 P3	39.97	✓
02060140	110x90	-	5 P3	36.84	✓

## Group 02020

## PP FEMALE ADAPTOR



Code	Size	Bag	Box	Price €	Stock
02020220	16x1/2"	20	500 P2	0.821	✓
02020230	16x3/4"	20	400 P2	0.823	✓
02020010	20x1/2"	20	200 P2	1.14	✓
02020020	20x3/4"	20	200 P2	1.14	✓
02020030	25x1/2"	10	140 P2	1.33	✓
02020040	25x3/4"	10	120 P2	1.33	✓
02020050	25x1"	10	120 P2	1.33	✓
02020210	32x1/2"	10	80 P2	1.56	✓
02020060	32x3/4"	10	80 P2	1.56	✓
02020070	32x1"	10	80 P2	1.56	✓
02020080	40x1"	5	60 P2	2.67	✓
02020090	40x5/4"	5	50 P2	2.67	✓
02020100	40x6/4"	5	50 P2	2.67	✓
02020110	50x6/4"	5	25 P2	3.50	✓
02020120	63x6/4"	-	15 P2	4.97	✓
02020130	63x2"	-	15 P2	4.97	✓
02020140	75x2"	-	12 P2	9.93	✓
02020150	75x2 1/2"	-	12 P2	9.93	✓
02020170	90x3"	-	14 P3	15.70	✓
02020185	110x3"	-	7 P3	28.23	✓
02020200	110x4"	-	7 P3	28.23	✓

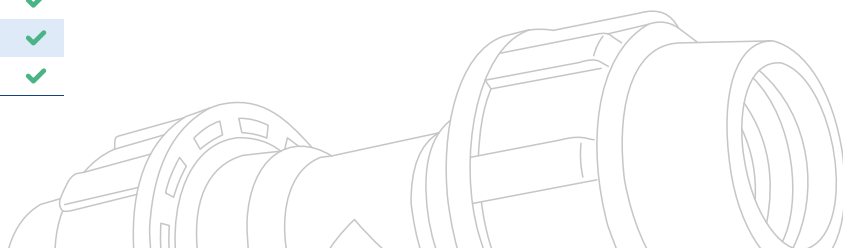

Group 02070

**PP END PLUG**



Code	Size	Bag	Box	Price €	Stock
02070120	16	20	480 P2	0.787	✓
02070010	20	20	320 P2	0.988	✓
02070020	25	10	140 P2	1.10	✓
02070030	32	10	120 P2	1.35	✓
02070040	40	5	70 P2	2.28	✓
02070050	50	5	30 P2	3.34	✓
02070060	63	-	20 P2	4.53	✓
02070070	75	-	15 P2	10.48	✓
02070090	90	-	9 P2	13.31	✓
02070110	110	-	5 P2	26.33	✓

Group 02040

**PP FLANGED ADAPTOR**



Code	Size	Bag	Box	Price €	Stock
02040010	63x2"	-	18 P3	15.20	✓
02040020	75x2 1/2	-	4 P3	20.27	✓
02040030	75x3"	-	8 P3	21.93	✓
02040050	90x3"	-	8 P3	39.87	✓
02040080	110x4"	-	4 P3	58.99	✓

Group 02090

**PP MALE ELBOW**



Code	Size	Bag	Box	Price €	Stock
02090220	16x1/2"	20	400 P2	1.02	✓
02090230	16x3/4	20	360 P2	0.950	✓
02090010	20x1/2"	20	280 P2	1.08	✓
02090020	20x3/4	20	280 P2	1.08	✓
02090050	25x1/2"	10	120 P2	1.20	✓
02090060	25x3/4"	10	120 P2	1.20	✓
02090070	25x1"	10	120 P2	1.20	✓
02090090	32x3/4"	10	90 P2	1.55	✓
02090110	32x1"	10	80 P2	1.55	✓
02090120	40x5/4"	5	45 P2	2.47	✓
02090130	50x6/4"	5	20 P2	3.34	✓
02090150	63x2"	-	20 P3	4.63	✓
02090160	75x2 1/2"	-	8 P2	8.45	✓
02090250	90x2 1/2"	-	12 P4	17.48	✓
02090180	90x3"	-	9 P3	17.29	✓
02090185	90x4"	-	8 P3	16.65	✓
02090270	110x3"	-	6 P3	26.83	✓
02090210	110x4"	-	6 P3	26.83	✓

Group 02070

**PP END PLUG WITH VALVE**

Operating pressure 6 bar



Code	Size	Bag	Box	Price €	Stock
02070210	20	20	300 P2	1.12	✓
02070220	25	10	120 P2	1.38	✓
02070230	32	10	120 P2	1.80	✓
02070240	40	5	70 P2	3.00	✓
02070250	50	5	30 P2	4.43	✓
02070260	63	-	20 P2	7.22	✓

Group 02030

**PP COUPLING WITH O-RING**

Operating pressure 10 bar



Code	Size	Bag	Box	Price €	Stock
02030020	25x1"	10	110 P2	2.17	✓
02030040	32x1"	10	80 P2	2.04	✓
02030060	40x1"	5	50 P2	2.85	✓

Group 02100

**PP FEMALE ELBOW**



Code	Size	Bag	Box	Price €	Stock
02100210	16x1/2"	20	400 P2	1.21	✓
02100220	16x3/4"	20	300 P2	1.13	✓
02100010	20x1/2"	20	220 P2	1.29	✓
02100030	20x3/4"	20	200 P2	1.35	✓
02100050	25x1/2"	10	120 P2	1.63	✓
02100060	25x3/4"	10	120 P2	1.63	✓
02100070	25x1"	10	100 P2	1.72	✓
02100100	32x3/4"	10	90 P2	1.93	✓
02100110	32x1"	10	80 P2	1.97	✓
02100120	40x5/4"	5	40 P2	3.79	✓
02100130	50x6/4"	5	20 P2	5.05	✓
02100140	63x2"	-	20 P3	6.82	✓
02100150	75x2 1/2"	-	8 P2	12.22	✓
02100170	90x3"	-	8 P3	21.94	✓
02100180	110x3"	-	7 P3	33.27	✓
02100200	110x4"	-	5 P3	34.45	✓

Group 02110

**PP WALL SUPPORT ELBOW**



Code	Size	Bag	Box	Price €	Stock
02110010	20x1/2"	20	120 P2	3.00	✓
02110040	25x3/4"	10	60 P2	3.39	✓

## Group 02080

## PP ELBOW



Code	Size	Bag	Box	Price €	Stock
02080120	16x16	20	240 P2	1.19	✓
02080010	20x20	20	160 P2	1.48	✓
02080020	25x25	10	70 P2	1.80	✓
02080030	32x32	10	50 P2	2.24	✓
02080040	40x40	5	40 P3	3.88	✓
02080050	50x50	5	15 P2	5.41	✓
02080060	63x63	-	12 P3	6.55	✓
02080070	75x75	-	6 P2	12.67	✓
02080090	90x90	-	9 P4	25.69	✓
02080110	110x110	-	6 P4	35.41	✓

## Group 02130

## PP TEE COUPLING



Code	Size	Bag	Box	Price €	Stock
02130120	16x16x16	20	160 P2	1.56	✓
02130010	20x20x20	20	100 P2	1.92	✓
02130020	25x25x25	10	40 P2	2.62	✓
02130030	32x32x32	10	50 P3	3.31	✓
02130040	40x40x40	-	30 P3	5.41	✓
02130050	50x50x50	-	10 P2	7.32	✓
02130060	63x63x63	-	8 P3	10.38	✓
02130070	75x75x75	-	6 P3	18.05	✓
02130090	90x90x90	-	7 P4	35.64	✓
02130110	110x110x110	-	4 P4	52.44	✓

## Group 02140

## PP REDUCING TEE



Code	Size	Bag	Box	Price €	Stock
02140120	16x20x16	20	160 P2	2.35	✓
02140130	20x16x20	20	120 P2	2.31	✓
02140020	25x20x25	10	50 P2	2.66	✓
02140090	25x32x25	10	40 P2	3.47	✓
02140040	32x25x32	10	50 P3	3.47	✓
02140050	40x32x40	5	35 P3	5.49	✓
02140100	50x32x50	5	25 P3	8.09	✓
02140060	50x40x50	5	25 P3	8.09	✓
02140110	63x40x63	-	15 P3	9.82	✓
02140070	63x50x63	-	14 P3	9.82	✓
02140080	110x90x110	-	4 P4	62.38	✓

## Group 02150

## PP MALE TEE



Code	Size	Bag	Box	Price €	Stock
02150190	16x1/2"x16	20	200 P2	1.58	✓
02150200	16x3/4"x16	20	200 P2	1.58	✓
02150010	20x1/2"x20	20	120 P2	1.64	✓
02150020	20x3/4"x20	20	120 P2	1.64	✓
02150030	25x1/2"x25	10	60 P2	2.09	✓
02150040	25x3/4"x25	10	60 P2	2.09	✓
02150060	25x1"x25	10	60 P2	2.09	✓
02150070	32x3/4"x32	10	50 P2	2.68	✓
02150090	32x1"x32	10	40 P2	2.68	✓
02150100	40x1"x40	5	40 P3	4.65	✓
02150110	40x5/4"x40	5	35 P3	4.65	✓
02150120	50x6/4"x50	5	10 P2	6.53	✓
02150130	63x2"x63	-	12 P3	12.65	✓
02150140	75x2 1/2"x75	-	9 P3	17.83	✓
02150220	90x2 1/2"x90	-	6 P3	27.92	✓
02150160	90x3"x90	-	6 P3	27.68	✓
02150230	90x4"x90	-	6 P3	27.28	✓
02150180	110x4"x110	-	6 P4	41.95	✓

## Group 02160

## PP FEMALE TEE



Code	Size	Bag	Box	Price €	Stock
02160210	16x1/2"x16	20	200 P2	1.73	✓
02160220	16x3/4"x16	20	160 P2	1.50	✓
02160010	20x1/2"x20	20	120 P2	1.89	✓
02160030	20x3/4"x20	20	100 P2	1.87	✓
02160200	25x1/2"x25	10	60 P2	2.55	✓
02160040	25x3/4"x25	10	60 P2	2.45	✓
02160060	25x1"x25	10	60 P2	2.39	✓
02160070	32x3/4"x32	10	60 P3	3.17	✓
02160090	32x1"x32	10	60 P3	3.17	✓
02160100	40x1"x40	5	40 P3	5.34	✓
02160110	40x5/4"x40	5	40 P3	5.34	✓
02160120	50x6/4"x50	5	12 P2	7.55	✓
02160130	63x2"x63	-	10 P3	14.66	✓
02160140	75x2 1/2"x75	-	8 P3	20.68	✓
02160160	90x3"x90	-	5 P3	34.34	✓
02160190	110x4"x110	-	5 P4	45.91	✓

Group 02120

**PP FLANGED ELBOW**



Code	Size	Bag	Box	Price €	Stock
02120010	75x2,1/2"	-	8 P3	23.76	✓
02120020	75x3"	-	10 P3	25.51	✓
02120035	90x3"	-	8 P3	45.78	✓
02120040	90x4"	-	5 P3	38.74	✓
02120045	110x4"	-	6 P3	63.56	✓

Group 02170

**PP FLANGED TEE**



Code	Size	Bag	Box	Price €	Stock
02170010	75x2 1/2"	-	7	32.46	✓
02170020	75x3"	-	5	34.21	✓
02170035	90x3"	-	6	57.19	✓
02170040	90x4"	-	5	51.55	✓
02170045	110x4"	-	4	75.57	✓

Group 02010

**PP MALE ADAPTOR (LONG THREAD)**



Code	Size	Bag	Box	Price €	Stock
02010340	50x6/4"	5	30 P2	3.66	✓

Group 02020

**PP FEMALE ADAPTOR (LONG THREAD)**



Code	Size	Bag	Box	Price €	Stock
02020240	50x6/4"	5	25 P2	4.47	✓

Group 02300

**NUT**



Code	Size	Bag	Box	Price €	Stock
02300660	16	-	-	0.332	✓
02300200	20	-	-	0.366	✓
02300220	25	-	-	0.570	✓
02300240	32	-	-	0.588	✓
02300260	40	-	-	0.854	✓
02300280	50	-	-	1.35	✓
02300300	63	-	-	4.04	✓
02300440	75	-	-	4.86	✓
02300590	90	-	-	7.49	✓
02300600	110	-	-	8.90	✓

Group 02300

**CLINCHING RING**



Code	Size	Bag	Box	Price €	Stock
02300670	16	-	-	0.088	✓
02300110	20	-	-	0.123	✓
02300120	25	-	-	0.198	✓
02300130	32	-	-	0.217	✓
02300140	40	-	-	0.308	✓
02300150	50	-	-	0.502	✓
02300160	63	-	-	0.791	✓
02300170	75	-	-	1.12	✓
02300610	90	-	-	1.89	✓
02300620	110	-	-	2.53	✓

Group 02300

**THRUST RING**



Code	Size	Bag	Box	Price €	Stock
02300680	16	-	-	0.076	✓
02300020	20	-	-	0.094	✓
02300030	25	-	-	0.098	✓
02300040	32	-	-	0.117	✓
02300050	40	-	-	0.178	✓
02300060	50	-	-	0.332	✓
02300070	63	-	-	0.506	✓
02300080	75	-	-	0.602	✓
02300570	90	-	-	1.69	✓
02300580	110	-	-	1.89	✓

Group 02300

**O RING - GASKET**



Code	Size	Bag	Box	Price €	Stock
02300690	16	-	-	0.045	✓
02300320	20	-	-	0.097	✓
02300330	25	-	-	0.111	✓
02300350	32	-	-	0.138	✓
02300360	40	-	-	0.316	✓
02300370	50	-	-	0.343	✓
02300380	63	-	-	0.478	✓
02300390	75	-	-	0.601	✓

**Flange**

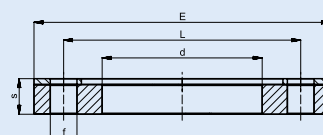
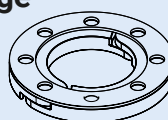

DN	Ø	E	d	L	f	s	Number of Holes
80	3"	200	108	160	18	24	8
100	4"	225	133	185	18	29	8

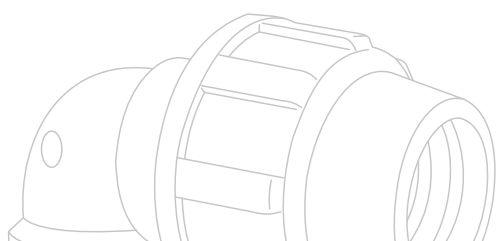

### ASSEMBLING INSTRUCTIONS

#### Assembling instruction for fittings Ø16 - Ø40 mm



Limber up the nut, but do not remove it completely.



Insert the pipe into the fitting. Make sure that the pipe crossed the O ring - gasket.



Fully coil back the nut.



Assembled PP fitting.

#### Assembling instruction for fittings Ø50 - Ø110 mm

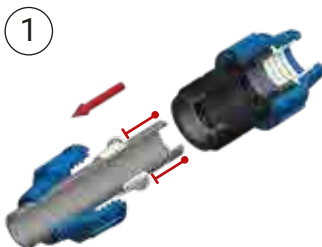

Pull up the nut, the clinching ring, the thrust ring, and O-ring on the pipe.

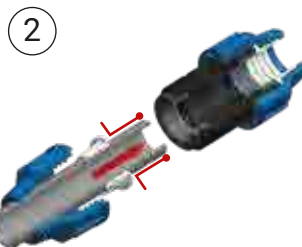

Put together the pipe, O-ring, and thrust ring into the body. Push the pipe until the internal register is inside a fitting. Make sure that O-ring and thrust ring are in their original position.



Pull back the clinching ring to its original position.



Pull back the nut and fully coil it up to the fitting.

#### Proposal for easier installation for fittings Ø90 - Ø110 mm



Pull up the nut, the clinching ring, the thrust ring, and O-ring on the pipe.



Place the pipe into the body of the fitting. O-ring and thrust ring are pushed into place, fully winding the nut.



Uncoil the nut, then stretch the clinching ring and place it into the pipe right next to the thrust ring.



Pull back the clinching ring to its original position.

### IMPORTANT

- The end of the pipe has to be chamfered and cleaned from chips.
- From Ø20 mm to Ø40 mm is enough to coil the nut by hand.
- If the nut is not fixed completely, there can be dripping or flowing at the O ring-gasket or the pressure can set off the pipe from the fitting.
- The threaded end of the PP fitting has to be covered with PTFE (polytetrafluoroethylene) tape or braid.
- The threaded end of PP fitting has to be coiled in completely (useful thread length).
- Above 50 mm diameter, a wrench or tool has to be used to reach the perfect bonding.

- Torque values for tightening nut:

DN	16	20	25	32	40	50	63	75	90	110
Nm	6.5	8	15	18	28	40	65	110	140	240

- Fittings Ø90 - 110 mm:
  - Position the pipe app 5 mm from the internal register, while tightening the nut, it will push together the clinching ring thrust ring, O-ring, and the pipe to the right position.
  - Tighten the nut and make sure that the nut exceeds the last thread of the body, until a 1 - 2 mm gap is left next to the fitting edge.



## PP Compression Fittings PN10

PP Compression fittings PN10 are specially designed for connecting polyethylene (PE) pipes. They are compatible with all pipes according to EN 12201. Available in diameter from 16 mm up to 63 mm and with a maximum operating pressure of 10 bar.

### Specifications and Technical data

Size	16 - 63 mm
Body	Black Polypropylene (PP)
Nut	Green Polypropylene (PP)
Clinching Ring	Polyacetal (POM)
Thrust Ring	Black Polypropylene (PP)
O ring - gasket	Special elastomeric nitrile rubber (NBR)
Operating Pressure	10 bar
Pipe Suitability	Polyethylene (PE) pipe, PE80, and PE100, In accordance with EN 1220
<b>Reference standards</b>	
Design	ISO 17885
Markings	ISO 17885
Size	ISO 3126
Threads	ISO 7-1
Internal pressure resistance (1 hour)	ISO 3485
Pull-out resistance	ISO 3501

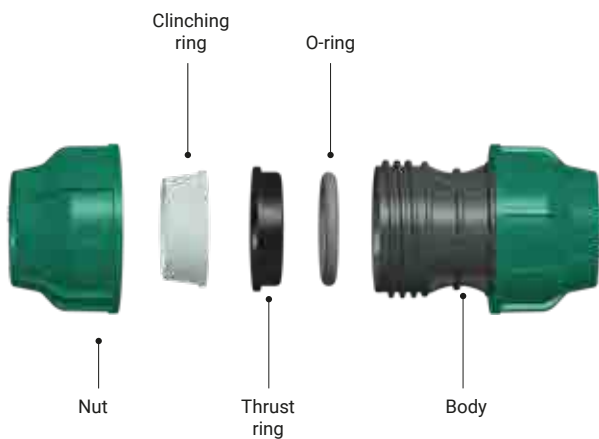

### Features

- Top product quality and reliability
- Excellent price-quality ratio
- Produced according to EU standards
- Strong fitting, excellent pressure resistance, and long-life cycle
- Easy assembling and reassembling



## Group 03020

## PP FEMALE ADAPTOR



Code	Size	Bag	Box	Price €	Stock
03020181	16x1/2"	20	500 P2	0.648	✓
03020191	16x3/4"	20	400 P2	0.648	✓
03020011	20x1/2"	20	500 P2	0.663	✓
03020021	20x3/4"	20	400 P2	0.663	✓
03020031	25x1/2"	20	240 P2	0.768	✓
03020041	25x3/4"	20	280 P2	0.770	✓
03020051	25x1"	20	240 P2	0.768	✓
03020161	32x1/2"	20	200 P2	0.960	✓
03020061	32x3/4"	20	200 P2	0.960	✓
03020071	32x1"	20	160 P2	0.960	✓
03020171	32x5/4"	20	160 P2	1.09	✓
03020081	40x1"	15	105 P2	1.76	✓
03020091	40x5/4"	15	90 P2	1.76	✓
03020101	40x6/4"	15	90 P2	1.98	✓
03020141	50x5/4"	-	60 P2	2.29	✓
03020111	50x6/4"	-	60 P2	2.29	✓
03020151	50x2"	-	60 P2	2.29	✓
03020121	63x2"	-	35 P2	3.17	✓

## Group 03010

## PP MALE ADAPTOR



Code	Size	Bag	Box	Price €	Stock
03010191	16x1/2"	20	500 P2	0.575	✓
03010201	16x3/4"	20	400 P2	0.575	✓
03010011	20x1/2"	20	480 P2	0.587	✓
03010021	20x3/4"	20	400 P2	0.587	✓
03010031	25x1/2"	20	280 P2	0.668	✓
03010041	25x3/4"	20	280 P2	0.668	✓
03010051	25x1"	20	280 P2	0.676	✓
03010181	32x1/2"	20	200 P2	0.850	✓
03010061	32x3/4"	20	200 P2	0.850	✓
03010071	32x1"	20	160 P2	0.850	✓
03010081	32x5/4"	20	160 P2	0.960	✓
03010091	40x3/4"	20	100 P2	1.69	✓
03010101	40x1"	15	105 P2	1.69	✓
03010111	40x5/4"	15	90 P2	1.69	✓
03010121	40x6/4"	15	90 P2	1.69	✓
03010131	50x5/4"	-	64 P2	2.22	✓
03010141	50x6/4"	-	64 P2	2.22	✓
03010151	50x2"	-	62 P2	2.25	✓
03010161	63x6/4"	-	44 P2	3.15	✓
03010171	63x2"	-	44 P2	3.15	✓

## Group 03030

## PP COUPLING



Code	Size	Bag	Box	Price €	Stock
03030081	16x16	20	280 P2	0.979	✓
03030011	20x20	20	280 P2	0.998	✓
03030021	25x25	20	160 P2	1.22	✓
03030031	32x32	15	90 P2	1.55	✓
03030051	40x40	10	60 P2	2.69	✓
03030061	50x50	-	40 P2	3.62	✓
03030071	63x63	-	22 P2	5.15	✓

## Group 03040

## PP REDUCING COUPLING



Code	Size	Bag	Box	Price €	Stock
03040151	20x16	20	280 P2	1.16	✓
03040161	25x16	20	200 P2	1.19	✓
03040011	25x20	20	200 P2	1.19	✓
03040021	32x20	20	160 P2	1.54	✓
03040031	32x25	20	120 P2	1.54	✓
03040041	40x20	20	80 P2	2.66	✓
03040051	40x25	10	90 P2	2.66	✓
03040061	40x32	10	80 P2	2.66	✓
03040071	50x20	-	60 P2	3.43	✓
03040081	50x25	-	60 P2	3.43	✓
03040091	50x32	-	60 P2	3.43	✓
03040101	50x40	-	47 P2	3.43	✓
03040111	63x25	-	48 P2	4.86	✓
03040121	63x32	-	48 P2	4.86	✓
03040131	63x40	-	32 P2	4.86	✓
03040141	63x50	-	32 P2	4.86	✓

## Group 03130

## PP COUPLING WITH OR



Code	Size	Bag	Box	Price €	Stock
03130011	25x1"	20	200 P2	1.10	✓
03130021	32x1"	20	160 P2	1.24	✓

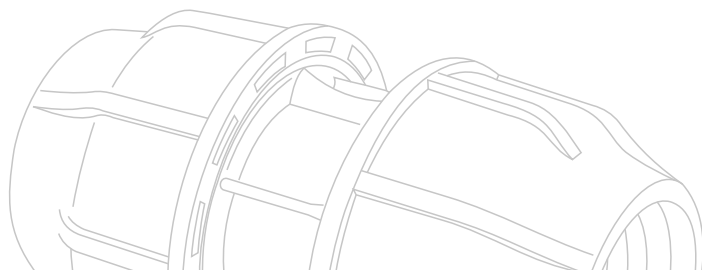

## Group 03050

## PP END PLUG



Code	Size	Bag	Box	Price €	Stock
03050071	16	20	480 P2	0.685	✓
03050011	20	20	480 P2	0.702	✓
03050021	25	20	320 P2	0.783	✓
03050031	32	20	200 P2	0.960	✓
03050041	40	20	120 P2	1.69	✓
03050051	50	-	75 P2	2.45	✓
03050061	63	-	48 P2	3.37	✓

## Group 03080

## PP FEMALE ELBOW



Code	Size	Bag	Box	Price €	Stock
03080201	16x1/2"	20	400 P2	0.787	✓
03080191	16x3/4"	20	300 P2	0.787	✓
03080011	20x1/2"	20	400 P2	0.802	✓
03080021	20x3/4"	20	300 P2	0.802	✓
03080031	25x1/2"	20	240 P2	1.01	✓
03080041	25x3/4"	20	240 P2	1.01	✓
03080051	25x1"	20	200 P2	1.01	✓
03080061	32x1/2"	20	140 P2	1.21	✓
03080071	32x3/4"	20	120 P2	1.21	✓
03080081	32x1"	20	120 P2	1.21	✓
03080171	32x5/4"	10	100 P2	1.26	✓
03080091	40x1"	10	60 P2	2.43	✓
03080101	40x5/4"	10	60 P2	2.43	✓
03080141	40x6/4"	10	60 P2	2.43	✓
03080151	50x5/4"	-	40 P2	3.27	✓
03080111	50x6/4"	-	40 P2	3.27	✓
03080161	50x2"	-	40 P2	3.27	✓
03080131	63x6/4"	-	25 P2	-	SOON
03080121	63x2"	-	25 P2	4.33	✓

## Group 03140

## PP ELBOW WITH OR



Code	Size	Bag	Box	Price €	Stock
03140011	25x1"	20	200 P2	1.40	✓
03140021	32x1"	20	120 P2	1.71	✓

## Group 03070

## PP MALE ELBOW



Code	Size	Bag	Box	Price €	Stock
03070181	16x1/2"	20	400 P2	0.704	✓
03070191	16x3/4"	20	360 P2	0.704	✓
03070011	20x1/2"	20	400 P2	0.718	✓
03070021	20x3/4"	20	360 P2	0.730	✓
03070031	25x1/2"	20	240 P2	0.884	✓
03070041	25x3/4"	20	240 P2	0.884	✓
03070051	25x1"	20	200 P2	0.884	✓
03070161	32x1/2"	20	140 P2	1.19	✓
03070061	32x3/4"	15	150 P2	1.19	✓
03070071	32x1"	20	120 P2	1.13	✓
03070171	32x5/4"	20	100 P2	1.19	✓
03070081	40x1"	10	60 P2	1.89	✓
03070091	40x5/4"	10	60 P2	1.89	✓
03070101	40x6/4"	10	60 P2	1.94	✓
03070111	50x5/4"	-	40 P2	2.58	✓
03070121	50x6/4"	-	38 P2	2.52	✓
03070131	50x2"	-	35 P2	2.67	✓
03070151	63x6/4"	-	23 P2	3.44	✓
03070141	63x2"	-	23 P2	3.44	✓

## Group 03060

## PP ELBOW COUPLING



Code	Size	Bag	Box	Price €	Stock
03060071	16x16	20	240 P2	1.01	✓
03060011	20x20	20	240 P2	1.04	✓
03060021	25x25	20	160 P2	1.27	✓
03060031	32x32	15	90 P2	1.58	✓
03060041	40x40	5	45 P2	2.88	✓
03060051	50x50	-	25 P2	3.94	✓
03060061	63x63	-	16 P2	4.99	✓

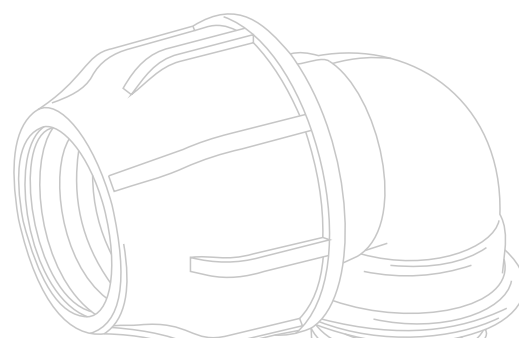

## Group 03110

## PP MALE TEE



Code	Size	Bag	Box	Price €	Stock
03110181	16x1/2"x16	20	200 P2	1.12	✓
03110191	16x3/4"x16	20	200 P2	1.12	✓
03110011	20x1/2"x20	20	200 P2	1.14	✓
03110021	20x3/4"x20	20	200 P2	1.14	✓
03110031	25x1/2"x25	20	120 P2	1.43	✓
03110041	25x3/4"x25	20	120 P2	1.43	✓
03110051	25x1"x25	20	120 P2	1.43	✓
03110161	32x1/2"x32	15	70 P2	1.88	✓
03110061	32x3/4"x32	15	75 P2	1.88	✓
03110071	32x1"x32	10	70 P2	1.88	✓
03110171	32x5/4"x32	10	60 P2	1.88	✓
03110081	40x1"x40	5	35 P2	3.25	✓
03110091	40x5/4"x40	5	35 P2	3.88	✓
03110141	40x6/4"x40	5	35 P2	3.88	✓
03110101	50x5/4"x50	-	23 P2	4.65	✓
03110111	50x6/4"x50	-	23 P2	4.65	✓
03110151	50x2"x50	-	23 P2	4.65	✓
03110131	63x6/4"x63	-	12 P2	6.85	✓
03110121	63x2"x63	-	12 P2	6.85	✓

## Group 03120

## PP FEMALE TEE



Code	Size	Bag	Box	Price €	Stock
03120181	16x1/2"x16	20	200 P2	1.14	✓
03120191	16x3/4"x16	20	160 P2	1.14	✓
03120011	20x1/2"x20	20	200 P2	1.15	✓
03120021	20x3/4"x20	20	160 P2	1.20	✓
03120031	25x1/2"x25	20	120 P2	1.43	✓
03120041	25x3/4"x25	20	120 P2	1.43	✓
03120051	25x1"x25	20	120 P2	1.54	✓
03120161	32x1/2"x32	10	70 P2	1.91	✓
03120061	32x3/4"x32	10	70 P2	1.91	✓
03120071	32x1"x32	10	70 P2	1.92	✓
03120171	32x5/4"x32	10	60 P2	1.92	✓
03120081	40x1"x40	5	40 P2	3.59	✓
03120091	40x5/4"x40	5	40 P2	3.59	✓
03120131	40x6/4"x40	5	40 P2	3.59	✓
03120141	50x5/4"x50	-	25 P2	4.75	✓
03120101	50x6/4"x50	-	25 P2	4.75	✓
03120151	50x2"x50	-	25 P2	4.75	✓
03120121	63x6/4"x63	-	14 P2	-	SOON
03120111	63x2"x63	-	14 P2	6.86	✓

## Group 03090

## PP TEE COUPLING



Code	Size	Bag	Box	Price €	Stock
03090071	16x16x16	20	160 P2	1.33	✓
03090011	20x20x20	20	160 P2	1.34	✓
03090021	25x25x25	15	90 P2	1.78	✓
03090031	32x32x32	10	50 P2	2.29	✓
03090041	40x40x40	5	30 P2	4.00	✓
03090051	50x50x50	-	18 P2	5.47	✓
03090061	63x63x63	-	10 P2	7.79	✓

## Group 03100

## PP REDUCING TEE



Code	Size	Bag	Box	Price €	Stock
03100221	20x16x20	20	160 P2	1.90	✓
03100011	25x20x25	20	120 P2	1.94	✓
03100211	25x32x25	10	80 P2	2.41	✓
03100021	32x20x32	15	60 P2	2.41	✓
03100031	32x25x32	15	60 P2	2.41	✓
03100041	40x25x40	5	35 P2	3.59	✓
03100051	40x32x40	5	30 P2	3.59	✓
03100061	50x25x50	-	20 P2	4.71	✓
03100071	50x32x50	-	20 P2	4.71	✓
03100081	50x40x50	-	20 P2	4.92	✓
03100091	63x32x63	-	12 P2	6.70	✓
03100101	63x40x63	-	12 P2	6.70	✓
03100111	63x50x63	-	12 P2	6.70	✓

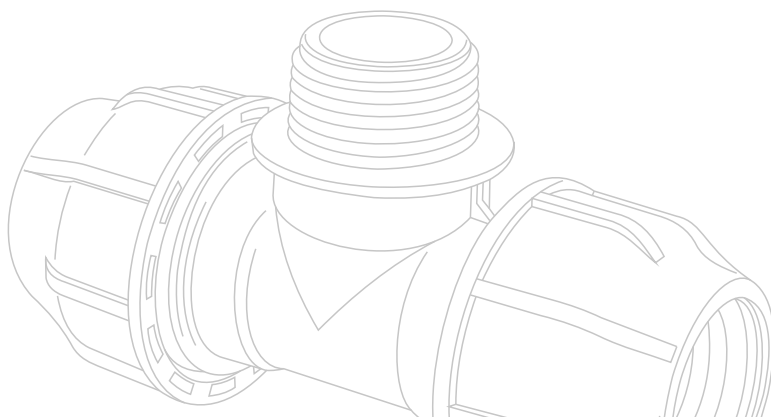

Group 03200

**NUT**



Code	Size	Bag	Box	Price €	Stock
03200180	16	-	-	On Request	✓
03200190	20	-	-	On Request	✓
03200200	25	-	-	On Request	✓
03200210	32	-	-	On Request	✓
03200220	40	-	-	On Request	✓
03200230	50	-	-	On Request	✓
03200240	63	-	-	On Request	✓

Group 03200

**THRUST RING**



Code	Size	Bag	Box	Price €	Stock
03200010	16	-	-	On Request	✓
03200020	20	-	-	On Request	✓
03200030	25	-	-	On Request	✓
03200040	32	-	-	On Request	✓
03200050	40	-	-	On Request	✓
03200060	50	-	-	On Request	✓
03200070	63	-	-	On Request	✓

Group 03200

**CLINCHING RING**



Code	Size	Bag	Box	Price €	Stock
03200100	16	-	-	On Request	✓
03200110	20	-	-	On Request	✓
03200120	25	-	-	On Request	✓
03200130	32	-	-	On Request	✓
03200140	40	-	-	On Request	✓
03200150	50	-	-	On Request	✓
03200160	63	-	-	On Request	✓

Group 03200

**O RING - GASKET**



Code	Size	Bag	Box	Price €	Stock
03200250	16	-	-	On Request	✓
03200260	20	-	-	On Request	✓
03200270	25	-	-	On Request	✓
03200280	32	-	-	On Request	✓
03200290	40	-	-	On Request	✓
03200300	50	-	-	On Request	✓
03200310	63	-	-	On Request	✓



## ASSEMBLING INSTRUCTIONS

### Assembling instruction for fittings Ø16 - Ø63 mm

①



Remove the nut and the clinching ring completely from the body of the fitting.

②



The nut and the clinching ring have to be pulled up on the pipe.

③



Insert the pipe into the fitting body and make sure the pipe crossed the O ring - gasket.

④



Pull back the clinching ring to its original position.

⑤



Pull back the nut and fully coil it up to the fitting.

⑥



Assembled fitting.

### IMPORTANT

- The end of the pipe has to be chamfered and cleaned from a chip.
- From Ø16 - Ø40 mm diameter, it is enough to coil the nut by hand.
- If the nut is not fixed completely, there can be dripping or flowing at the O ring-gasket, or the pressure can fire the pipe from the fitting.
- The threaded end of the PP fitting has to be covered with PTFE (polytetrafluoroethylene) tape or braid.
- The threaded end of PP fitting has to be coiled in completely (useful thread length).

### NOTIFICATION

- Any chemicals in the system are in contact with polypropylene (PP) and the rubber gasket (O-ring) of the PP Compression fitting.
- Appropriate tests have to be done to ensure product suitability and safety following all applicable regulations.

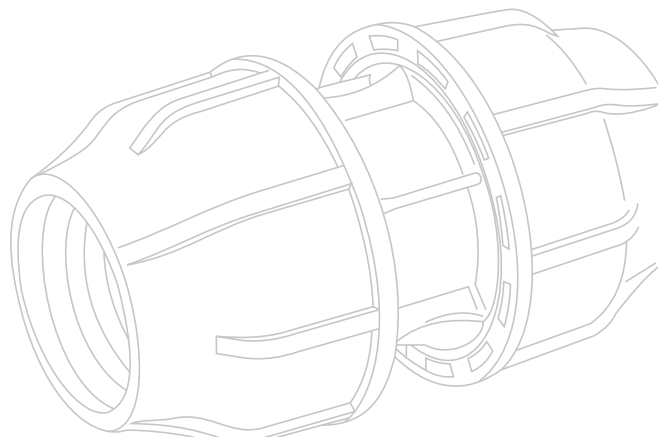



## PP Clamp Saddles

PP clamp saddles are the ideal solution for branching from existing pipelines for water and irrigation applications. Maximum operating pressure is from 6 up to 12.5 bar – depending on the diameter of clamp saddles and if clamp saddles have or do not have the reinforcing ring.

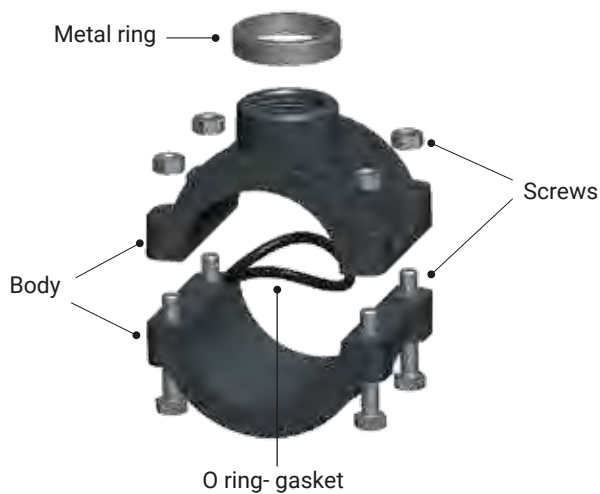

### Specifications and Technical Data

Size	20 - 315 mm
Body	Black Polypropylene (PP)
Reinforcing metal ring	Galvanized steel
Bolts (screws) and Nuts	Galvanized steel
O ring - gasket	Special elastomeric nitrile rubber (NBR)
Operating pressure	With ring: 20-63 Ø - 12.5 bar 75-315 Ø - 10 bar Without ring: 20-63 Ø - 10 bar 75-160 Ø - 6 bar
Standard	ISO 13460
Number of bolts	20 - 50 mm (2) 63 - 125 mm (4) 140 - 160 mm (6)

### Features

- Easy to install
- Can be installed on any plastic metric pipework
- Reinforced clamp saddles available
- Resistant to breakage
- Can withstand high impact
- Sturdy construction

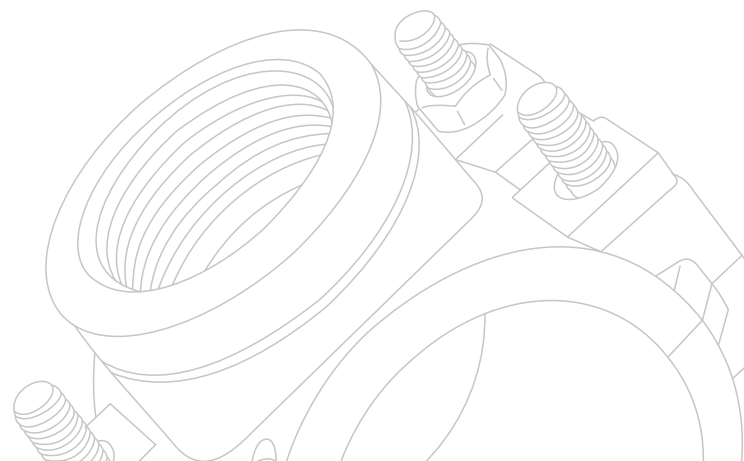



## Group 02180

**CLAMP SADDLE**

Code	Size	Box	Price €	Stock
● 02180010	20x1/2"	150 P3	0.757	✓
02180020	25x1/2"	150 P2	0.863	✓
02180030	25x3/4"	150 P2	0.863	✓
02180040	32x1/2"	150 P2	0.901	✓
02180050	32x3/4"	150 P2	0.901	✓
02180060	32x1"	150 P2	0.901	✓
02180070	40x1/2"	140 P2	1.01	✓
02180080	40x3/4"	140 P2	1.01	✓
02180090	40x1"	140 P2	1.01	✓
● 02180100	50x1/2"	100 P3	1.48	✓
● 02180110	50x3/4"	100 P3	1.48	✓
● 02180120	50x1"	100 P3	1.48	✓
● 02180130	50x5/4"	100 P3	1.48	✓
● 02180140	63x1/2"	100 P5	1.96	✓
● 02180150	63x3/4"	100 P5	1.96	✓
● 02180160	63x1"	100 P5	1.96	✓
● 02180170	63x5/4"	100 P5	1.96	✓
● 02180180	63x6/4"	100 P5	1.96	✓
● 02180190	75x1/2"	80 P5	2.51	✓
● 02180200	75x3/4"	80 P5	2.51	✓
● 02180210	75x1"	80 P5	2.51	✓
● 02180220	75x5/4"	80 P5	2.51	✓
● 02180230	75x6/4"	70 P5	2.51	✓

Code	Size	Box	Price €	Stock
● 02180240	75x2"	70 P5	2.51	✓
● 02180250	90x3/4"	60 P5	2.87	✓
● 02180260	90x1"	60 P5	2.87	✓
● 02180270	90x5/4"	60 P5	2.87	✓
● 02180280	90x6/4"	60 P5	2.87	✓
● 02180290	90x2"	55 P5	3.27	✓
● 02180300	110x1/2"	40 P5	3.43	✓
● 02180310	110x3/4"	40 P5	3.43	✓
● 02180320	110x1"	40 P5	3.43	✓
● 02180330	110x5/4"	40 P5	3.43	✓
● 02180340	110x6/4"	40 P5	3.43	✓
● 02180350	110x2"	40 P5	3.43	✓
● 02180360	110x2 1/2"	35 P5	4.02	✓
● 02180370	125x3/4"	35 P5	4.74	✓
● 02180380	125x1"	35 P5	4.74	✓
● 02180390	125x5/4"	35 P5	4.74	✓
● 02180400	125x6/4"	35 P5	4.74	✓
● 02180410	125x2"	35 P5	4.74	✓
● 02180420	125x2 1/2"	35 P5	4.74	✓
● 02180430	140x5/4"	20 P5	10.11	✓
● 02180440	160x1"	15 P5	14.25	✓
● 02180450	160x2"	18 P5	14.25	✓

## Group 02190

**CLAMP SADDLE WITH RING**

Code	Size	Box	Price €	Stock
● 02190010	63x1/2"	100 P5	3.04	✓
● 02190020	63x3/4"	100 P5	3.04	✓
● 02190040	63x1"	100 P5	3.04	✓
● 02190030	63x5/4"	100 P5	3.04	✓
● 02190050	75x1/2"	80 P5	3.88	✓
● 02190060	75x3/4"	80 P5	3.88	✓
● 02190090	75x1"	80 P5	3.88	✓
● 02190070	75x5/4"	80 P5	3.88	✓
● 02190080	75x6/4"	70 P5	3.88	✓
● 02190100	90x1/2"	60 P5	4.42	✓
● 02190130	90x1"	60 P5	4.42	✓
● 02190110	90x5/4"	60 P5	4.42	✓
● 02190120	90x6/4"	60 P5	4.42	✓
● 02190140	110x3/4"	40 P5	4.96	✓
● 02190170	110x1"	40 P5	4.96	✓
● 02190150	110x5/4"	40 P5	4.96	✓
● 02190160	110x6/4"	40 P5	4.96	✓

Code	Size	Box	Price €	Stock
● 02190180	110x2"	40 P5	4.96	✓
● 02190190	125x3/4"	35 P5	6.64	✓
● 02190220	125x1"	35 P5	6.64	✓
● 02190200	125x5/4"	35 P5	6.64	✓
● 02190210	125x6/4"	35 P5	6.64	✓
● 02190230	125x2"	35 P5	6.64	✓
● 02190260	140x1"	20 P5	12.78	✓
● 02190240	140x5/4"	20 P5	12.78	✓
● 02190250	140x6/4"	20 P5	12.78	✓
● 02190270	140x2"	20 P5	12.78	✓
● 02190280	140x3"	15 P5	16.35	✓
● 02190310	160x1"	18 P5	16.28	✓
● 02190290	160x5/4"	18 P5	16.28	✓
● 02190300	160x6/4"	18 P5	16.28	✓
● 02190320	160x2"	18 P5	16.28	✓
● 02190330	160x3"	18 P5	20.04	✓
● 02190350	160x4"	15 P5	20.04	✓





Group 02190

**CLAMP SADDLE WITH RING**

Code	Size	Box	Price €	Stock
02190380	200x1"	8 P5	56.46	✓
02190360	200x5/4"	8 P5	56.46	✓
02190370	200x6/4"	8 P5	56.46	✓
02190390	200x2"	8 P5	56.46	✓
02190400	200x3"	8 P5	57.99	✓
02190410	200x4"	8 P5	57.99	✓
02190440	225x1"	6 P5	64.33	✓
02190420	225x5/4"	6 P5	64.33	✓
02190430	225x6/4"	6 P5	64.33	✓
02190450	225x2"	6 P5	64.33	✓
02190460	225x3"	6 P5	66.73	✓
02190470	225x4"	6 P5	66.73	✓

Code	Size	Box	Price €	Stock
02190500	250x1"	4 P5	79.94	✓
02190480	250x5/4"	4 P5	79.94	✓
02190490	250x6/4"	4 P5	79.94	✓
02190510	250x2"	4 P5	79.94	✓
02190520	250x3"	4 P5	81.56	✓
02190530	250x4"	4 P5	81.56	✓
02190560	315x1"	3 P5	100.01	✓
02190540	315x5/4"	3 P5	100.01	✓
02190550	315x6/4"	3 P5	100.01	✓
02190570	315x2"	3 P5	100.01	✓
02190580	315x3"	3 P5	103.35	✓
02190590	315x4"	3 P5	103.35	✓

**ASSEMBLING INSTRUCTIONS FOR PP CLAMP SADDLES**



Place the O ring-gasket into the slot under the upper part of the clamp saddle and the steel screws into the bottom part.



Place the bottom part of the clamp saddle on the pipe. Make sure the pipe is clean.



Place the upper part of the clamp saddle on the bottom part.



Coil the steel nut up to their male parts.



Pull each screw with a wrench.



Drill the pipe through the threaded part of the clamp saddle.



Completely assembled clamp saddle.

**IMPORTANT**

- When drilling the pipe, avoid causing any damage to the thread.
- Use the largest possible size of the jobber drill.
- During the drilling, a piece of a chip can fall into the pipe, causing occlusion.
- If the screws aren't pulled completely, there can be dripping or flowing at the O-ring gasket.
- The threaded connection of fitting has to be coiled in entirely (useful thread length)
- The externally threaded part of the clamp saddle has to be covered with PTFE (polytetrafluoroethylene) tape or braid.





## Threaded fittings

Threaded fittings refer to pipe fittings connecting pipes by internal or external threads, and their dimensions are at a maximum of 4 inches in most cases. Thread connection is the oldest way that we still use today. Some of the advantages are simple usage, easy installation, the possibility of disconnection, and convenient maintenance.

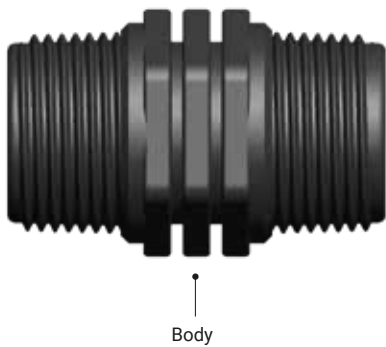

### Specifications and Technical data

<b>Size</b>	1/4" - 4"
<b>Body</b>	Black Polypropylene (PP)
<b>Operating Pressure</b>	10 bar
<b>Standards</b>	ISO 3458 ISO 7-1

### Features

- Simple usage
- Easy installation
- Able to disconnect
- Convenient maintenance

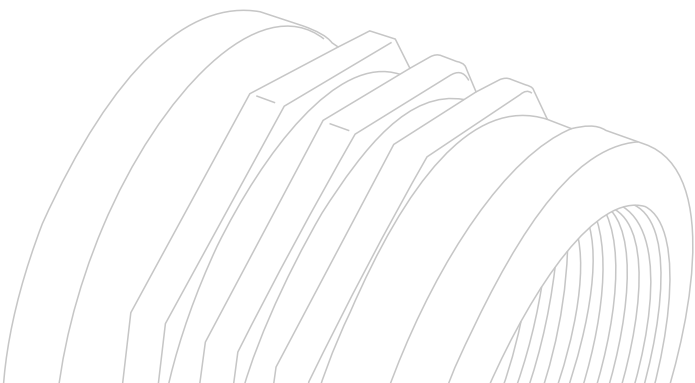

Group 06010

**NIPPLE**



Code	Size	Bag	Box	Price €	Stock
● 06010010	1/2"x1/2"	100	2500	0.124	✓
06010020	3/4"x3/4"	25	650 P2	0.171	✓
● 06010040	1"x1"	20	700	0.313	✓
● 06010050	5/4"x5/4"	10	400	0.430	✓
● 06010060	6/4"x6/4"	10	300	0.591	✓
● 06010070	2"x2"	10	180	1.34	✓
● 06010080	2 1/2"x2 1/2"	1	100	2.73	✓
● 06010090	3"x3"	1	84	3.23	✓

Group 06020

**SOCKET**



Code	Size	Bag	Box	Price €	Stock
● 06020010	1/2"x1/2"	50	1500	0.411	✓
● 06020020	3/4"x3/4"	100	800	0.411	✓
● 06020030	1"x1"	100	600	0.462	✓
● 06020040	5/4"x5/4"	10	300	1.27	✓
● 06020050	6/4"x6/4"	10	200	1.50	✓
● 06020060	2"x2"	10	120	2.27	✓
● 06020070	2 1/2"x2 1/2"	1	70	6.70	✓
● 06020080	3"x3"	1	50	7.95	✓

Group 06030

**REDUCTION FM (BUSH)**



Code	Size	Bag	Box	Price €	Stock
● 06030010	1/4"x1/2" Brass	25	25	1.66	✓
● 06030020	3/8"x1/2"	100	3500	0.298	✓
● 06030260	1/2"x3/4"	25	700	0.446	✓
● 06030040	1/2"x1"	50	1200	0.476	✓
● 06030060	1/2"x5/4"	10	650	0.806	✓
● 06030070	1/2"x 6/4"	10	500	1.40	✓
● 06030090	3/4"x1"	50	1350	0.499	✓
● 06030100	3/4"x5/4"	10	650	0.806	✓
● 06030110	3/4"x6/4"	10	500	1.40	✓
● 06030120	3/4"x2"	5	260	1.81	✓
● 06030150	1"x5/4"	10	650	0.806	✓
● 06030160	1"x6/4"	10	500	1.40	✓
● 06030170	1"x2"	5	260	1.81	✓
● 06030200	5/4"x6/4"	10	500	1.40	✓
● 06030210	5/4"x2"	5	260	1.81	✓
● 06030230	6/4"x2"	5	260	1.81	✓
● 06030250	2"x3"	1	140	3.61	✓

Group 06030

**REDUCTION FM (ENLARGING)**



Code	Size	Bag	Box	Price €	Stock
● 06030030	1/2"x3/4" (long)	25	700 P2	0.427	✓
● 06030080	3/4"x1/2"	50	900	0.615	✓
● 06030130	1"x1/2"	20	600	0.745	✓
● 06030140	1"x3/4"	20	600	0.745	✓
● 06030180	5/4"x3/4"	10	400	1.04	✓
● 06030190	5/4"x1"	10	400	1.04	✓
● 06030220	6/4"x5/4"	10	200	1.50	✓
● 06030240	2"x6/4"	5	140	2.23	✓

Group 06050

**REDUCING SOCKET**



Code	Size	Bag	Box	Price €	Stock
● 06050010	3/4"x1/2"	100	1000	0.401	✓
● 06050030	1"x3/4"	100	600	0.483	✓
● 06050040	5/4"x1"	10	300	0.975	✓
● 06050050	6/4"x5/4"	10	200	1.54	✓
● 06050060	2"x5/4"	20	140	2.16	✓
● 06050070	2"x6/4"	10	130	2.16	✓
● 06050080	2,1/2"x2"	5	80	5.68	✓
● 06050090	3"x2 1/2"	1	60	7.45	✓

Group 06040

**REDUCING NIPPLE**



Code	Size	Bag	Box	Price €	Stock
06040010	3/4"x1/2"	25	800 P2	0.171	✓
● 06040030	1"x1/2"	20	900	0.354	✓
● 06040040	1"x3/4"	50	900	0.257	✓
● 06040050	5/4"x3/4"	20	540	0.384	✓
● 06040060	5/4"x1"	20	440	0.423	✓
● 06040070	6/4"x1"	10	380	0.615	✓
● 06040080	6/4"x5/4"	10	340	0.615	✓
● 06040090	2"x6/4"	10	200	1.08	✓
● 06040100	2 1/2"x2"	5	100	2.96	✓
● 06040110	3"x2 1/2"	1	96	3.50	✓

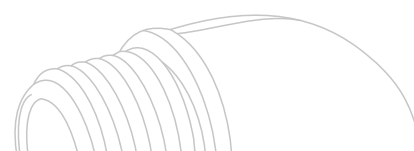

## Group 06060

**MULTI RISER**

Code	Size	Bag	Box	Price €	Stock
● 06060010	1/2"x1/2"	10	600	0.418	✓
● 06060020	1/2"x3/4"	10	500	0.418	✓
● 06060030	3/4"x 3/4"	10	450	0.418	✓

## Group 06080

**END PLUG MALE**

Code	Size	Bag	Box	Price €	Stock
● 06080010	1/2"	100	4000	0.144	✓
● 06080020	3/4"	25	800 P2	0.203	✓
● 06080040	1"	100	1300	0.257	✓
● 06080050	5/4"	100	600	0.493	✓
● 06080060	6/4"	10	550	0.719	✓
● 06080070	2"	10	300	0.873	✓

## Group 06100

**ELBOW MALE**

Code	Size	Bag	Box	Price €	Stock
● 06100010	1/2"x1/2"	100	1600	0.411	✓
06100030	3/4"x1/2"	25	700 P2	0.396	✓
06100050	3/4"x3/4"	25	600 P2	0.286	✓
06100070	1"x3/4"	25	500 P2	0.480	✓
● 06100080	1"x1"	100	500	0.401	✓
● 06100090	5/4"x5/4"	10	250	1.65	✓
● 06100100	6/4"x6/4"	10	150	2.06	✓
● 06100110	2"x2"	10	90	3.08	✓

## Group 06120

**ELBOW MF**

Code	Size	Bag	Box	Price €	Stock
● 06120010	1/2"x1/2"	20	1000	0.599	✓
● 06120020	1/2"x3/4"	100	900	0.770	✓
● 06120030	3/4"x1/2"	100	900	0.770	✓
● 06120040	3/4"x3/4"	20	540	0.770	✓
● 06120050	3/4"x1"	100	500	0.873	✓
● 06120060	1x3"/4"	100	500	0.821	✓
● 06120070	1"x1"	20	300	0.806	✓
● 06120080	5/4"x5/4"	10	200	1.73	✓

## Group 06070

**TANK ADAPTOR**

Code	Size	Bag	Box	Price €	Stock
● 06070010	1/2"	-	500	0.912	✓
● 06070020	3/4"	50	750	1.13	✓
● 06070030	1"	50	450	1.34	✓
● 06070040	6/4"	-	200	2.42	✓
● 06070050	2"	-	100	3.36	✓

## Group 06090

**END CAP FEMALE**

Code	Size	Bag	Box	Price €	Stock
● 06090010	1/2"	100	4500	0.113	✓
● 06090020	3/4"	100	2700	0.113	✓
● 06090030	1"	100	1400	0.247	✓
● 06090040	5/4"	20	600	0.630	✓
● 06090050	6/4"	10	700	0.514	✓
● 06090060	2"	10	300	0.845	✓
● 06090070	3"	5	100	4.83	✓

## Group 06110

**ELBOW FEMALE**

Code	Size	Bag	Box	Price €	Stock
● 06110010	1/2"x1/2"	20	1000	0.499	✓
● 06110020	3/4"x3/4"	20	600	0.615	✓
● 06110030	1"x1"	20	340	0.730	✓
● 06110040	5/4"x5/4"	10	200	1.35	✓
● 06110050	6/4"x6/4"	5	120	2.46	✓
● 06110060	2"x2"	2	60	3.38	✓
● 06110070	3"x3"	1	25	12.40	✓
● 06110080	4"x4"	1	16	17.27	✓

Group 06140

**TEE COUPLING MALE**



Code	Size	Bag	Box	Price €	Stock
● 06140010	1/2"x1/2"x1/2"	50	900	0.423	✓
● 06140020	1/2"x3/4"x1/2"	100	900	0.308	✓
06140040	3/4"x1/2"x3/4"	25	400 P2	0.424	✓
06140060	3/4"x3/4"x3/4"	25	400 P2	0.312	✓
06140080	3/4"x1"x3/4"	25	350 P2	0.332	✓
● 06140090	1"x1/2"x1"	100	400	0.565	✓
● 06140100	1"x3/4"x1"	100	400	0.565	✓
● 06140110	1"x1"x1"	100	400	0.514	✓
● 06140120	5/4"x5/4"x5/4"	20	240	1.27	✓
● 06140130	6/4"x6/4"x6/4"	10	150	1.50	✓
● 06140140	2"x2"x2"	1	55	3.60	✓

Group 06160

**TEE COUPLING MFM**



Code	Size	Bag	Box	Price €	Stock
● 06160020	1/2"x3/4"x1/2"	100	600	0.719	✓
● 06160030	3/4"x1/2"x3/4"	100	500	0.975	✓
● 06160040	3/4"x3/4"x3/4"	100	500	0.975	✓
● 06160050	3/4"x1x3"/4"	100	400	1.03	✓
● 06160060	1"x1/2"x1"	100	400	1.03	✓
● 06160070	1"x3/4"x1"	100	400	1.03	✓
● 06160080	1"x1"x1"	100	300	1.03	✓

Group 06150

**TEE COUPLING FEMALE**



Code	Size	Bag	Box	Price €	Stock
● 06150010	1/2"x1/2"x1/2"	20	720	0.676	✓
● 06150020	3/4"x3/4"x3/4"	10	400	0.806	✓
● 06150030	1"x1"x1"	10	240	1.04	✓
● 06150040	5/4"x5/4"x5/4"	10	130	1.77	✓
● 06150050	6/4"x6/4"x6/4"	5	90	3.04	✓
● 06150060	2"x2"x2"	2	44	4.34	✓
● 06150070	3"x3"x3"	1	16	18.58	✓
● 06150080	4"x4"x4"	1	12	26.95	✓

Group 06170

**CROSS FEMALE**



Code	Size	Bag	Box	Price €	Stock
● 06170010	3/4"	20	320	3.46	✓

Group 05300

**LAYFLAT OFFTAKE FEMALE**



Code	Size	Bag	Box	Price €	Stock
● 05300020	1/2"	100	1300	0.308	✓
● 05300030	3/4"	100	1300	0.329	✓

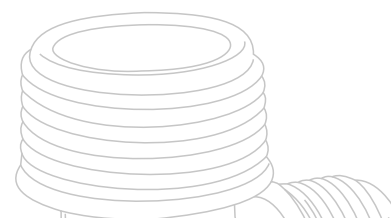

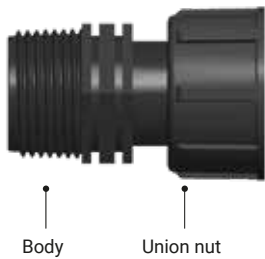

Operating pressure: 10 bar  
 Body: Black Polypropylene (PP)  
 Union Nut: Black Polypropylene (PP)  
 O-ring: NBR

Mainly used for making manifold connections for landscape and agricultural irrigation systems. Speeds up installation and simplifies maintenance of the system. Union part of Poliext Manifold fitting is fitted with a thicker O-ring to prevent leaks. Teflon is not necessary for union sealing.

The operating pressure is 10 bar.

Group 06210  
**COUPLING MF**  
 WITH O-RING



Code	Size	Bag	Box	Price €	Stock
06210100	1" x 1"	20	260 P2	1.12	✓

Group 06220  
**COUPLING FF**  
 WITH O-RING



Code	Size	Bag	Box	Price €	Stock
06220100	1" x 1"	20	200 P2	1.37	✓

Group 06230  
**ELBOW MF**  
 WITH O-RING



Code	Size	Bag	Box	Price €	Stock
06230010	1" x 1"	10	150 P2	1.32	✓

Group 06240  
**ELBOW FF**  
 WITH O-RING



Code	Size	Bag	Box	Price €	Stock
06240010	1" x 1"	10	150 P2	1.68	✓

Group 06250  
**TEE MFF**  
 WITH O-RING



Code	Size	Bag	Box	Price €	Stock
06250010	1" x 1" x 1"	10	100 P2	1.74	✓

Group 06260  
**TEE FFF**  
 WITH O-RING



Code	Size	Bag	Box	Price €	Stock
06260010	1" x 1" x 1"	10	100 P2	2.24	✓

Group 06270  
**CROSS MFFF**  
 WITH O-RING



Code	Size	Bag	Box	Price €	Stock
06270010	1" x 1" x 1" x 1"	10	80 P2	3.03	✓

Group 06280  
**CROSS FFFF**  
 WITH O-RING



Code	Size	Bag	Box	Price €	Stock
06280010	1" x 1" x 1" x 1"	10	80 P2	3.54	✓

Group 06220  
**VALVE BOX CONNECTOR FF**



Code	Size	Bag	Box	Price €	Stock
06220010	3/4" x 3/4"	10	600 P2	1.44	✓

Group 06220  
**PVC UNION**  
 WITH O-RING



Code	Size	Bag	Box	Price €	Stock
06220020	1"x1"	-	150	5.27	✓
06220030	5/4"x5/4"	-	80	6.47	✓
06220040	6/4"x6/4"	-	70	7.13	✓
06220050	2"x2"	-	48	11.51	✓





## Layflat fittings

Range of connectors for layflat hoses, variety of sizes, and types of layflat hoses available which are typically used in the agricultural irrigation sector. For connecting a steel clamp is required. Our layflat hose connectors are durable and provide high quality without leaks and spillages during transference.

### Features

- Durable
- No leaks and spillages during transference
- Range of sizes available

#### Group 18010

#### MALE ADAPTOR



Code	Size	Bag	Box	Price €	Stock
18010110	53 (2") x 2"	2	98	2.93	✓
18010120	78 (3") x 3"	3	36	4.46	✓
18010130	103 (4") x 4"	4	18	6.32	✓

#### Group 18030

#### COUPLING



Code	Size	Bag	Box	Price €	Stock
18030110	53 (2") x 53 (2")	2	78	3.90	✓
18030120	78 (3") x 78 (3")	3	38	5.51	✓
18030130	103 (4") x 103 (4")	4	15	10.32	✓

#### Group 18050

#### PLUG



Code	Size	Bag	Box	Price €	Stock
18050110	53 (2")	2	145	2.05	✓
18050120	78 (3")	3	60	3.20	✓
18050130	103 (4")	4	28	3.98	✓

#### Group 18100

#### STAINLESS STEEL STRAP



Code	Size	Bag	Box	Price €	Stock
18100110	53 (2")	2	100	2.18	✓
18100120	78 (3")	2	66	2.62	✓
18100130	103 (4")	3	44	3.25	✓

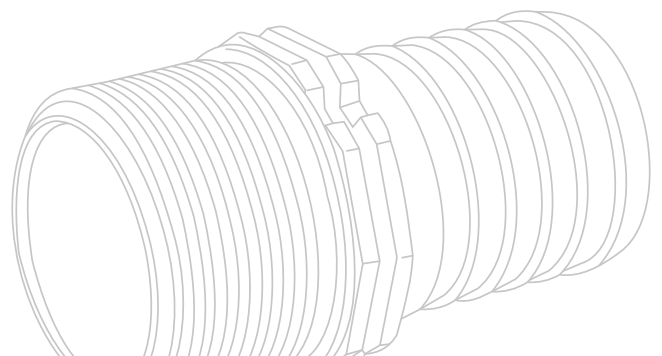



## Aluminum fittings

Used for connecting fire-fighting hoses of different diameters, to fire fittings, and to fire water sources. There are no corners or edges on the surface of the terminal that could cause an accident and cause injury. Can be connected with DIN standard terminals.

MATERIAL: Alloy cast aluminum

Group 16050

### FIRE - CLAMP THREADED



Code	Size	Price €	Stock
• 16050010	52/2"	13.54	✓
• 16050020	75 x 2 1/2"	20.43	✓
• 16050030	75 x 3"	25.53	✓

Group 16050

### FIRE - CLAMP END PLUG



Code	Size	Price €	Stock
• 16050040	52	16.18	✓

Group 16050

### FIRE - CLAMP REDUCTION



Code	Size	Price €	Stock
• 16050050	75/52	34.04	✓

Group 16050

### FIRE - CLAMP WITH CASE



Code	Size	Price €	Stock
• 16050060	52/50	12.70	✓
• 16050070	75/63	13.74	✓

Group 20040

### SEALING RING FOR FIRE - CLAMP



Code	Size	Box	Price €	Stock
• 20040080	52	50	On Request	✓
• 20040090	75	50	On Request	✓

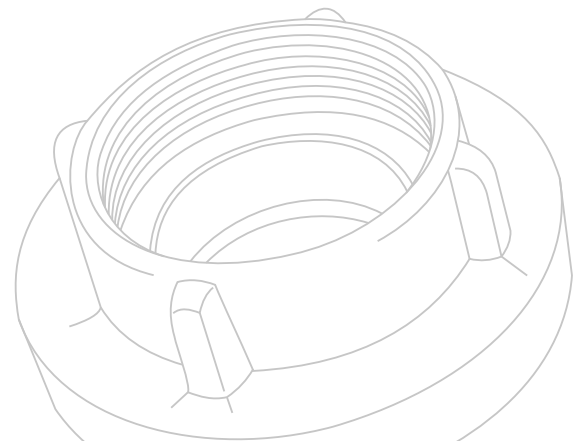

# Dripline Fittings

---

Used to join the dripline to the mainline and dripline to each other. Designed to be durable, easy to install, UV-resistant, and to assist in installation and the maintenance of the dripping system.

A wide range of applications is available, like agricultural irrigation, family garden, and greenhouses.





## Drip pipe fittings



A wide range of drip pipe fittings simplifies the installation of an irrigation system. The main advantages are the safety of connections, easy assembly, and reassembly without any tool or additional clamp.

### Features

- Secure and reliable connection
- Simple, dependable, and inexpensive
- Improve the seal and grip for the various grades of tubing
  - Pull-off resistance
  - Blow-off resistance
  - Ease of installation

### Specifications and Technical data

<b>Size</b>	Size 3.5 - 63 mm
<b>Body</b>	Black polyacetal (POM) Black polypropylene (PP)
<b>Operating pressure</b>	3 - 6 bar
<b>Types</b>	<ul style="list-style-type: none"><li>• Lock Type</li><li>• Quick Joint</li><li>• Barbed</li></ul>
<b>Standards</b>	ISO 9261 ISO 7-1

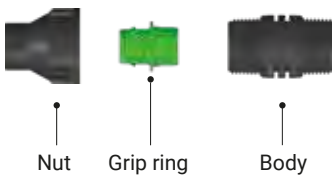

Operating pressure: 6 bar  
 Nut: Black Polypropylene (PP)  
 Grip ring: Polyacetal (POM)  
 Body: Black Polypropylene (PP)

Recommended pipe wall thickness:  
 - 16 mm: 0.8 – 1.1 mm (31 up to 44 mil)  
 - 20 mm: 0.9 – 1.4 mm (35 up to 55 mil)

Recommended for PE pipes, PoliDrip® and PoliDrip® Light

These fittings are recommended for agricultural and landscape irrigation. The redesigned cap makes it fit with the thin-wall pipes and drip tape. Ensures minimum pressure loss in the system parts where it is installed.

The operating pressure is 6 bar. Simple solution provided by wide product range.

Group 04030  
**COUPLING**



Code	Size	Bag	Box	Price €	Stock
04030030	16x16	25	300 P2	0.571	✓
04030060	20x20	25	250 P2	0.571	✓

Group 04050  
**END PLUG**



Code	Size	Bag	Box	Price €	Stock
04050030	16	25	400 P2	0.406	✓
04050060	20	25	400 P2	0.406	✓

Group 04060  
**ELBOW**



Code	Size	Bag	Box	Price €	Stock
04060030	16x16	25	250 P2	0.774	✓
04060040	20x16	25	250 P2	0.786	✓
04060070	20x20	25	250 P2	0.774	✓

Group 04110  
**FEMALE TEE**



Code	Size	Bag	Box	Price €	Stock
04110100	16x3/4"x16	50	250	1.18	✓
04110110	20x3/4"x20	50	250	1.18	✓

Group 04090  
**TEE COUPLING**



Code	Size	Bag	Box	Price €	Stock
04090030	16x16x16	25	150 P2	0.949	✓
04090080	20x20x20	25	150 P2	0.979	✓

Group 04010  
**MALE ADAPTOR**



Code	Size	Bag	Box	Price €	Stock
04010010	16x1/2"	25	400 P2	0.396	✓
04010060	16x3/4"	25	350 P2	0.369	✓
04010090	20x1/2"	25	450 P2	0.406	✓
04010130	20x3/4"	25	350 P2	0.380	✓

Group 04040  
**REDUCING COUPLING**



Code	Size	Bag	Box	Price €	Stock
04040030	20x16	25	300 P2	0.734	✓

Group 04070  
**MALE ELBOW**



Code	Size	Bag	Box	Price €	Stock
04070030	16x1/2"	25	350 P2	0.671	✓
04070060	16x3/4"	25	350 P2	0.620	✓
04070080	16x1"	25	350 P2	0.722	✓
04070120	20x1/2"	25	350 P2	0.671	✓
04070150	20x3/4"	25	300 P2	0.620	✓
04070160	20x1"	25	300 P2	0.722	✓

Group 04100  
**MALE TEE**



Code	Size	Bag	Box	Price €	Stock
04100040	16x1/2"x16	25	250 P2	0.837	✓
04100080	16x3/4"x16	25	200 P2	0.772	✓
04100050	16x1"x16	25	200 P2	0.865	✓
04100110	20x1/2"x20	25	200 P2	0.837	✓
04100150	20x3/4"x20	25	200 P2	0.772	✓
04100120	20x1"x20	25	200 P2	0.814	✓



Group 04090

**REDUCING TEE COUPLING**



Code	Size	Bag	Box	Price €	Stock
04090040	16x20x16	25	150 P2	1.340	✓
04090050	20x16x20	25	150 P2	1.235	✓

Group 04120

**OFFTAKE (14mm)**

Recommended assembling hole Ø14 mm



Code	Size	Bag	Box	Price €	Stock
04120020	16	25	400 P2	0.811	✓
04120040	20	25	400 P2	0.835	✓

Group 04200

**NUT**



Code	Size	Bag	Box	Price €	Stock
04200090	16	25	1000 P2	0.129	✓
04200120	20	25	1000 P2	0.129	✓

Group 04200

**GRIP RING**



Code	Size	Bag	Box	Price €	Stock
04200020	16	50	3500 P2	0.079	✓
04200050	20	50	2800 P2	0.079	✓

**ASSEMBLING INSTRUCTIONS FOR LOCK TYPE FITTINGS**



Separate the grip ring and nut from the body.



Pull the coupling nut up to the end of the pipe.



Push the ribbed end of the grip into the pipe.



Insert threaded part of the body on the free side of the grip ring.



Pull back the nut and coil it completely on the fitting.

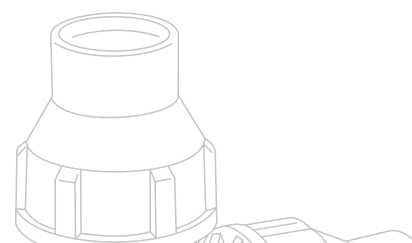

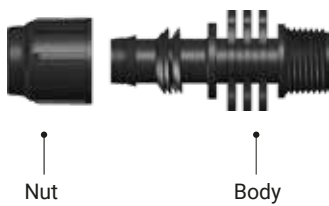

Operating pressure: 6 bar  
 Nut: Black Polypropylene (PP)  
 Body: Black Polypropylene (PP)

Recommended pipe wall thickness:  
 - 16 mm: 0.8 – 1.1 mm (31 up to 44 mil)  
 - 20 mm: 0.9 – 1.4 mm (35 up to 55 mil)

Recommended for PE pipes, PoliDrip® and PoliDrip® Light

Safe and fast way of connecting drip irrigation setup using fix grip ring. Quick joint fittings ensure additional protection even on uneven ground. They are specifically used for low-pressure connections. The maximum working pressure is 6 bar. A wide range of quick joints is available. From now on, besides 16 mm, a diameter of 20 mm is also available.

Group 04510

**MALE ADAPTOR**



Code	Size	Bag	Box	Price €	Stock
04510010	16x1/2"	25	600 P2	0.304	✓
04510020	16x3/4"	25	500 P2	0.304	✓
04510030	20x1/2"	25	400 P2	0.396	✓
04510040	20x3/4"	25	350 P2	0.396	✓

Group 04520

**FEMALE ADAPTOR**



Code	Size	Bag	Box	Price €	Stock
04520010	16x3/8"	25	500 P2	0.406	✓
04520020	16x1/2"	25	500 P2	0.406	✓
04520040	20x3/8"	25	450 P2	0.595	✓
04520050	20x1/2"	25	400 P2	0.595	✓

Group 04540

**REDUCING COUPLING**



Code	Size	Bag	Box	Price €	Stock
04540010	20x16	25	350 P2	0.633	✓

Group 04530

**COUPLING**



Code	Size	Bag	Box	Price €	Stock
04530010	16x16	25	400 P2	0.406	✓
04530020	20x20	25	250 P2	0.545	✓

Group 04560

**ELBOW**



Code	Size	Bag	Box	Price €	Stock
04560010	16x16	25	500 P2	0.556	✓
04560030	20x20	25	350 P2	0.671	✓

Group 04550

**END PLUG**



Code	Size	Bag	Box	Price €	Stock
04550010	16	25	1000 P2	0.318	✓
04550020	20	25	700 P2	0.357	✓

Group 04570

**MALE ELBOW**



Code	Size	Bag	Box	Price €	Stock
04570010	16x1/2"	25	600 P2	0.440	✓
04570020	16x3/4"	25	550 P2	0.440	✓
04570030	20x1/2"	25	450 P2	0.573	✓
04570040	20x3/4"	25	400 P2	0.573	✓

Group 04560

**REDUCING ELBOW**



Code	Size	Bag	Box	Price €	Stock
04560020	16x20	25	400 P2	0.647	✓

Group 04600

**MALE TEE**



Code	Size	Bag	Box	Price €	Stock
04600010	16x1/2"x16	25	300 P2	0.595	✓
04600020	16x3/4"x16	25	300 P2	0.620	✓
04600030	20x1/2"x20	25	250 P2	0.796	✓
04600040	20x3/4"x20	25	250 P2	0.796	✓

Group 04590

**TEE COUPLING**

Code	Size	Bag	Box	Price €	Stock
04590010	16x16x16	25	300 P2	0.747	✓
04590040	20x20x20	25	200 P2	1.02	✓

Group 04590

**REDUCING TEE COUPLING**

Code	Size	Bag	Box	Price €	Stock
04590020	16x20x16	25	250 P2	0.796	✓
04590030	20x16x20	25	200 P2	0.861	✓

Group 04620

**OFFTAKE (14 mm)**

Recommended assembling hole Ø14 mm



Code	Size	Bag	Box	Price €	Stock
04620010	16	25	400 P2	0.758	✓
04620020	20	25	350 P2	0.979	✓

Group 04400

**NUT**

Code	Size	Bag	Box	Price €	Stock
04400220	16	100	1000 P2	0.129	✓
04400250	20	100	1000 P2	0.129	✓

**ASSEMBLING INSTRUCTIONS FOR QUICK JOINTS**

- ① 

Separate the nut from the body.
- ② 

Pull the coupling nut up to the end of the tape.
- ③ 

Insert barbed part of the body on the end of the pipe.
- ④ 

Pull back the nut and coil it completely on the fitting.



Operating pressure: POM - 4 bar  
 Other - 3 bar  
 Body: POM - Polyacetal  
 Other - Black Polypropylene (PP)

Recommended pipe wall thickness:  
 - 16 mm: 0.8 – 1.1 mm (31 up to 44 mil)  
 - 20 mm: 0.9 – 1.4 mm (35 up to 55 mil)

Recommended for PoliDrip® and PoliDrip® Light

Barbed fittings are made from black POM (polyacetal) raw material to reach a sharp barb lip which makes a secure connection that is less likely to leak and slip out. Easy twist-in insertion. No need for glue or clamps for installation. A wide range of shapes and sizes allow you to choose the most suitable product for your application.

Group 05020

**BARBED COUPLING**



Code	Size	Bag	Box	Price €	Stock
05020010	3,5	500	50 000	0.028	✓
05020020	4	100	40 000	0.039	✓
05020030	5	500	30 000	0.028	✓
05020040	7	100	25 000	0.038	✓
05020050	12	100	7000	0.062	✓
05020170	16x16 POM	50	2300 P2	0.097	✓
05020070	16 with fixer	100	4200	0.108	✓
05020180	20x20 POM	50	1300 P2	0.171	✓
05020120	20 with fixer	100	2500	0.118	✓
05020140	25	100	1300	0.113	✓
05020150	32	20	740	0.207	✓
05020160	40	-	300	0.360	✓

Group 05010

**MALE ADAPTOR**



Code	Size	Bag	Box	Price €	Stock
05010170	16x1/2" POM	50	1 000 P2	0.251	✓
05010040	16x3/4" POM	50	1 000 P2	0.287	✓
05010150	20x1/2" POM	50	900 P2	0.297	✓
05010160	20x3/4" POM	50	800 P2	0.300	✓
05010070	25x1/2"	20	1 100	0.178	✓
05010080	25x3/4"	100	1 500	0.226	✓
05010090	25x1"	100	900	0.267	✓
05010100	32x3/4"	100	1 000	0.288	✓
05010110	32x1"	100	800	0.278	✓
05010120	40x1"	20	640	0.259	✓
05010130	40x5/4"	-	450	0.259	✓
05010140	63x2"	-	160	3.09	✓

Group 05040

**END PLUG**



Code	Size	Bag	Box	Price €	Stock
05040010	4	100	50 000	0.030	✓
05040020	6	100	30 000	0.036	✓
05040040	10	100	10 000	0.090	✓
05040080	16 POM	100	4000 P2	0.070	✓
05040090	20 POM	100	2400 P2	0.127	✓

Group 05030

**REDUCING COUPLING**



Code	Size	Bag	Box	Price €	Stock
05030010	7x12	100	10 000	0.057	✓
05030070	20x16 POM	50	1600 P2	0.174	✓
05030030	25x16	100	1700	0.124	✓
05030040	25x20	100	1600	0.129	✓
05030050	32x25	20	900	0.215	✓
05030060	40x32	10	450	0.237	✓

Group 05060

**ELBOW**



Code	Size	Bag	Box	Price €	Stock
05060010	12	100	5000	0.175	✓
05060090	16x16 POM	25	1600 P2	0.174	✓
05060100	20x20 POM	25	1000 P2	0.200	✓
05060060	25	100	1100	0.257	✓
05060070	32	20	540	0.777	✓
05060080	40	40	400	1.370	✓

Group 05080

**FEMALE ELBOW**



Code	Size	Bag	Box	Price €	Stock
05080010	16x3/4"	100	1200	0.770	✓



Group 05070

**MALE ELBOW**



Code	Size	Bag	Box	Price €	Stock
05070100	16x1/2" POM	25	1200 P2	0.248	✓
05070110	16x3/4" POM	25	1000 P2	0.260	✓
05070120	20x1/2" POM	25	1000 P2	0.283	✓
05070130	20x3/4" POM	25	800 P2	0.287	✓
● 05070060	25x3/4"	20	1000	0.703	✓
● 05070070	25x1"	20	700	0.703	✓
● 05070080	32x1"	20	540	0.850	✓
● 05070090	32x5/4"	-	400	0.850	✓

Group 05090

**TEE COUPLING**



Code	Size	Bag	Box	Price €	Stock
● 05090010	3.5x3.5x3.5	100	100	0.069	✓
● 05090020	4x4x4	100	20 000	0.072	✓
● 05090030	5x5x5	100	100	0.388	✓
● 05090040	12x12x12	100	3500	0.185	✓
05090130	16x16x16 POM	50	1000 P2	0.145	✓
05090140	20x20x20 POM	25	600 P2	0.208	✓
● 05090100	25x25x25	100	500	0.267	✓
● 05090110	32x32x32	20	300	0.680	✓
● 05090120	40x40x40	-	240	1.04	✓

Group 05100

**REDUCING TEE**



Code	Size	Bag	Box	Price €	Stock
05100110	16x20x16 POM	25	900 P2	0.225	✓
● 05100020	20x12x20	100	1200	0.236	✓
05100040	20x16x20 POM	25	800 P2	0.357	✓
● 05100050	20x25x20	20	840	0.703	✓
● 05100060	25x16x25	100	600	0.308	✓
● 05100080	25x20x25	100	600	0.308	✓
● 05100090	25x32x25	20	460	0.740	✓
● 05100100	32x40x32	-	250	1.30	✓

Group 05110

**MALE TEE**



Code	Size	Bag	Box	Price €	Stock
● 05110010	12x3/4x12	100	2200	0.360	✓
05110130	16x1/2x16 POM	50	1000 P2	0.203	✓
05110140	16x3/4x16 POM	50	700 P2	0.203	✓
05110150	20x1/2x20 POM	25	600 P2	0.403	✓
05110160	20x3/4x20 POM	25	500 P2	0.403	✓
● 05110060	25x1/2x25	20	500	0.740	✓
● 05110070	25x3/4x25	20	460	0.740	✓
● 05110080	25x1x25	20	460	0.740	✓
● 05110090	32x1x32	20	360	0.814	✓
● 05110100	32x5/4x32	20	300	0.814	✓
● 05110110	40x1x40	-	280	1.30	✓
● 05110120	40x5/4x40	-	250	1.30	✓

Group 05120

**FEMALE TEE**



Code	Size	Bag	Box	Price €	Stock
● 05120010	16x3/4x16	100	1000	0.667	✓
● 05120020	20x3/4x20	100	700	0.719	✓

Group 05130

**OFFTAKE (12 mm)**

Recommended assembling hole Ø12 mm



Code	Size	Bag	Box	Price €	Stock
05130110	16 POM	50	1200 P2	0.138	✓
05130120	20 POM	50	1200 P2	0.145	✓

Group 05130

**OFFTAKE (16 mm)**

Recommended assembling hole Ø16 mm



Code	Size	Bag	Box	Price €	Stock
05130410	16 POM	50	1200 P2	0.250	✓
05130420	20 POM	50	1100 P2	0.262	✓

Group 05130

**BARBED OFFTAKE (7.5 mm)**

Recommended assembling hole Ø7.5 mm



Code	Size	Bag	Box	Price €	Stock
05130310	16 POM	50	2500 P2	0.114	✗
05130320	20 POM	50	1300 P2	0.174	✗

Group 05050  
**DOUBLE RINGS**



Code	Size	Bag	Box	Price €	Stock
05050010	16	100	4000	0.057	✓
05050030	20	100	2200	0.075	✓
05050040	25	100	1300	0.139	✓

Group 05150  
**DRIPLINE CLAMP**



Code	Size	Bag	Box	Price €	Stock
05150020	20 mm	500	6000	0.180	✓

Group 06130  
**ELBOW FOR POP-UP**



Code	Size	Bag	Package	Price €	Stock
06130010	16x1/2" 6 bar	50	1250 P2	0.259	✓
06130020	16x3/4" 6 bar	50	1000 P2	0.296	✓

Group 06130  
**ELBOW FOR POP-UP (SPIRAL BARB)**



Code	Size	Bag	Package	Price €	Stock
06130050	16x1/2"	25	1600 P2	0.259	✓
06130060	16x3/4"	25	1200 P2	0.296	✓

Connection fittings for Flex Pipe

**Dripline Accessories**

Accessories used for positioning dripline on the wire or fixing it on the ground.



Supporting Hook



Ground Hook



Support Zip-tie

Find out more on page 116

**ASSEMBLING INSTRUCTIONS FOR BARBED FITTINGS**

1



Cut the pipe perpendicularly. The end of the pipe has to be straight and clean from the chip.

2



Insert the barbed part of the fitting into the pipe. Make sure that the pipe passes the last barbed ring.

3



Assembled fitting on the pipe.

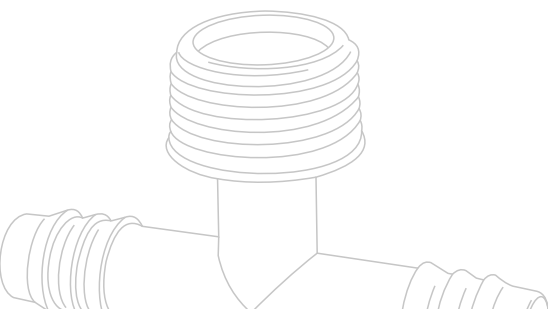



## Drip tape fittings



Drip tape fittings are specifically used for low-pressure connection of drip tapes, with a maximum operating pressure of 3 bar. A simple solution in every situation is provided by the wide product range. Available in diameters of 17 mm and 22 mm.

Ideal for use in irrigation systems both for professional and hobby users.

### Features

- Safe and fast way of connecting drip tape
- Easy handling and assembling
- Protection even on uneven ground
- Fast assembly and reassembly
- Wide product range

### Specifications and Technical data

Size	17 and 22 mm
Body	Black polypropylene (PP)
Nut	Red polypropylene (PP)
Ring	Polyacetal (POM)
Operating pressure	1- 3 bar
Types	Tape fittings Tape fittings with ring Conic tape fittings
Standards	ISO 9261 ISO 7-1

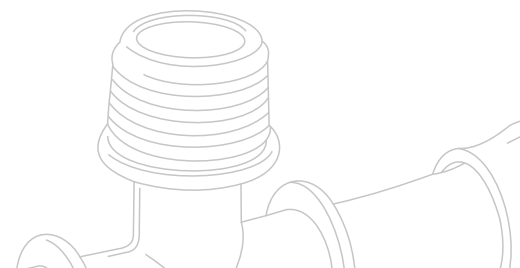

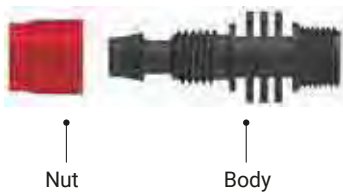

Operating pressure: 3 bar  
 Nut: Red polypropylene (PP)  
 Body: Black Polypropylene (PP)

Recommended pipe wall thickness:  
 - 17 mm: 0.15 - 0.875 mm (6 - 35 mil)  
 - 22 mm: 0.15 - 0.5 mm (6 - 20 mil)

Recommended for all types of drip tape (PoliTape® and PoliFlat®)

Tape fittings secure a safe and fast way of connecting drip tapes. The increased middle part ensures easy handling and assembling and the long grip body helps the tape to be pulled on the fitting easily. The nut gives additional pressure resistance.

Group 05310  
**MALE ADAPTOR**



Code	Size	Bag	Box	Price €	Stock
05310010	17x1/2"	25	600 P2	0.242	✓
05310040	17x1/2" (short)	25	600 P2	0.242	✓
05310060	22x1/2"	10	400 P2	-	SOON
05310020	17x3/4"	25	500 P2	0.256	✓
05310050	17x3/4" (short)	25	500 P2	0.256	✓
05310070	22x3/4"	10	400 P2	-	SOON
05310080	22x1"	10	350 P2	-	SOON

Group 05330  
**COUPLING**



Code	Size	Bag	Box	Price €	Stock
05330010	17x17	25	400 P2	0.242	✓
05330050	22x22	10	350 P2	-	SOON

Group 05340  
**END PLUG**



Code	Size	Bag	Box	Price €	Stock
05340010	17	25	1000 P2	0.180	✓
05340030	22	10	450 P2	-	SOON

Group 05350  
**ELBOW**



Code	Size	Bag	Box	Price €	Stock
05350010	17x17	25	450 P2	0.520	✓
05350030	22x22	10	400 P2	-	SOON

Group 05320  
**FEMALE ADAPTOR**



Code	Size	Bag	Box	Price €	Stock
05320010	17x3/8"	25	500 P2	0.458	✓
05320020	17x1/2"	25	450 P2	0.520	✓

Group 05330  
**QUICK ADAPTOR**



Code	Size	Bag	Box	Price €	Stock
05330220	16x17	25	400 P2	0.432	✓
05330230	20x17	25	350 P2	0.506	✓

Group 05360  
**MALE ELBOW**



Code	Size	Bag	Box	Price €	Stock
05360010	17x1/2"	25	600 P2	0.458	✓
05360011	17x1/2" (short)	25	500 P2	0.458	✗
05360060	22x1/2"	10	450 P2	-	SOON
05360020	17x3/4"	25	600 P2	0.458	✓
05360040	17x3/4" (short)	25	500 P2	0.458	✗
05360050	22x3/4"	10	450 P2	-	SOON
05360070	22x1"	10	400 P2	-	SOON

Group 05350  
**QUICK ELBOW**



Code	Size	Bag	Box	Price €	Stock
05350220	17x16	25	500 P2	0.609	✓
05350230	17x20	25	400 P2	0.659	✓

Group 05390  
**MALE TEE**



Code	Size	Bag	Box	Price €	Stock
05390010	17x1/2"x17	25	350 P2	0.747	✓
05390011	17x1/2"x17 (short)	25	400 P2	0.747	✗
05390050	22x1/2"x22	10	250 P2	-	SOON
05390020	17x3/4"x17	25	300 P2	0.747	✓
05390040	17x3/4"x17 (short)	25	300 P2	0.747	✗
05390060	22x3/4"x22	10	250 P2	-	SOON
05390070	22x1"x22	10	200 P2	-	SOON

Group 05380  
**TEE COUPLING**



Code	Size	Bag	Box	Price €	Stock
05380010	17x17x17	25	300 P2	0.609	✓
05380060	22x22x22	10	200 P2	-	SOON

Group 05380  
**QUICK TEE**



Code	Size	Bag	Box	Price €	Stock
05380020	17x16x17	25	300 P2	0.861	✓
05380230	17x20x17	25	250 P2	1.07	✓

Group 05300  
**OFFTAKE (14 mm)**

Recommended assembling hole Ø14 mm



Code	Size	Bag	Box	Price €	Stock
05300010	17	25	450 P2	0.458	✓
05300120	22	10	450 P2	-	SOON

Group 05300  
**LAYFLAT OFFTAKE**

Recommended assembling hole Ø16 mm



Code	Size	Bag	Box	Price €	Stock
05300220	17	25	450 P2	0.571	✓
05300230	22	10	400 P2	-	SOON

Group 05300  
**OFFTAKE (16 mm)**

Recommended assembling hole Ø16 mm



Code	Size	Bag	Box	Price €	Stock
05300070	17	25	450 P2	0.423	✓
05300130	22	10	450 P2	-	SOON

Group 05300  
**OFFTAKE (12 mm)**

Recommended assembling hole Ø12 mm



Code	Size	Bag	Box	Price €	Stock
05300080	17	25	600 P2	0.311	✓
05300110	22	10	450 P2	-	SOON

Group 05300  
**OFFTAKE (7.5 mm)**

Recommended assembling hole Ø7.5 mm



Code	Size	Bag	Box	Price €	Stock
05300090	17	25	600 P2	0.238	✗

**ASSEMBLING INSTRUCTIONS FOR TAPE FITTINGS**

**Offtake 14 and 16 mm**

- Drill the 14 or 16 mm hole on the chosen position in the pipe.
- Place the gasket in the hole.
- Push the offtake part of the fitting through the gasket.
- Screw the nut until you reach the pipe and tighten it by hand.

**Drip tape**

- Coil back the nut on the fitting, as much as possible.
- Pull the drip tape on the fitting. Pay attention that the nut is in its position.
- While holding the drip tape, tighten the nut with the hand. Make sure it is tighten firmly.

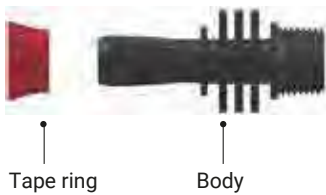

Operating pressure: 3 bar  
 Ring: Polyacetal (POM)  
 Body: Black Polypropylene (PP)

Recommended pipe wall thickness:  
 - 17mm: 0.13 - 0.3 mm (5 up to 12 mil)  
 - 22 mm: 0.15 - 0.5 mm (6 - 20 mil)

Recommended only for drip tape with flat emitters (PoliFlat®)

Tape fittings with the ring are for fast and simple connection, ideal for use in irrigation systems for connecting drip tapes. Increased middle part guarantees easy handling and assembling, and a long grip ring helps to pull the tape easily on the fitting. A simple solution for every situation is provided by a wide product range.

Group 05510

**MALE ADAPTOR WITH RING**



Code	Size	Bag	Box	Price €	Stock
05510010	17x1/2"	25	750 P2	0.229	✓
05510030	17x1/2" (short)	25	750 P2	0.229	✗
05510050	22x1/2"	10	500 P2	0.328	✓
05510020	17x3/4"	25	600 P2	0.229	✓
05510040	17x3/4" (short)	25	600 P2	0.229	✗
05510060	22x3/4"	10	450 P2	0.358	✓
05510070	22x1"	10	400 P2	0.661	✓

Group 05520

**FEMALE ADAPTOR WITH RING**



Code	Size	Bag	Box	Price €	Stock
05520010	17x3/8"	25	600 P2	0.418	✓
05520020	17x1/2"	25	600 P2	0.470	✓

Group 05530

**SHORT COUPLING WITH RING**



Code	Size	Bag	Box	Price €	Stock
05530010	17x17	25	1000 P2	0.192	✓

Group 05530

**COUPLING WITH RING**



Code	Size	Bag	Box	Price €	Stock
05530020	17x17	25	600 P2	0.229	✓
05530050	22x22	10	400 P2	0.436	✓

Group 05530

**QUICK ADAPTOR WITH RING**



Code	Size	Bag	Box	Price €	Stock
05530030	17x16	25	500 P2	0.396	✓
05530040	17x20	25	400 P2	0.458	✓

Group 05540

**END PLUG WITH RING**



Code	Size	Bag	Box	Price €	Stock
05540010	17	25	1000 P2	0.168	✓
05540020	22	10	450 P2	-	SOON

Group 05560

**MALE ELBOW WITH RING**



Code	Size	Bag	Box	Price €	Stock
05560010	17x1/2"	25	800 P2	0.440	✓
05560030	17x1/2" (short)	25	900 P2	0.440	✗
05560050	22x1/2"	10	550 P2	0.861	✓
05560020	17x3/4"	25	600 P2	0.440	✓
05560040	17x3/4" (short)	25	600 P2	0.440	✗
05560060	22x3/4"	10	550 P2	0.883	✓
05560070	22x1"	10	450 P2	0.883	✓

Group 05550

**ELBOW WITH RING**



Code	Size	Bag	Box	Price €	Stock
05550010	17x17	25	700 P2	0.470	✓
05550040	22x22	10	500 P2	1.090	✓

Group 05550

**QUICK ELBOW WITH RING**



Code	Size	Bag	Box	Price €	Stock
05550020	17x16	25	600 P2	0.556	✓
05550030	17x20	25	400 P2	0.595	✓

## Group 05590

**MALE TEE WITH RING**

Code	Size	Bag	Box	Price €	Stock
05590010	17x1/2"x17	25	500 P2	0.685	✓
05590030	17x1/2"x17 (short)	25	500 P2	0.685	✗
05590050	22x1/2"x22	10	300 P2	1.060	✓
05590020	17x3/4"x17	25	450 P2	0.696	✓
05590040	17x3/4"x17 (short)	25	450 P2	0.696	✗
05590060	22x3/4"x22	10	300 P2	1.06	✓
05590070	22x1"x22	10	210 P2	1.18	✓

## Group 05580

**TEE COUPLING WITH RING**

Code	Size	Bag	Box	Price €	Stock
05580010	17x17x17	25	400 P2	0.556	✓
05580040	22x22x22	10	250 P2	1.20	✓

## Group 05500

**OFFTAKE (14 mm) WITH RING**

Recommended assembling hole Ø14 mm



Code	Size	Bag	Box	Price €	Stock
05500010	17	25	550 P2	0.418	✓
05500080	22	25	500 P2	-	SOON

## Group 05580

**QUICK TEE WITH RING**

Code	Size	Bag	Box	Price €	Stock
05580020	17x16x17	25	350 P2	0.786	✓
05580030	17x20x17	25	300 P2	0.949	✓

## Group 05500

**OFFTAKE (16 mm) WITH RING**

Recommended assembling hole Ø16 mm



Code	Size	Bag	Box	Price €	Stock
05500030	17	25	550 P2	0.384	✓
05500090	22	10	500 P2	-	SOON

## Group 05500

**LAYFLAT OFFTAKE WITH RING**Size 17: Recommended assembling hole Ø16 mm  
Size 22: Recommended assembling hole Ø19 mm

Code	Size	Bag	Box	Price €	Stock
05500020	17	25	500 P2	0.520	✓
05500060	22	10	600 P2	1.53	✓

## Group 05500

**OFFTAKE (7.5 mm) WITH RING**

Recommended assembling hole Ø7.5 mm



Code	Size	Bag	Box	Price €	Stock
05500050	17	25	600 P2	0.225	✗

## Group 05500

**OFFTAKE (12 mm) WITH RING**

Recommended assembling hole Ø12 mm



Code	Size	Bag	Box	Price €	Stock
05500040	17	25	750 P2	0.300	✓
05500070	22	10	500 P2	-	SOON

**ASSEMBLING INSTRUCTIONS FOR TAPE FITTINGS WITH RING**

①



Pull back the ring on the fitting, as much as possible.

②



Pull the drip tape on the fitting. Pay attention that the ring is in its position.

③



While holding the drip tape, pull the ring with the hand over the tape, as much as possible. Make sure it is tightened firmly.

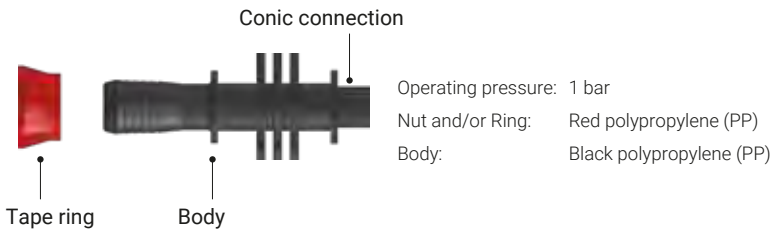

Conic tape fittings are specifically used to connect drip tapes with layflat hoses in an irrigation system. The quick and easy installation enables fast assembling and reassembling. You only have to push the body of the fitting into the base – no thread and sealing tape required. No need for a special tool or additional clamp.

Group 05710  
**OFFTAKE**



Code	Size	Bag	Box	Price €	Stock
05710010	17	25	600 P2	0.256	✓
05810010	17 with ring	25	750 P2	0.238	✓

Group 05750  
**ELBOW OFFTAKE**



Code	Size	Bag	Box	Price €	Stock
05750010	17	25	600 P2	0.472	✓
05850010	17 with ring	25	800 P2	0.432	✓

Group 05780 / 05880  
**OFFTAKE TEE**



Code	Size	Bag	Box	Price €	Stock
05780010	17	25	350 P2	0.701	✓
05880010	17 with ring	25	700 P2	0.639	✓

Group 05700  
**BASE FOR LAYFLAT (14 mm)**  
Recommended assembling hole Ø14 mm



Code	Size	Bag	Box	Price €	Stock
05700010	14	50	2200 P2	0.378	✓

**ASSEMBLING INSTRUCTIONS FOR CONIC TAPE FITTINGS**



1 Punch the 14 mm hole on the chosen position on the layflat hose.



2 Insert the base through the hole using the Allen (hex) key. Place it inside the hole and turn it until it is fully inside the pipe.

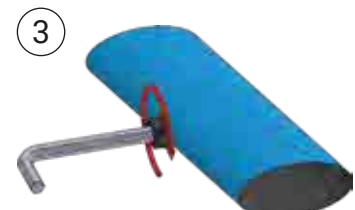

3 While holding the Allen (hex) key in place, tighten the wing nut of the base, firmly by hand.

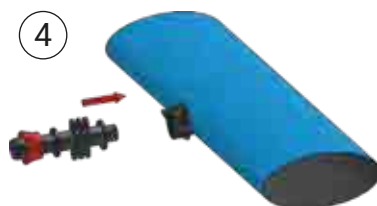

4 Push the conic part of the fitting into the base. Make sure that it is well fitted.



5 Assembled fitting on the layflat hose.

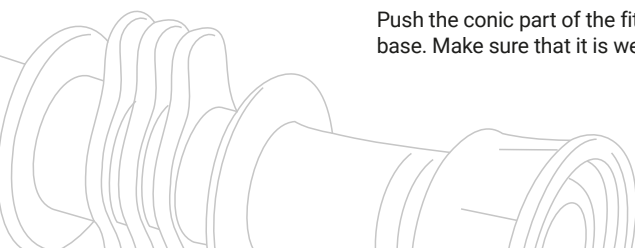

# Valves

---

Irrigation Valves are used to create various watering zones in an irrigation system. This separation allows different watering devices to be encompassed in a single system. By opening and closing a valve, each zone in your irrigation system can be watered according to the special needs of the zone.



## Low-pressure valves



Low-pressure valves are designed in various types as they regulate and control valve flow by opening, closing, or partially obstructing different passageways of the irrigation system. They enable quick and easy installation of drip lines and drip tapes.

### Features

- Safe and fast way of connecting drip irrigation setup
- Assures additional protection even on uneven ground
- Specifically used for low-pressure connection
- Special cap also makes it fit the thin-wall pipes (35 mil), standard drip lines and PE pipes
- Simple solution in every situation provided by a wide product range

### Specifications and Technical data

Body	Black Polypropylene (PP)
Nut	Black Polypropylene (PP)
Grip ring	Polyacetal (POM)
Handle	Polyacetal (POM)
Operating Pressure	Cylinder MINI valves - 2 bar Cylinder valves - 6 bar
Size	16 – 25 mm
Standards	ISO 9911 ISO 7-1

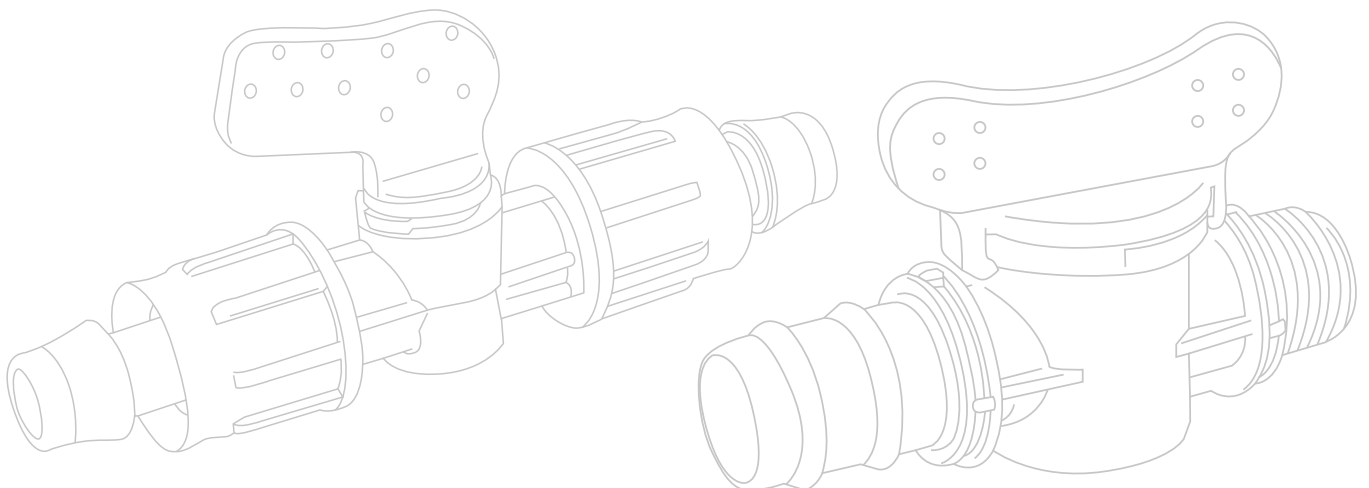





Operating Pressure: 2 bar  
 Size: 16 – 20 mm  
 Body: Black Polypropylene (PP)  
 Nut: Black Polypropylene (PP)  
 Handle: Polyacetal (POM)

Our new generation of low-pressure valves for irrigation is available with a maximum operating pressure of 2 bars. Cylinder MINI valves represent the best mix of performance and value. A diverse product range makes it ideal for various types of irrigation. Mostly, they are used in open fields and greenhouse irrigation.

Group 07300

**MALE**



Code	Size	Bag	Box	Price €	Stock
07300010	1/2"x1/2"	25	600 P2	0.506	✓
07300020	3/4"x1/2"	25	500 P2	0.506	✓
07300030	3/4"x3/4"	25	500 P2	0.506	✓

Group 07340

**OFFTAKE (14 mm) QUICK JOINT**

Recommended assembling hole Ø14 mm



Code	Size	Bag	Box	Price €	Stock
07340010	16	25	400 P2	0.850	✓

Group 07320

**QUICK JOINT**



Code	Size	Bag	Box	Price €	Stock
07320010	16x16	25	350 P2	0.647	✓

Group 07310

**QUICK JOINT / MALE**



Code	Size	Bag	Box	Price €	Stock
07310010	16x1/2"	25	400 P2	0.556	✓
07310020	16x3/4"	25	400 P2	0.556	✓

Group 07280

**BARBED**



Code	Size	Bag	Box	Price €	Stock
07280010	16x16	25	700 P2	0.498	✓
07280030	20x20	25	600 P2	0.498	✓

Group 07290

**BARBED / MALE**



Code	Size	Bag	Box	Price €	Stock
07290010	16x1/2"	25	700 P2	0.520	✓
07290020	16x3/4"	25	500 P2	0.520	✓
07290030	20x1/2"	25	500 P2	0.520	✓
07290040	20x3/4"	25	500 P2	0.520	✓

Group 07480

**OFFTAKE (14 mm) BARBED**

Recommended assembling hole Ø14 mm



Code	Size	Bag	Box	Price €	Stock
07480070	16	25	500 P2	0.620	✓
07480080	20	25	450 P2	0.620	✓

Group 07480

**OFFTAKE (12 mm) BARBED**

Recommended assembling hole Ø12 mm



Code	Size	Bag	Box	Price €	Stock
07480050	16	25	450 P2	0.521	✓
07480060	20	25	400 P2	0.521	✓

Group 07480

**OFFTAKE (7.5 mm) BARBED**

Recommended assembling hole Ø7.5 mm



Code	Size	Bag	Box	Price €	Stock
07480010	16	25	450 P2	0.498	✗
07480020	20	25	400 P2	0.498	✗

Group 07480

**OFFTAKE (16 mm) BARBED**

Recommended assembling hole Ø16 mm



Code	Size	Bag	Box	Price €	Stock
07480030	16	25	600 P2	0.609	✓
07480040	20	25	400 P2	0.609	✓

Group 07330

**OFFTAKE (14 mm) MALE**

Recommended assembling hole Ø14 mm



Code	Size	Bag	Box	Price €	Stock
07330010	1/2"	25	400 P2	0.734	✓
07330020	3/4"	25	400 P2	0.734	✓

Group 07350

**OFFTAKE (12 mm) TAPE**

Recommended assembling hole Ø12 mm



Code	Size	Bag	Box	Price €	Stock
07350030	17	25	400 P2	0.602	✓

Group 07350

**OFFTAKE (14 mm) TAPE**

Recommended assembling hole Ø14 mm



Code	Size	Bag	Box	Price €	Stock
07350010	17	25	350 P2	0.659	✓

Group 07350

**OFFTAKE (16 mm) TAPE**

Recommended assembling hole Ø16 mm



Code	Size	Bag	Box	Price €	Stock
07350020	17	25	400 P2	0.658	✓

Group 07350

**OFFTAKE (7.5 mm) TAPE**

Recommended assembling hole Ø7.5 mm



Code	Size	Bag	Box	Price €	Stock
07350040	17	25	350 P2	0.547	✗

Group 07370

**TAPE / MALE**



Code	Size	Bag	Box	Price €	Stock
07370010	17x1/2"	25	400 P2	0.556	✓
07370020	17x3/4"	25	350 P2	0.556	✓

Group 07390

**TAPE**



Code	Size	Bag	Box	Price €	Stock
07390010	17x17	25	300 P2	0.647	✓

Group 07440

**TAPE LAYFLAT OFFTAKE**

Recommended assembling hole Ø16 mm



Code	Size	Bag	Box	Price €	Stock
07440010	17	25	400 P2	0.696	✓

Group 07380

**TAPE / QUICK JOINT**



Code	Size	Bag	Box	Price €	Stock
07380010	17x16	25	300 P2	0.722	✓

Group 07410

**TAPE WITH RING / QUICK JOINT**

Recommended assembling hole Ø16 mm



Code	Size	Bag	Box	Price €	Stock
07410010	17x16	25	450 P2	0.671	✓

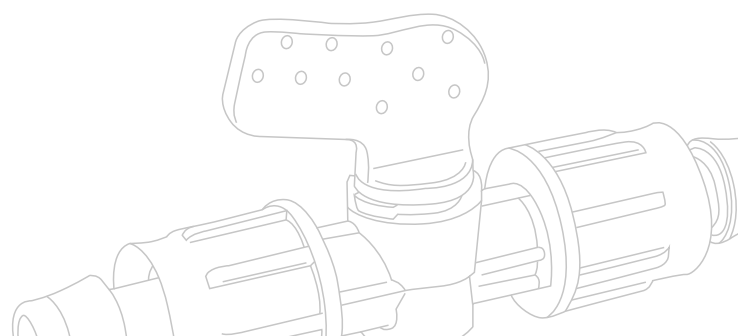

Group 07360

**OFFTAKE (12 mm)  
TAPE WITH RING**

Recommended assembling hole Ø12 mm



Code	Size	Bag	Box	Price €	Stock
07360030	17	25	500 P2	0.583	✓

Group 07360

**OFFTAKE (14 mm)  
TAPE WITH RING**

Recommended assembling hole Ø14 mm



Code	Size	Bag	Box	Price €	Stock
07360010	17	25	400 P2	0.620	✓

Group 07360

**OFFTAKE (16 mm)  
TAPE WITH RING**

Recommended assembling hole Ø16 mm



Code	Size	Bag	Box	Price €	Stock
07360020	17	25	400 P2	0.638	✓

Group 07360

**OFFTAKE (7.5 mm)  
TAPE WITH RING**

Recommended assembling hole Ø7.5 mm



Code	Size	Bag	Box	Price €	Stock
07360040	17	25	400 P2	0.547	✗

Group 07400

**TAPE RING / MALE**



Code	Size	Bag	Box	Price €	Stock
07400010	17x1/2"	25	500 P2	0.556	✓
07400020	17x3/4"	25	450 P2	0.556	✓

Group 07420

**TAPE WITH RING**



Code	Size	Bag	Box	Price €	Stock
07420010	17x17	25	500 P2	0.633	✓

Group 07450

**TAPE LAYFLAT  
OFFTAKE WITH RING**

Recommended assembling hole Ø16 mm



Code	Size	Bag	Box	Price €	Stock
07450010	17	25	450 P2	0.659	✓

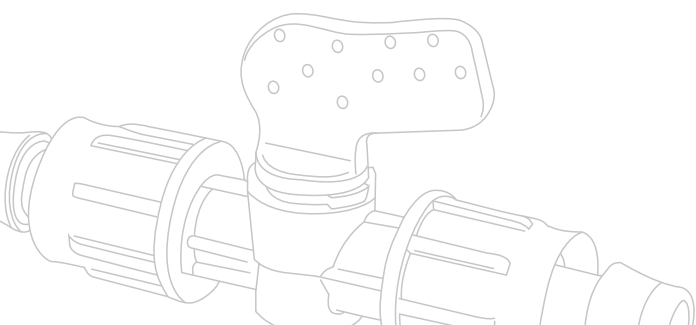

**SOON**

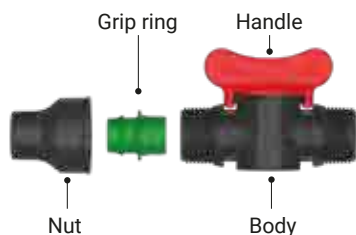

Operating pressure: 6 bar  
 Size: 16 – 25 mm  
 Body: Black Polypropylene (PP)  
 Nut: Black Polypropylene (PP)  
 Grip ring: Polyacetal (POM)  
 Handle: Polyacetal (POM)

Low-pressure valves are generally ideal for use in drip irrigation applications (gardens, greenhouses, open field irrigation). Enable setup of drip lines with minimal pressure losses. The operating pressure is max. 6 bar. The large passage hole guarantees minimal load loss in parts of the system where it is installed. The complete range from a diameter of 16 to 25 mm meets all irrigation requirements.

Group 07050  
**THREADED**



Code	Size	Bag	Box	Price €	Stock
07050065	1/2"x1/2"	25	300 P2	0.892	✓
07050055	3/4"x1/2"	25	250 P2	0.892	✓
07050045	3/4"x3/4"	25	250 P2	0.948	✓

Group 07080  
**OFFTAKE (14 mm) MALE**  
 Recommended assembling hole Ø14 mm



Code	Size	Bag	Box	Price €	Stock
07080015	1/2"	25	200 P2	1.20	✓
07080025	3/4"	25	200 P2	1.20	✓

Group 07070  
**LOCK TYPE**



Code	Size	Bag	Box	Price €	Stock
07070015	16x16	25	200 P2	1.26	✓
07070025	20x16	25	200 P2	1.29	✓
07070035	20x20	25	200 P2	1.29	✓

Group 07060  
**LOCK TYPE / MALE**



Code	Size	Bag	Box	Price €	Stock
07060075	16x1/2"	25	250 P2	1.06	✓
07060015	16x3/4"	25	250 P2	1.11	✓
07060085	20x1/2"	25	200 P2	1.06	✓
07060025	20x3/4"	25	200 P2	1.14	✓

Group 07090  
**OFFTAKE (14 mm) LOCK TYPE**  
 Recommended assembling hole Ø14 mm



Code	Size	Bag	Box	Price €	Stock
07090015	16	25	200 P2	1.43	✓
07090025	20	25	200 P2	1.44	✓

Group 07090  
**OFFTAKE (16 mm) LOCK TYPE**  
 Recommended assembling hole Ø16 mm



Code	Size	Bag	Box	Price €	Stock
07090030	16	25	200 P2	-	SOON
07090040	20	25	200 P2	-	SOON

Group 07220  
**QUICK JOINT / MALE**



Code	Size	Bag	Box	Price €	Stock
07220010	16x1/2"	25	250 P2	1.05	SOON
07220020	16x3/4"	25	250 P2	1.10	SOON
07220030	20x1/2"	25	200 P2	1.05	SOON
07220040	20x3/4"	25	200 P2	1.13	SOON

Group 07230  
**QUICK JOINT**



Code	Size	Bag	Box	Price €	Stock
07230010	16x16	25	250 P2	1.26	SOON
07230020	20x20	25	200 P2	1.29	SOON

Group 07240  
**OFFTAKE (14 mm) QUICK JOINT**  
 Recommended assembling hole Ø14 mm



Code	Size	Bag	Box	Price €	Stock
07240010	16	25	250 P2	1.43	SOON
07240020	20	25	200 P2	1.44	SOON

Group 07240  
**OFFTAKE (16 mm) QUICK JOINT**  
 Recommended assembling hole Ø16 mm



Code	Size	Bag	Box	Price €	Stock
07240030	16	25	250 P2	-	SOON
07240040	20	25	200 P2	-	SOON

Group 07180



**BARBED / MALE**

Code	Size	Bag	Box	Price €	Stock
07180165	16x1/2"	25	220 P2	0.892	✓
07180175	16x3/4"	25	220 P2	0.892	✓
07180205	20x1/2"	25	220 P2	0.892	✓
07180215	20x3/4"	25	220 P2	0.892	✓
07180225	25x1/2"	25	200 P2	0.892	✓
07180235	25x3/4"	25	200 P2	0.892	✓

Group 07170



**BARBED**

Code	Size	Bag	Box	Price €	Stock
07170085	16x16	25	250 P2	0.892	✓
07170115	20x16	25	250 P2	0.892	✓
07170135	20x20	25	220 P2	0.892	✓
07170145	25x16	25	200 P2	0.892	✓
07170165	25x20	25	200 P2	0.892	✓
07170175	25x25	25	200 P2	0.892	✓

Group 07120



**OFFTAKE (12 mm) BARBED**

Recommended assembling hole Ø12 mm

Code	Size	Bag	Box	Price €	Stock
07120050	16	25	250 P2	On Request	✓
07120060	20	25	220 P2	On Request	✓
07120070	25	25	200 P2	On Request	✓

Group 07120



**OFFTAKE (14 mm) BARBED**

Recommended assembling hole Ø14 mm

Code	Size	Bag	Box	Price €	Stock
07120015	16	25	220 P2	1.20	✓
07120035	20	25	220 P2	1.20	✓
07120045	25	25	200 P2	1.20	✓

Group 07120



**OFFTAKE (16 mm) BARBED**

Recommended assembling hole Ø16 mm

Code	Size	Bag	Box	Price €	Stock
07120080	16	25	220 P2	On Request	✓
07120090	20	25	220 P2	On Request	✓
07120100	25	25	200 P2	On Request	✓

Group 07130



**TAPE / MALE**

Code	Size	Bag	Box	Price €	Stock
07130035	17x1/2"	25	220 P2	1.06	✓
07130045	17x3/4"	25	220 P2	1.06	✓
07130050	22x3/4"	25	200 P2	On Request	✓

Group 07250



**TAPE**

Code	Size	Bag	Box	Price €	Stock
07250010	17x17	25	250 P2	On Request	✓
07250020	22x22	25	200 P2	On Request	✓

Group 07140



**TAPE / LOCK TYPE**

Code	Size	Bag	Box	Price €	Stock
07140015	16x17	25	200 P2	1.19	✓
07140025	20x17	25	200 P2	1.19	✓

Group 07190



**BARBED / TAPE**

Code	Size	Bag	Box	Price €	Stock
07190035	17x16	25	200 P2	1.06	✓
07190055	17x20	25	200 P2	1.06	✓
07190065	17x25	25	200 P2	1.06	✓

Group 07100



**OFFTAKE (12 mm) TAPE**

Recommended assembling hole Ø12 mm

Code	Size	Bag	Box	Price €	Stock
07100030	17	25	250 P2	On Request	✓
07100040	22	25	250 P2	On Request	✓

Group 07100

**OFFTAKE (14 mm) TAPE**

Recommended assembling hole Ø14 mm



Code	Size	Bag	Box	Price €	Stock
07100025	17	25	220 P2	1.20	✓
07100050	22	25	220 P2	On Request	✓

Group 07100

**OFFTAKE (16 mm) TAPE**

Recommended assembling hole Ø16 mm



Code	Size	Bag	Box	Price €	Stock
07100060	17	25	200 P2	On Request	✓
07100070	22	25	200 P2	On Request	✓

Group 07150

**TAPE WITH RING / MALE**



Code	Size	Bag	Box	Price €	Stock
07150015	17x1/2"	25	300 P2	0.979	✓
07150025	17x3/4"	25	300 P2	0.979	✓
07150030	22x3/4"	25	250 P2	On Request	✓

Group 07160

**TAPE WITH RING**



Code	Size	Bag	Box	Price €	Stock
07160030	17x17	25	300 P2	On Request	✓
07160040	22x22	25	200 P2	On Request	✓

Group 07160

**TAPE WITH RING / LOCK TYPE**



Code	Size	Bag	Box	Price €	Stock
07160010	17x16	25	250 P3	On Request	✓
07160020	17x20	25	250 P3	On Request	✓

Group 07200

**BARBED / TAPE WITH RING**



Code	Size	Bag	Box	Price €	Stock
07200015	17x16	25	300 P2	0.979	✓
07200035	17x20	25	250 P2	0.979	✓
07200045	17x25	25	250 P2	0.979	✓

Group 07110

**OFFTAKE (12 mm) TAPE WITH RING**

Recommended assembling hole Ø12 mm



Code	Size	Bag	Box	Price €	Stock
07110020	17	25	250 P2	On Request	✓
07110030	22	25	250 P2	On Request	✓

Group 07110

**OFFTAKE (14 mm) TAPE WITH RING**

Recommended assembling hole Ø14 mm



Code	Size	Bag	Box	Price €	Stock
07110015	17	25	250 P2	1.20	✓
07110040	22	25	250 P2	On Request	✓

Group 07110

**OFFTAKE (16 mm) TAPE WITH RING**

Recommended assembling hole Ø16 mm



Code	Size	Bag	Box	Price €	Stock
07110050	17	25	250 P2	On Request	✓
07110060	22	25	250 P2	On Request	✓

**Layflat hose connection**

Use any Cylinder valve with Male thread combined with Layflat Offtake Female



Find out more on page 38



## High pressure valves

High-Pressure valves are used for compression or/and threaded connection which corresponds to the requirements of a water supply system (potable water and irrigation) and pressures typical in these applications. High-Pressure valves are available in various tubing sizes and body designs to satisfy widely varied requirements.

### Features

- Secure and fast connection to the water network
- Suitable for both above-ground and underground use
- Operating pressure 10 bar, PP Stop valve operating pressure 16 bar
- Easy solution thanks to the wide product range

### Specifications and Technical data

Body	Black polypropylene (PP)
Handle	Black or blue polypropylene (PP)
Design	ISO 17885
Size	ISO 3126
Threads	ISO 7-1
Pressure resistance	ISO 9911
<b>In the case of spray-bonded versions:</b>	
Nut	Blue polypropylene (PP)
Clinching ring	Polyacetal (POM)
O-ring	Ethylene propylene diene elastomer
Body	Black polypropylene (PP)
Markings	ISO 17885
Pull-out resistance	ISO 3501

## PP Compression valves PN10

The ball valve connects with the "compression joint method" from compression fittings to reduce the number of connections, combining reliable operation with easy assembling. These valves are valid to be used to conduct water and nutrition fluids. PP Compression ball valves are available in diameter from 20 up to 63 mm. The operating pressure is 10 bar at 20°C (water) engraved on the product.

### Group 07013

#### COMPRESSION VALVE

Operating pressure: 10 bar



Code	Size	Bag	Box	Price €	Stock
07013010	20x20	10	100 P2	7.73	✓
07013020	25x25	5	35 P2	9.66	✓
07013030	32x32	5	35 P2	10.94	✓
07013040	40x40	5	15 P2	16.08	✓
07013050	50x50	5	10 P2	17.36	✓
07013060	63x63	-	10 P2	26.99	✓

### Group 07015

#### COMPRESSION VALVE MALE

Operating pressure: 10 bar



Code	Size	Bag	Box	Price €	Stock
07015010	20x1/2"	10	150 P2	4.90	✓
07015020	20x3/4"	10	150 P2	6.45	✓
07015030	25x3/4"	5	50 P2	6.45	✓
07015040	32x1"	5	50 P2	7.08	✓
07015050	40x5/4"	5	15 P2	12.87	✓
07015060	50x6/4"	5	15 P2	14.79	✓
07015070	63x2"	-	10 P2	21.86	✓

### Group 07017

#### COMPRESSION VALVE FEMALE

Operating pressure: 10 bar



Code	Size	Bag	Box	Price €	Stock
07017010	20x1/2"	10	150 P2	4.90	✓
07017020	20x3/4"	10	150 P2	6.45	✓
07017030	25x3/4"	5	50 P2	6.45	✓
07017040	32x1"	5	50 P2	7.08	✓
07017050	40x5/4"	5	15 P2	12.87	✓
07017060	50x6/4"	5	15 P2	14.79	✓
07017070	63x2"	-	10 P2	21.86	✓

## PP Stop valve PN16

The plastic (Polypropylene - PP) valve connects with the "compression joint method" on both valve sides, with a maximum operating pressure of 16 bar. It is produced from high-quality UV-resistant raw material. Characterized by easy assembling, which speeds up the installation. It has a wide range of applications, used in potable-water systems and irrigation systems, both agricultural and landscape irrigation. Typical advantages of the plastic body are providing resistance against mechanical stress, corrosion, and limescale deposition.

### Group 07010

#### PP STOP VALVE

Operating pressure: 16 bar



Code	Size	Bag	Box	Price €	Stock
07010010	20x20	10	60 P2	5.98	✓
07010020	25x25	10	40 P2	6.37	✓
07010030	32x32	10	50 P2	6.90	✓

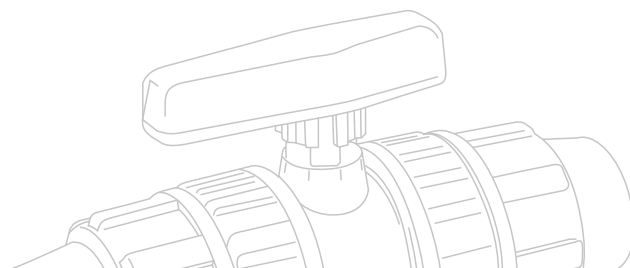



## Ball valves

A ball valve is a mechanical device that directs, guides, and modulates water flow by opening or closing a ball that is open in the middle of the valve. Turning the handle on the ball valve, it manually opens/closes the port which controls the pressure of the water flow. Durability and perfect closure are what make the ball valve more favorable compared to other types of valves.

### Group 07020

#### BALL VALVE MF (IRRIGATION)

Operating pressure: 6 bar



Code	Size	Bag	Box	Price €	Stock
07020010	3/4"x3/4"	-	100	1.66	✓
07020020	1"x1"	-	100	2.03	✓
07020030	5/4"x5/4"	-	100	3.69	✓
07020040	6/4"x6/4"	-	60	7.23	✓
07020050	2"x2"	-	30	9.03	✓
07020060	2 1/2"x2 1/2"	-	20	21.65	✓
07020070	3"x3"	-	12	29.09	✓

### Group 07030

#### BALL VALVE FF (IRRIGATION)

Operating pressure: 6 bar



Code	Size	Bag	Box	Price €	Stock
07030010	3/4"x3/4"	-	100	1.66	✓
07030020	1"x1"	-	100	2.03	✓
07030030	5/4"x5/4"	-	50	3.69	✓
07030040	6/4"x6/4"	-	32	7.23	✓
07030050	2"x2"	-	15	8.884	✓
07030060	2 1/2"x2 1/2"	-	12	21.65	✓

### Group 07040

#### BALL VALVE WITH IRON BALL

Operating pressure: 16 bar



Code	Size	Bag	Box	Price €	Stock
07040010	1/2"x1/2"	-	80	5.46	✓
07040020	3/4"x3/4"	-	40	6.69	✓
07040030	1"x1"	-	30	9.56	✓
07040040	5/4"x5/4"	-	20	15.92	✓
07040050	6/4"x6/4"	-	8	23.86	✓
07040060	2"x2"	-	7	34.69	✓
07040070	2 1/2"x2 1/2"	-	5	77.95	✓
07040080	3"x3"	-	3	97.862	✓
07040090	4"x4"	-	2	168.63	✓

### Group 07600

#### SPARE PARTS FOR BALL VALVES



Code	Description	Box	Price €	Stock
07600010	Handle for PP Stop valve	-	On Request	✓
07600020	Valve hexagonal slider	-	On Request	✓
07600030	Valve spindle	-	On Request	✓
07600040	Ball for ball valve	100	On Request	✓
07600050	O - ring 24.2x3x5	-	On Request	✓
07600060	O - ring 12x2.5	-	On Request	✓
07600070	O - ring 16x1.5	-	On Request	✓
07600080	O - ring 20x2.0	-	On Request	✓
07600090	Handle for ball valve	100	On Request	✓
07600100	Teflon ring for ball valve	100	On Request	✓
07600110	Small O - ring for ball valve	100	On Request	✓
07600120	Large O - ring for ball valve	100	On Request	✓

## Garden valve PN16

The body is molded from high-impact strength plastic (PP). It is UV, and low-temperature resistant. The inside ball and stem are made of brass. The Garden valve is available with a lever handle or a butterfly handle; the measures of the male thread connection are 1/2", 3/4", and 1". On outlet can be connected metal adaptor or garden quick-release.

### Group 07530

#### GARDEN VALVE

Operating pressure: 16 bar



Code	Size	Bag	Box	Price €	Stock
07530010	M 1/2"x3/4"	-	45	7.82	✓
07530020	M 3/4"x3/4"	-	45	10.10	✓
07530030	M 1"x1"	-	25	14.22	✓

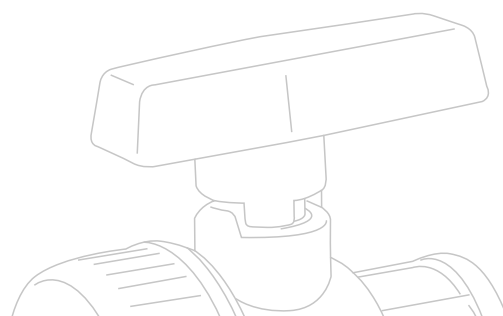

**Pressure regulators**

Pressure regulators reduce incoming water pressure to set usable pressure for the drip system. The pressure regulator is used when the incoming pressure is too high for the emitters or fittings. The flow rate of the regulator should be matched with the system. Pressure regulation does not take effect until the minimum specified flow passes through the regulator.

Group 11010

**PRESSURE REGULATOR**



Code	Size	Bag	Box	Price €	Stock
11010010	3/4" White 0.8-2.5 bar	-	50	22.24	✓
11010020	3/4" Black 3.5-6 bar	-	50	16.94	✓
11010040	1" Brown 1.5-3.5 bar	-	33	58.953	✓
11010050	1" White 0.5-1.2 bar	-	50	58.953	✓
11010060	1" Red 1-2 bar	-	50	58.953	✓
11010090	6/4" Black 1.5-3.5	-	20	148.72	✓
11010100	6/4" Red 1-2 bar	-	20	197.48	✓

Group 11010

**IN-LINE PRESSURE REGULATOR**



Code	Size	Bag	Box	Price €	Stock
11010160	1.0 bar MF 3/4"	20	500	6.42	✓
11010170	1.8 bar MF 3/4"	20	500	6.42	✓

Group 08070

**Y-FILTER WITH PRESSURE REGULATOR**



Code	Size	Bag	Box	Price €	Stock
08070010	1.0 bar 3/4"	-	60	26.66	✓
08070020	1.8 bar 3/4"	-	60	26.66	✓

**Check valves**

Suitable for domestic water services, heating, air-conditioning, and compressed air systems. They can be installed in any position (vertical, horizontal, oblique). The body is made from brass, the plate is from a polymer or stainless steel, the seal is NBR, and the spring is stainless steel. There are two types to offer, York (Plate made from polymer) and Europe (Plate made from stainless steel).

Group 11040

**CHECK VALVES YORK  
PLATE IN POLYMER**



Code	Size	Bag	Box	Price €	Stock
11040150	3/4"	-	8	9.26	✓
11040030	1"	-	8	11.88	✓
11040050	5/4"	-	6	16.176	✓
11040070	6/4"	-	4	23.646	✓
11040090	2"	-	2	32.931	✓
11040100	2 1/2"	-	2	60.782	✓
11040110	3"	-	1	85.743	✓
11040130	4"	-	1	151.80	✓

Group 11040

**CHECK VALVES EUROPA  
PLATE IN STAINLESS STEEL**



Code	Size	Bag	Box	Price €	Stock
11040160	3/4"	-	8	11.393	✓
11040040	1"	-	6	16.74	✓
11040060	5/4"	-	4	26.53	✓
11040080	2"	-	2	54.54	✓
11040120	3"	-	1	189.53	✓
11040140	4"	-	1	291.45	✓

Group 11050

**CHECK VALVE FILTERS**



Code	Size	Bag	Box	Price €	Stock
11050070	3/4"	-	20	1.461	✓
11050010	1"	-	20	1.79	✓
11050020	5/4"	-	10	2.19	✓
11050030	6/4"	-	5	2.84	✓
11050040	2"	-	5	3.92	✓
11050050	2 1/2"	-	5	6.99	✓
11050060	3"	-	5	9.15	✓

## Other valves

Different types of valves are also available: quick coupling valves, air release valves, drain valves, plastic vacuum breakers, etc. Each of these types has various features and functional capabilities, and some of them are available in different sizes.



### Quick coupling valve

The quick coupling valve is a quick and ground-level water plug, reliable and practical for irrigation and gardening. The material is resistant to weather impacts and mechanical stress. Easy assembling: Open the cover, push the key into the quick coupling valve till the hook snaps in place at the body valve and water delivery starts without leaks and wastes. To remove the key, squeeze the upper part of the hook, so the key will be released and the water delivery stops without spillages.

Group 07520

#### QUICK COUPLING VALVE

Operating pressure: 8 bar



Code	Size	Bag	Box	Price €	Stock
07520010	F 3/4"	-	60	4.98	✓
07520020	F 1"	-	60	4.98	✓

Group 07510

#### QUICK COUPLING VALVE KEY

Operating pressure: 8 bar



Code	Size	Bag	Box	Price €	Stock
07510010	M 3/4"	-	120	2.71	✓

### Air releasing valve

Air Release Valves' function is to release air pockets that collect at each high point of a full pressured pipeline. An air release valve can open against internal pressure because the internal lever mechanism multiplies the float force to be greater than the internal pressure.

Group 11060

#### AIR RELEASING VALVE



Code	Size	Bag	Box	Price €	Stock
11060020	1"	-	30	12.55	✓
11060030	2"	-	14	54.18	✓

### Drain valve

Plastic Automatic Drain Valves protect the irrigation system from damage due to freezing by automatically draining the lines when the water is turned off. Install the drain valve at the lowest point of each watering zone.

Group 11090

#### DRAIN VALVE



Code	Size	Bag	Box	Price €	Stock
11090010	3/4"	-	25	8.27	✓

## Plastic vacuum breaker

Manufactured from high-quality raw material. The plastic vacuum breaker offers outstanding features and advantages. It has perfect sealing under considerably low system pressure and high flow capacity. The patented operation, smart design, simplicity, and compactness, shape a highly reliable product. Designed to break the vacuum when the pipe drops below atmospheric conditions. On the subsurface, drip irrigation systems prevent dirt to enter the emitters.



Group 11060

### VACUUM BREAKER

Code	Size	Bag	Box	Price €	Stock
11060050	1/2"	-	100	6.29	✓

## Fertilizing equipment

In our product range, you can find various fertilizing equipment such as Fertilizing Mixer, Venturi injector, and Liquid injector.



Group 11070

### VENTURI INJECTOR

Code	Size	Bag	Box	Price €	Stock
11070020	3/4"	-	36	45.49	✓
11070050	1"	-	36	75.34	✓
11070070	5/4"	-	10	96.66	✓

## Metallic valves

Gate valves are widely used for all types of applications and are suitable for both above-ground and underground installation. Gate valves are often used if minimum pressure loss and a free bore are needed. In the fully open condition, a typical gate valve has no obstruction in the flow path resulting in a very low-pressure loss.



Group 07500

### METALLIC GATE VALVE FF

Operating pressure: 16 bar

Code	Size	Bag	Box	Price €	Stock
07500010	1"x1"	-	20	15.20	✓
07500020	5/4"x5/4"	-	10	23.59	✓
07500030	6/4"x6/4"	-	10	31.37	✓
07500040	2"x2"	-	2	44.57	✓
07500050	2 1/2"x2 1/2"	-	5	90.53	✓
07500060	3"x3"	-	4	103.35	✓
07500070	4"x4"	-	4	185.17	✓

## Bermad Electric Control Valve

Plastic Hydraulic or Electric Control Valves are suitable for residential, commercial, and agricultural irrigation systems. Bermad 200 Series plastic control valves are globe pattern (3/4" - 2") or angle pattern (1 1/2" - 2"). These control valves provide superior hydraulic performance, featuring state-of-the-art hydraulics and plastics technology.

### Group 12030

#### ELECTRIC CONTROL VALVES



Code	Size	Bag	Box	Price €	Stock
● 12030010	3/4"	-	40	30.79	✓
● 12030030	1"	-	20 P1	35.37	✓
● 12030120	6/4"	-	24	64.96	✓
● 12030190	6/4" Normally open	-	6	83.49	✓
● 12030150	2"	-	20	74.11	✓
● 12030180	3"	-	2	227.54	✓

### Group 12030

#### SOLENOID FOR ELECTRIC CONTROL VALVES



Code	Type	Bag	Box	Price €	Stock
● 12030250	24V/AC ●	1	50	22.37	✓
● 12030240	24V/DC ●	1	50	22.16	✓
● 12030260	9V/DC ●	1	50	42.74	✓

# Filters

---

Water filtration is crucial to almost every irrigation system, both agricultural and landscape irrigation. Appropriate filtration can help extend the lifetime and makes maintenance easier for any irrigation system. For drip or micro-sprinkler emitters, filtration is an essential requirement to avoid clogging.





## Plastic Filters

The plastic filters are used for filtration in the irrigation system, effectively eliminating sediment and microorganisms. They can be used alone or for secondary filtration.

We offer screen filters, disc filters, and sand media filters.

### Screen filters

A screen filter is used for water filtration using a screen to separate sand and other fine particles out of water during irrigation. They have high-quality resistance to the most common chemicals. Constructed of UV - a resistant and durable plastic material that withstands the most adverse circumstances. The screen filter cartridge can easily be removed from the filter to be cleaned, making maintenance more manageable.

#### Group 08010

#### SCREEN IN-LINE FILTER



Code	Size	m <sup>3</sup> /h	Mesh (mic)	Box	Price €	Stock
08010100	3/4"	5	120 (130)	200	5.23	✓

#### Group 08010

#### SCREEN FILTER



Code	Size	m <sup>3</sup> /h	Mesh (mic)	Box	Price €	Stock
08010010	Small 3/4"	5	120 (130)	80	3.90	✓
08010020	Large 3/4"	5	120 (130)	60	4.72	✓
08010040	Large 1"	6.5	120 (130)	60	4.31	✓
08010050	Small 1"	6	120 (130)	80	3.39	✓
08010060	Special 5/4"	8	120 (130)	35	5.85	✓
08010070	6/4"	14	120 (130)	17	10.78	✓
08010080	2"	25	120 (130)	11	16.94	✓
08010090	3"	48	120 (130)	2	148.79	✓

#### Group 08020

#### SCREEN FILTER WITH VALVE IN-LINE SPECIAL



Code	Size	m <sup>3</sup> /h	Mesh (mic)	Box	Price €	Stock
08020020	Special 1"	8	120 (130)	30	7.44	✓
08020040	Special 5/4"	8	120 (130)	30	7.44	✓

#### Group 08020

#### SCREEN FILTER WITH VALVE IN-LINE HYDROCYCLONIC



Code	Size	m <sup>3</sup> /h	Mesh (mic)	Box	Price €	Stock
08020060	6/4"	10	120 (130)	15	13.86	✓
08020080	2"	25	120 (130)	9	19.50	✓

#### Group 08100

#### SCREEN FILTER CARTRIDGE



Code	Size	Mesh (mic)	Bag	Box	Price €	Stock
08100010	Small	120 (130)	10	250	2.06	✓
08100020	Large	120 (130)	10	170	3.08	✓
08100030	Special	120 (130)	10	140	2.98	✓
08100040	1.1/2"	120 (130)	10	60	4.93	✓
08100050	2"	120 (130)	5	50	7.70	✓
08100060	3"	120 (130)	-	5	30.71	✓
08100090	Large	150 (80)	10	170	3.08	✓
08100070	Special	150 (80)	10	140	3.49	✓
08100080	2"	150 (80)	5	50	8.21	✓

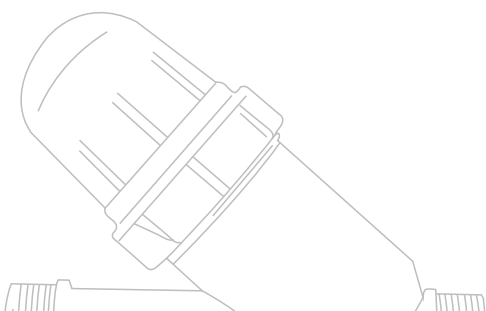

## Disc filters

The main application of the Disc filter is fine water filtration in irrigation systems. Some of the advantages of Disc filters are three-dimensional filtration, therefore the interval between cleaning is longer, resistance to common agricultural chemical fertilizers, and flushing agents used in the system. Disc filters can partially separate algae developed in the irrigation system.

### Group 08030

#### DISC FILTER



Code	Size	m³/h	Mesh (mic)	Box	Price €	Stock
08030010	Small 3/4"	5	120 (130)	60	8.52	✓
08030020	Small 1"	5	120 (130)	60	6.98	✓
08030030	Large 1"	6	120 (130)	60	8.52	✓
08030040	Special 5/4"	7.5	120 (130)	35	28.74	✓

### Group 08040

#### DISC FILTER WITH HYDROCYCLONE



Code	Size	m³/h	Mesh (mic)	Box	Price €	Stock
08040010	2"	30	120 (130)	1	146.72	✓
08040020	Typhoon 2"	30	120 (130)	1 J	148.79	✓
08040030	3"	50	120 (130)	1	146.72	✓
08040040	Typhoon 3"	50	120 (130)	1 J	210.35	✓

### Group 08100

#### DISC FILTER CARTRIDGE



Code	Size	Mesh (mic)	Bag	Box	Price €	Stock
08100150	Typhoon 2"	120 (130)	-	1	49.26	✓
08100160	Typhoon 3"	120 (130)	-	1	90.30	✓
08100170	Small	120 (130)	10	120	5.65	✓
08100180	Large	120 (130)	10	70	7.19	✓
08100190	Special	120 (130)	10	10	20.99	✓
08100210	3"	120 (130)	-	1	70.96	✓

### Group 08110

#### DISC FILTER SPARE PARTS



Code	Description	Size	Bag	Box	Price €	Stock
08110020	PP Nut	2" - 3"	-	1	On Request	✓

## Hydrocyclones

Also known as sand separators, the main use of centrifugal filters is the removal of particles such as sand, and other solids from the irrigation water, in other words, it prevents sand from entering the irrigation system. Using hydrocyclones, parts of dirt with a high specific gravity can be filtered out quite effectively. The liquid is admitted tangentially, which results in a centrifugal flow forcing the dirt parts towards the outer side of the filter.

### Group 08050

#### HYDROCYCLONE - PLASTIC



Code	Size	m³/h	Box	Price €	Stock
08050020	1"	6	1	65.39	✓
08050050	2"	30	1	199.42	✓
08050080	3"	50	1	355.34	✓





## Metal Filters

Obstruction of sprinklers and drippers is one of the most significant problems encountered in irrigation systems. Filtration is the best protection method against avoiding entrance/obstruction of a dripper, sprinkler, hydrant, and other similar equipment used in the irrigation system by sediments.

Therefore, filtration is the most significant control unit of an irrigation system.

### Autoflush® Automatic Plastic Disc Filters

AutoFlush® Automatic Plastic Disc Filter is constructed by assembling many tiny synthetic discs manufactured from polypropylene material on a filter body with a telescopic structure. When synthetic discs are arranged one on another and are centralized around within a telescopic filter body, the center of discs forms a hollow disc. They are designed to perform a deep filtration based on desired micron level found on both sides of synthetic discs and inter-sectioning of channels designed in a crosswise manner. The most outstanding advantage of AutoFlush® Automatic Plastic Disc filter is that it automatically self cleans the filter when it is obstructed.

Group 08131

#### AUTOFLUSH AUTOMATIC DISC FILTER

Code	Size	Disc filter no.	m <sup>3</sup> /h	Box	Price €	Stock
08131010	4"	2	50	1	On Request	✘
08131020	4"	3	75	1	On Request	✘
08131030	6"	5	125	1	On Request	✘
08131040	6"	6	150	1	On Request	✘
08131050	8"	7	175	1	On Request	✘
08131060	8"	8	200	1	On Request	✘



### Automatic Double Gravel (Sand-Media) Filters

Gravel filters are designed for filtration of the river, lake, pool water, and water resources containing organic materials such as lichen and alga. The outstanding advantage of the gravel filters against other types is maximum filtration efficiency due to deep filtration. Gravel filters provide ease of use, maximum filtration efficiency, and less maintenance due to their simple structure.

Group 08132

#### AUTOMATIC DOUBLE GRAVEL

Code	Size	m <sup>3</sup> /h	Box	Price €	Stock
08132010	2"x20"	10-30	1	On Request	✘
08132020	3"x24"	30-60	1	On Request	✘
08132030	4"x30"	40-80	1	On Request	✘



## Metal Screen/Disc Y Filters

Metal Screen Disc Filters are designed to ensure deep filtration as a consequence of the one-on-one order of many disc sheets manufactured from nylon reinforced polypropylene material on a filter body. Having a simpler design, screen filters are successful infiltration of water wells and water resources containing sand.

Group 08133

### DISC/SCREEN FILTER-ANGLE TYPE

Code	Size	m <sup>3</sup> /h	Box	Price €	Stock
● 08133010	2"	-	1	On Request	✘
● 08133020	3"	-	1	On Request	✘
● 08133030	4"	-	1	On Request	✘



## Hydrocyclones (Sand Separators)

Metallic Hydrocyclones are designed in a simple structure to be used in the filtration of well water or other water sources containing sand, gravel, or particles heavier than the water. It is simple, economic, and easy to use causing minimum pressure loss infiltration systems and operating at maximum efficiency.

Group 08134

### HYDROCYCLONE

Code	Size	m <sup>3</sup> /h	Box	Price €	Stock
● 08134010	6/4"	16	1	On Request	✘
● 08134020	2"	25	1	On Request	✘
● 08134030	2 1/2"	35	1	On Request	✘
● 08134040	3"	50	1	On Request	✘
● 08134050	4"	80	1	On Request	✘



# Micro irrigation

---

The micro-irrigation system is effective in saving water and increasing water use efficiency. It helps reduce water consumption, growth of unwanted plants (weeds), soil erosion, and cost of cultivation. Microirrigation is a low-pressure, low-volume irrigation system suitable for high-return value crops such as fruit and vegetable.





## Driplines

### PoliDrip dripline

### PoliDrip Light dripline

The most suitable living conditions for the plants. The drip irrigation system is the most efficient way to irrigate your tree crops and orchards. Water drips slowly to the plant roots saving water and nutrients. A drip line system also helps conserve water, which is more of a consideration in areas where water supplies might be limited

### Features

- Provides the most suitable life conditions for the plants
- Makes it possible for the water with the nutritive materials to get to the roots of the plants in a short way
- Provides an appropriate proportion of the water and the air in the soil. The ideal circumstances for the development of the plants
- Guarantees considerable quantity of the yield and a better quality besides lower expenses
- Reduces the weeds, and so the costs originating from this
- The simple operation and control of the irrigation system save a lot of time and costs
- Water application efficiency is high if managed correctly
- Fields with irregular shapes are easily accommodated
- Recycled non-potable water can be safely used
- Soil erosion and weed growth is decreased
- Water distribution is highly uniform, controlled by the output of each nozzle
- Fertigation can easily be included with minimal waste of fertilizers
- Foliage remains dry, reducing the risk of disease
- Usually operated at a lower pressure than other types of pressurized irrigation, reducing energy costs
- Dripline irrigation can greatly reduce or eliminate water waste while promoting healthier plant growth

### Specifications and Technical data

Pipe material	Polyethylene (PE) - black / brown
Emitter material	Polyethylene (PE) - gray /blue /green
Operating Pressure	0.4 - 4.5 bar
Package	100 / 300 m
Distance between drippers	Min. 20 cm
Dripper discharge	1 l/h – 2 l/h – 4 l/h
Dripper Type	Non-PC / Pressure Compensated (PC)
Wall thickness	<b>PoliDrip dripline:</b> Ø16 mm: 1.0 - 1.1 mm (44 mil) Ø20 mm: 1.1 - 1.2 mm (47 mil) <b>PoliDrip Light dripline:</b> Ø16 mm: 1.0 - 1.1 mm (35 mil) Ø20 mm: 1.1 - 1.2 mm (40 mil)
Pipe diameter	16 mm / 20 mm
Working terms	<ul style="list-style-type: none"> <li>• Expert planning and installation</li> <li>• Non-return and air valve installation</li> <li>• Physical, biological and chemical filtering (min. 120 mesh)</li> <li>• Fertilization and acid treatment</li> <li>• Regular flushing of the system</li> </ul>
Field of use	<ul style="list-style-type: none"> <li>• Greenhouses</li> <li>• Orchards, seedlings</li> <li>• Growing ornamental plants</li> <li>• Decorative gardens</li> <li>• Parks</li> </ul>
Standard	ISO 9261

## PoliDrip Driplines

Used to deliver the water directly to the roots of plants. Dripline has emitters placed at intervals along the pipe which correspond with the placement of each plant. This ensures that water is delivered directly to each plant's root zone. This method of irrigation is not only very precise and efficient, but it also saves water because of low water discharge and minimized evaporation loss.



Size: Ø16 and Ø20 mm  
 Operating Pressure: 1.1 - 1.5 bar  
 Wall thickness: Ø16: 1.0 - 1.1 mm  
 Ø20: 1.1 - 1.2 mm

### PoliDrip Non-PC driplines

Non-PC dripline is used for applications when a drip irrigation system is required for orchards, vineyards, and greenhouses with regular plant spacing with NO slope. Built-in Quality and Durability from premium polyethylene and additives for resistance to UV degradation. Comes in various types and sizes 16 and 20 mm in diameter.

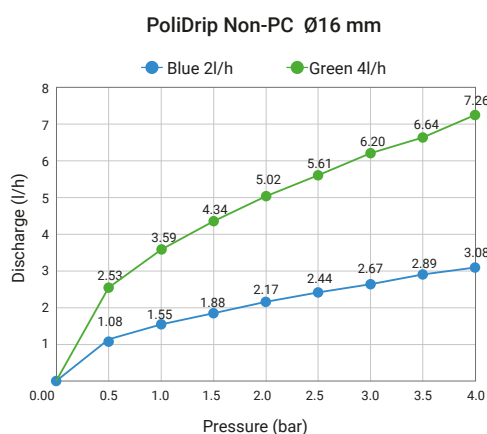
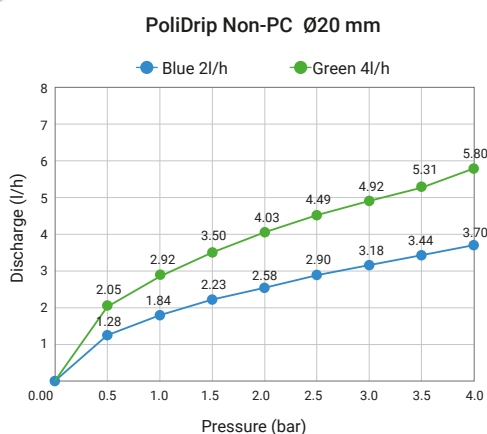

### PoliDrip® Non PC

#### Equal dripper distance / Maximum pipe length in meters

Diameter	Discharge	Pressure	25 cm	33 cm	50 cm	60 cm	75 cm	100 cm
16 mm	2 l/h	1.5 bar	54	64	103	129	142	177
16 mm	4 l/h	1.5 bar	47	62	91	99	111	130
20 mm	2 l/h	1.5 bar	58	75	115	135	170	220
20 mm	4 l/h	1.5 bar	52	67	105	120	130	140

### Fittings and valves for driplines

- Safe and fast way of connecting drip irrigation setup
- Easy assemble and reassemble, no tool or additional clamp required
- Assure additional protection even on uneven ground
- Specifically used for low-pressure connection

#### \* Quick Joints



Find out more on page 45

#### Lock Type Fittings



Find out more on page 47

#### Barbed Fittings



Find out more on page 49

#### Cylinder MINI Valves



Find out more on page 61

#### Cylinder Valves



Find out more on page 64

\* Quick joint and Cylinder MINI valves beside standard dripline and PE pipes, fit also the thin-wall dripline

Group 09100

**POLIDRIP® NON-PC**

Operating pressure: 1.1 – 1.5 bar

Ø16 mm 44 mil 100 m Roll			
Code	Spacing	Price €	Stock
<b>1.0 l/h</b>			
09100053	33 cm	0.409	✗
09100093	50 cm	0.367	✗
<b>2.0 l/h</b>			
09100033	25 cm	0.367	✗
09100063	33 cm	0.350	✓
09100103	50 cm	0.334	✓
09100123	60 cm	0.325	✗
09100143	75 cm	0.325	✗
09100163	100 cm	0.317	✗
<b>4.0 l/h</b>			
09100043	25 cm	0.375	✗
09100073	33 cm	0.359	✓
09100113	50 cm	0.334	✗
09100133	60 cm	0.334	✗
09100153	75 cm	0.325	✗
09100173	100 cm	0.317	✗



**300 m Roll**

Code	Spacing	Price €	Stock
<b>1.0 l/h</b>			
09100056	33 cm	0.400	✗
09100096	50 cm	0.367	✗
<b>2.0 l/h</b>			
09100036	25 cm	0.367	✗
09100066	33 cm	0.350	✓
09100106	50 cm	0.334	✓
09100126	60 cm	0.325	✗
09100146	75 cm	0.325	✗
09100166	100 cm	0.317	✗
<b>4.0 l/h</b>			
09100046	25 cm	0.375	✗
09100076	33 cm	0.359	✓
09100116	50 cm	0.334	✓
09100136	60 cm	0.334	✗
09100156	75 cm	0.325	✗
09100176	100 cm	0.317	✗



**AGTERA Non-PC dripper**

Only in Ø16 mm, 2 l and 4 l dripline

Compact NON-PC dripper with unique clogging resistance, for well water. The Agtera dripper employs an extra-large flow path cross-section, long labyrinth, and elevated filter - agricultural dripper with excellent clogging resistance.

**ADVANTAGES AND BENEFITS**

**Exceptionally Uniform Flow** - Dripper CV of <3% ensures flow uniformity between drip outlets.

**Compact** - long flow path and economical size.

**High Performance** - Longer pipe runs with <0.5 emitting exponents and 2:1 pressure loss to flow loss.

**Design** - The specialized design eliminates labyrinth dead zones to maintain consistent turbulence, reduce the settling of suspended solids and prevents clogging.

**Highly Clog-resistant** - The long labyrinth and large cross-sectional design ensure sedimentation on the labyrinth surface does not clog the emitter.

**Elevated Filter** - The elevated filter draws from water closer to the pipe center, where water travels at high velocity keeping the filter surface clean. The elevated filter entrance inhibits solids from setting on it between flow cycles, regardless of dripper orientation in the pipe.

**Built-in Quality and Durability** - Constructed with 100% premium virgin polyethylene and additives. Resistant to UV, commonly used chemicals and fertilizers.

Group 09100

**POLIDRIP® NON-PC - DRIPLINE**

Operating pressure: 1.1 – 1.5 bar

Ø20 mm 47 mil 100 m Roll			
Code	Spacing	Price €	Stock
<b>2.0 l/h</b>			
09100323	25 cm	0.567	✗
09100343	33 cm	0.525	✓
09100393	50 cm	0.492	✗
09100413	60 cm	0.475	✗
09100433	75 cm	0.459	✗
09100473	100 m	0.450	✗
<b>4.0 l/h</b>			
09100333	25 cm	0.567	✗
09100353	33 cm	0.525	✓
09100403	50 cm	0.484	✗
09100423	60 cm	0.475	✗
09100443	75 cm	0.459	✗
09100483	100 m	0.450	✗



**300 m Roll**

Code	Spacing	Price €	Stock
<b>2.0 l/h</b>			
09100326	25 cm	0.567	✗
09100346	33 cm	0.525	✗
09100396	50 cm	0.484	✓
09100416	60 cm	0.475	✗
09100436	75 cm	0.459	✗
09100476	100 m	0.450	✗
<b>4.0 l/h</b>			
09100336	25 cm	0.567	✗
09100356	33 cm	0.525	✓
09100406	50 cm	0.484	✗
09100426	60 cm	0.475	✗
09100446	75 cm	0.459	✗
09100486	100 m	0.450	✗



**Poliext SG Non-PC dripper**

Only in Ø20 mm dripline

- Delivers uniform flow
- Clog-resistant and low maintenance.
- Durable and resistant to UV radiation.
- The flow varies on uneven terrain. Every dripper emits a different quantity of water depending on its location on the drip line.
- Excellent for vineyards and permanent crops that require minimal elevation and pressure variations.
- Excellent for gravity irrigation systems, as they require no pressure to work.

Group 09110

**POLIDRIP® GARDEN NON-PC - DRIPLINE**

Operating pressure: 1.1 – 1.5 bar

Ø16 mm 44 mil 100 m Roll			
Code	Spacing	Price €	Stock
<b>2.0 l/h</b>			
09110020	33 cm	0.375	✗
09110040	50 cm	0.359	✗



Ø20 mm 47 mil 100 m Roll			
Code	Spacing	Price €	Stock
<b>4.0 l/h</b>			
09110110	33 cm	0.550	✗
09110130	50 cm	0.509	✗





Size: Ø16 and Ø20 mm  
 Operating Pressure: 0.5 – 4.5 bar  
 Wall thickness: Ø16: 1.0 - 1.1 mm  
 Ø20: 1.1 - 1.2 mm

PoliDrip PC driplines

The pressure-compensated dripline is ideal for permanent crops such as vineyards and orchards with the ground with slope and regular plant spacing. PC pressure-compensated drippers deliver a uniform flow rate no matter how difficult topographical or water conditions. This product is produced with a “PC2” dripper, which is characterized by a large turbulent flow path, double filtration inlets, and a wide pressure compensation range. The dual self-flushing mechanism significantly decreases maintenance time.

PoliDrip PC Ø20 mm 1.5 - 2.3 - 3.9 l/h

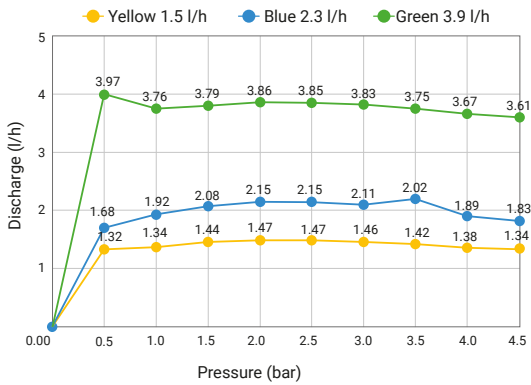

PoliDrip PC Ø16 mm 1.2 - 1.4 - 2.3 - 3.9 l/h

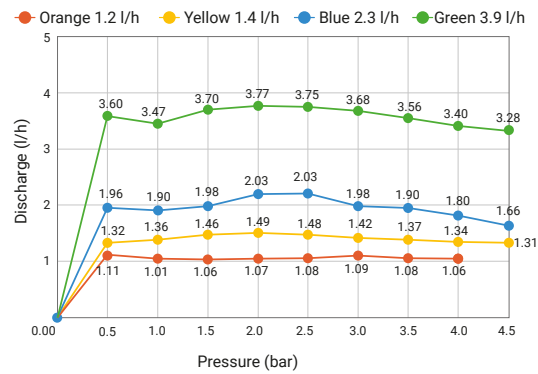

PoliDrip® PC

Equal dripper distance / Maximum pipe length in meters

Diameter	Discharge	Pressure	25 cm	33 cm	50 cm	60 cm	75 cm	100 cm
16 mm	1.2 l/h	3.5 bar	170	215	303	345	419	493
16 mm	1.4 l/h	4.5 bar	155	210	292	342	408	516
16 mm	2.3 l/h	4.5 bar	108	132	202	237	301	364
16 mm	3.9 l/h	4.5 bar	80	107	148	170	205	257
20 mm	1.5 l/h	4.5 bar	222	265	403	480	572	741
20 mm	2.3 l/h	4.5 bar	170	217	308	354	425	555
20 mm	3.9 l/h	4.5 bar	112	145	210	241	290	370

Group 09120

**POLIDRIP PC - PRESSURE COMPENSATED DRIPLINE**

Operating pressure: 0.5 - 4.5 bar



Ø16 mm 44 mil 100 m Roll				300 m Roll			
Code	Spacing	Price €	Stock	Code	Spacing	Price €	Stock
<b>1.2 l/h</b>				<b>1.2 l/h</b>			
09120243	33 cm	0.517	✗	09120246	33 cm	0.517	✗
09120253	50 cm	0.442	✗	09120256	50 cm	0.442	✗
<b>1.5 l/h</b>				<b>1.5 l/h</b>			
09120213	33 cm	0.550	✗	09120216	33 cm	0.550	✗
09120223	50 cm	0.467	✗	09120226	50 cm	0.467	✗
<b>2.3 l/h</b>				<b>2.3 l/h</b>			
09120013	25 cm	0.634	✗	09120016	25 cm	0.634	✗
09120033	33 cm	0.559	✓	09120036	33 cm	0.559	✓
09120053	50 cm	0.467	✓	09120056	50 cm	0.467	✓
09120073	60 cm	0.442	✗	09120076	60 cm	0.442	✗
09120092	75 cm	0.417	✗	09120096	75 cm	0.409	✗
09120133	100 cm	0.384	✗	09120136	100 cm	0.384	✗
<b>3.9 l/h</b>				<b>3.9 l/h</b>			
09120023	25 cm	0.609	✗	09120026	25 cm	0.609	✗
09120043	33 cm	0.542	✓	09120046	33 cm	0.534	✓
09120063	50 cm	0.459	✗	09120066	50 cm	0.459	✓
09120083	60 cm	0.434	✗	09120086	60 cm	0.434	✗
09120103	75 cm	0.409	✗	09120106	75 cm	0.400	✗
09120143	100 cm	0.375	✗	09120146	100 cm	0.375	✗

Group 09120

**POLIDRIP PC - PRESSURE COMPENSATED DRIPLINE**

Operating pressure: 0.5 - 4.5 bar



Ø20 mm 47 mil 100 m Roll				300 m Roll			
Code	Spacing	Price €	Stock	Code	Spacing	Price €	Stock
<b>1.5 l/h</b>				<b>1.5 l/h</b>			
09120533	33 cm	0.675	✗	09120536	33 cm	0.675	✗
09120543	50 cm	0.584	✓	09120546	50 cm	0.584	✓
<b>2.3 l/h</b>				<b>2.3 l/h</b>			
09120303	25 cm	0.725	✗	09120306	25 cm	0.725	✗
09120323	33 cm	0.650	✗	09120326	33 cm	0.650	✓
09120353	50 cm	0.575	✗	09120356	50 cm	0.567	✗
09120373	60 cm	0.542	✗	09120376	60 cm	0.542	✗
09120393	75 cm	0.517	✗	09120396	75 cm	0.517	✗
09120413	100 m	0.492	✗	09120416	100 cm	0.492	✗
<b>3.9 l/h</b>				<b>3.9 l/h</b>			
09120313	25 cm	0.725	✗	09120316	25 cm	0.717	✗
09120333	33 cm	0.650	✓	09120336	33 cm	0.650	✓
09120363	50 cm	0.567	✗	09120366	50 cm	0.567	✗
09120383	60 cm	0.542	✗	09120386	60 cm	0.542	✗
09120403	75 cm	0.517	✗	09120406	75 cm	0.517	✗
09120423	100 cm	0.492	✗	09120426	100 cm	0.492	✗

**PC2 dripper**  
pressure compensated

Flow Rates: 1.2 - 3.9 l/h  
 Flow Rates/Diameter: 16 and 20 mm  
 Dripper Spacings: minimum 20 cm  
 Wall Thickness/mm: Standard 1.0 - 1.1  
 Outlet Type: 4 hole outlet  
 Operating Pressure: 0.5 - 4.5 bar

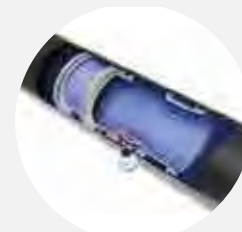

**Applications**

- Ideal for permanent crops such as vineyards and orchards in undulating or slope terrain
- For on-surface installations

**Features and Benefits**

- Large turbulent flow path, double filtration inlets, and a wide pressure compensation range (0.5 - 4.5 bar)
- Dual Self-Flushing Mechanism flushes at every start-up ensuring reliable operation and less maintenance
- Provides for a high water distribution uniformity, even with significant field elevation changes and in undulating terrain

**Specification**

- Turbulent high-flow, double-entry drippers
- The highest compensation pressure range (0.5 - 4.5 bar) in the industry, delivering optimum performance
- Pressure Compensation with PC2 membrane
- Dual self-flushing mechanism in each start the operation, providing low daily and annual maintenance



## Group 09130

**POLIDRIP PCND - NO DRAIN PRESSURE COMPENSATED DRIPLINE**

Operating pressure: 0.6 - 3.5 bar



Ø16 mm				Ø16 mm			
44 mil		50 m Roll		44 mil		100 m Roll	
Code	Spacing	Price €	Stock	Code	Spacing	Price €	Stock
<b>1.35 l/h</b>				<b>1.35 l/h</b>			
09130132	33 cm	0.593	✘	09130133	33 cm	0.575	✘
<b>2.35 l/h</b>				<b>2.35 l/h</b>			
09130142	33 cm	0.593	✘	09130143	33 cm	0.575	✘

## Group 09110

**POLIDRIP GARDEN PC DRIPLINES**

Operating pressure: 0.5 - 4.5 bar



Ø16 mm				Ø20 mm			
44 mil		100 m Roll		47 mil		100 m Roll	
Code	Spacing	Price €	Stock	Code	Spacing	Price €	Stock
<b>2.3 l/h</b>				<b>2.0 l/h</b>			
09110210	33 cm	0.584	✘	09110260	33 cm	0.675	✘

**NOTE**

- Polidrip PC (No Drain) we DO NOT keep on stock
- For more information please contact our sales department.

**PCND dripper no drain pressure compensated**

Available in 16 mm dripline

Flow Rates: 1.35 - 2.35 l/h  
 Flow Rates/Diameter: 16 and 20 mm  
 Dripper Spacings: 33 cm  
 Operating Pressure: 0.6 - 3.5 bar



No drain pressure compensated dripline is used for applications when a highly reliable and accurate dripper is required (pulse irrigation, subsurface, and highly undulating ground, also ideal for greenhouse applications). In addition to pressure compensating, the dripper seals close if the pressure falls below 0,1 bar to stop water from draining out of the tube and shut off. The No-drain system option provides that the dripline remains full of water between irrigation intervals, ensuring immediate and uniform irrigation along the dripline. Available only in diameter 16 mm.

**APPLICATIONS**

Pulse irrigation, subsurface, and highly undulating ground are ideal for greenhouses.

**FEATURES AND BENEFITS**

In addition to pressure compensating, the dripper seals when the pressure drops below 0.1 bar to stop water from draining out of the tube at shut off.



Size: Ø16 and Ø20 mm  
 Operating Pressure: 1.1 – 1.5 bar  
 Wall thickness: Ø16: 0.8 - 0.9 mm  
 Ø20: 0.9 - 1.0 mm

PoliDrip Light Non-PC

Thin-wall Non-PC dripline is used for applications when the drip irrigation system is required for orchards, vineyards, and greenhouses with regular plant spacing with NO slope. Built-in Quality and Durability from premium virgin polyethylene and additives for resistance to UV degradation. Comes in various types and sizes range from diameter 16 and 20 mm.

PoliDrip Light Non-PC Ø16 mm 2l/h - 4l/h

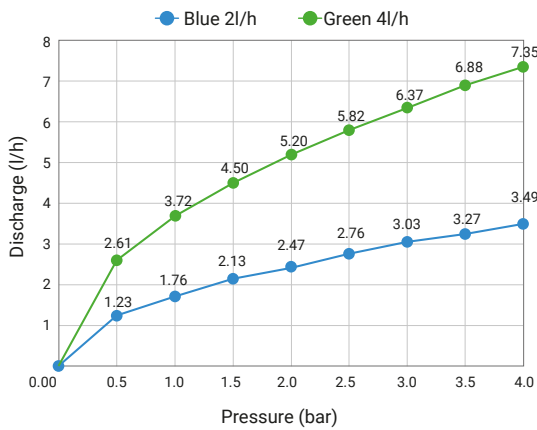

PoliDrip Light Non-PC Ø20 mm 2l/h - 4 l/h

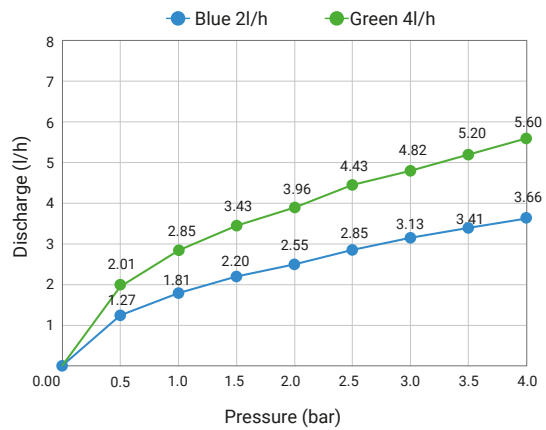

PoliDrip® Light Non-PC

Equal dripper distance / Maximum pipe length in meters

Diameter	Discharge	Pressure	25 cm	33 cm	50 cm	60 cm	75 cm	100 cm
16 mm	2.0 l/h	1.5 bar	50	60	93	120	132	165
16 mm	4.0 l/h	1.5 bar	43	53	84	91	100	116
20 mm	2.0 l/h	1.5 bar	52	68	106	124	156	202
20 mm	4.0 l/h	1.5 bar	47	57	55	108	118	128

Fittings and valves for driplines

- Safe and fast way of connecting drip irrigation setup
- Easy assemble and reassemble, no tool or additional clamp required
- Assure additional protection even on uneven ground
- Specifically used for low-pressure connection

\* Quick Joints



Find out more on page 45

Lock Type Fittings



Find out more on page 47

Barbed Fittings



Find out more on page 49

Cylinder MINI Valves



Find out more on page 61

Cylinder Valves



Find out more on page 64

\* Quick joint and Cylinder MINI valves beside standard dripline and PE pipes, fit also the thin-wall dripline

Group 09140

**POLIDRIP LIGHT - NON PC DRIPLINE**

Operating pressure: 1.1 - 1.5 bar



Ø16 mm 35 mil 100 m Roll				300 m Roll			
Code	Spacing	Price €	Stock	Code	Spacing	Price €	Stock
<b>2.0 l/h</b>				<b>2.0 l/h</b>			
09140033	25 cm	0.325	✗	09140036	25 cm	0.325	✗
09140063	33 cm	0.309	✗	09140066	33 cm	0.309	✗
09140093	50 cm	0.292	✗	09140096	50 cm	0.284	✗
09140123	60 cm	0.284	✗	09140126	60 cm	0.284	✗
09140153	75 cm	0.275	✗	09140156	75 cm	0.275	✗
09140193	100 cm	0.267	✗	09140196	100 cm	0.267	✗
<b>4.0 l/h</b>				<b>4.0 l/h</b>			
09140043	25 cm	0.325	✗	09140046	25 cm	0.325	✗
09140073	33 cm	0.309	✗	09140076	33 cm	0.309	✗
09140103	50 cm	0.292	✗	09140106	50 cm	0.292	✗
09140133	60 cm	0.284	✗	09140136	60 cm	0.284	✗
09140163	75 cm	0.275	✗	09140166	75 cm	0.275	✗
09140203	100 cm	0.275	✗	09140206	100 cm	0.267	✗

Group 09140

**POLIDRIP LIGHT - NON PC DRIPLINE**

Operating pressure: 1.1 - 1.5 bar



Ø20 mm 40 mil 100 m Roll				300 m Roll			
Code	Spacing	Price €	Stock	Code	Spacing	Price €	Stock
<b>2.0 l/h</b>				<b>2.0 l/h</b>			
09140303	25 cm	0.500	✗	09140306	25 cm	0.500	✓
09140323	33 cm	0.467	✗	09140326	33 cm	0.467	✓
09140343	50 cm	0.425	✗	09140346	50 cm	0.425	✗
09140363	60 cm	0.409	✗	09140366	60 cm	0.409	✗
09140383	75 cm	0.400	✗	09140386	75 cm	0.400	✗
09140403	100 cm	0.384	✗	09140406	100 cm	0.384	✗
<b>4.0 l/h</b>				<b>4.0 l/h</b>			
09140313	25 cm	0.492	✗	09140316	25 cm	0.492	✗
09140333	33 cm	0.459	✗	09140336	33 cm	0.459	✗
09140353	50 cm	0.425	✗	09140356	50 cm	0.425	✗
09140373	60 cm	0.409	✗	09140376	60 cm	0.409	✗
09140393	75 cm	0.400	✗	09140396	75 cm	0.392	✗
09140413	100 cm	0.384	✗	09140416	100 cm	0.384	✗



**AGTERA Non-PC dripper**

Only in Ø16 mm, 2 l and 4 l dripline

Compact NON-PC dripper with unique clogging resistance, for well water. The Agtera dripper employs an extra-large flow path cross-section, long labyrinth, and elevated filter - agricultural dripper with excellent clogging resistance.

**ADVANTAGES AND BENEFITS**

**Exceptionally Uniform Flow** - Dripper CV of <3% ensures flow uniformity between drip outlets.

**Compact** - long flow path and economical size.

**High Performance** - Longer pipe runs with <0.5 emitting exponents and 2:1 pressure loss to flow loss.

**Design** - The specialized design eliminates labyrinth dead zones to maintain consistent turbulence, reduce the settling of suspended solids and prevents clogging.

**Highly Clog-resistant** - The long labyrinth and large cross-sectional design ensure sedimentation on the labyrinth surface does not clog the emitter.

**Elevated Filter** - The elevated filter draws from water closer to the pipe center, where water travels at high velocity keeping the filter surface clean. The elevated filter entrance inhibits solids from setting on it between flow cycles, regardless of dripper orientation in the pipe.

**Built-in Quality and Durability** - Constructed with 100% premium virgin polyethylene and additives. Resistant to UV, commonly used chemicals and fertilizers.



**Polixt SG Non-PC dripper**

Only in Ø20 mm dripline

- Delivers uniform flow
- Clog-resistant and low maintenance.
- Durable and resistant to UV radiation.
- The flow varies on uneven terrain. Every dripper emits a different quantity of water depending on its location on the drip line.
- Excellent for vineyards and permanent crops that require minimal elevation and pressure variations.
- Excellent for gravity irrigation systems, as they require no pressure to work.



Size: Ø16 and Ø20 mm  
 Operating Pressure: 0.5 – 4.5 bar  
 Wall thickness: Ø16: 0.8 - 0.9 mm  
 Ø20: 0.9 - 1.0 mm

### PoliDrip Light PC

Thin-wall pressure compensated dripline ideal for permanent crops such as vineyards and orchards on uneven land or with regular plant spacing. PC Online pressure-compensated drippers deliver a uniform flow rate no matter how difficult the topographical or water conditions are. The PC2 dripper is characterized by large turbulent flow path, double filtration inlets and a wide pressure compensation range. Dual self-flushing mechanism significantly decreases maintenance time.

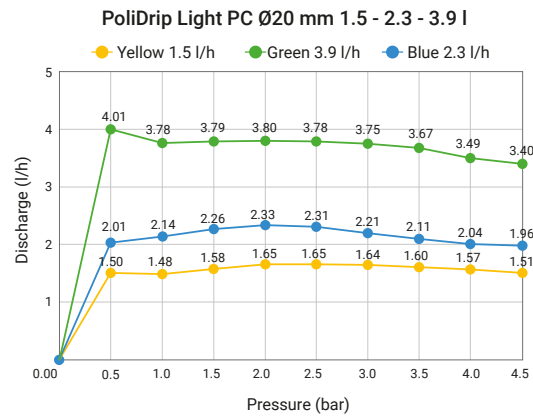
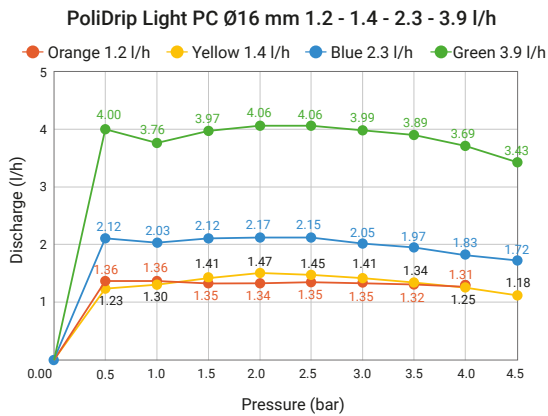

### PoliDrip® Light PC

#### Equal dripper distance / Maximum pipe length in meters

Diameter	Discharge	Pressure	25 cm	33 cm	50 cm	60 cm	75 cm	100 cm
16 mm	1.2 l/h	3.5 bar	152	189	265	302	363	435
16 mm	1.4 l/h	3.5 bar	141	180	255	293	351	442
16 mm	2.3 l/h	3.5 bar	98	121	182	213	255	317
16 mm	3.9 l/h	3.5 bar	70	85	131	152	180	227
20 mm	1.5 l/h	3.5 bar	1987	245	358	420	503	628
20 mm	2.3 l/h	3.5 bar	149	185	271	307	374	475
20 mm	3.9 l/h	3.5 bar	100	131	185	214	258	335

Group 09150

**POLIDRIP LIGHT PC - PRESSURE**

Operating pressure: 0.5 - 4.5 bar

**COMPENSATED DRIPLINE**



Ø16 mm 35 mil 100 m Roll				300 m Roll			
Code	Spacing	Price €	Stock	Code	Spacing	Price €	Stock
<b>2.0 l/h</b>				<b>2.0 l/h</b>			
09150013	25 cm	0.584	✗	09150016	25 cm	0.584	✗
09150033	33 cm	0.509	✗	09150036	33 cm	0.509	✗
09150053	50 cm	0.425	✗	09150056	50 cm	0.425	✗
09150073	60 cm	0.392	✗	09150076	60 cm	0.392	✗
09150093	75 cm	0.367	✗	09150096	75 cm	0.367	✗
09150113	100 cm	0.342	✗	09150116	100 cm	0.334	✗
<b>4.0 l/h</b>				<b>4.0 l/h</b>			
09150023	25 cm	0.559	✗	09150026	25 cm	0.559	✗
09150043	33 cm	0.492	✗	09150046	33 cm	0.492	✗
09150063	50 cm	0.409	✗	09150066	50 cm	0.409	✗
09150083	60 cm	0.375	✗	09150086	60 cm	0.375	✗
09150103	75 cm	0.359	✗	09150106	75 cm	0.359	✗
09150123	100 cm	0.334	✗	09150126	100 cm	0.334	✗

Group 09150

**POLIDRIP LIGHT PC - PRESSURE**

Operating pressure: 0.5 - 4.5 bar

**COMPENSATED DRIPLINE**



Ø20 mm 40 mil 100 m Roll				300 m Roll			
Code	Spacing	Price €	Stock	Code	Spacing	Price €	Stock
<b>2.0 l/h</b>				<b>2.0 l/h</b>			
09150133	25 cm	0.659	✗	09150136	25 cm	0.659	✗
09150153	33 cm	0.592	✗	09150156	33 cm	0.592	✗
09150173	50 cm	0.509	✗	09150176	50 cm	0.509	✗
09150193	60 cm	0.475	✗	09150196	60 cm	0.475	✗
09150213	75 cm	0.450	✗	09150216	75 cm	0.450	✗
09150233	100 cm	0.425	✗	09150236	100 cm	0.425	✗
<b>4.0 l/h</b>				<b>4.0 l/h</b>			
09150143	25 cm	0.659	✗	09150146	25 cm	0.659	✗
09150163	33 cm	0.584	✗	09150166	33 cm	0.584	✗
09150183	50 cm	0.509	✗	09150186	50 cm	0.509	✗
09150203	60 cm	0.475	✗	09150206	60 cm	0.475	✗
09150223	75 cm	0.450	✗	09150226	75 cm	0.450	✗
09150243	100 cm	0.425	✗	09150246	100 cm	0.425	✗

**NOTE**

- We produce PoliDrip pipes also on special request, with different dripper spacing and coil length.
- For more information please contact our sales department.

**PC2 dripper pressure compensated**

Flow Rates: 1.2 - 3.9 l/h  
 Flow Rates/Diameter: 16 and 20 mm  
 Dripper Spacings: minimum 20 cm  
 Wall Thickness/mm: Standard 0.8 - 1.0  
 Outlet Type: 4 hole outlet  
 Operating Pressure: 2.0 - 4.0 bar

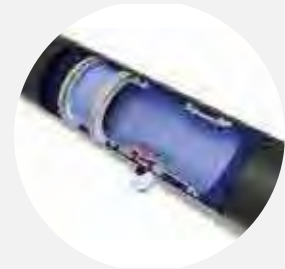

**Applications**

- Ideal for permanent crops such as vineyards and orchards in undulating or slope terrain
- For on-surface installations

**Features and Benefits**

- Large turbulent flow path, double filtration inlets and a wide pressure compensation range (0.5 - 4.5 bar)
- Dual Self-Flushing Mechanism flushes at every start-up ensuring reliable operation and less maintenance
- Provides for a high water distribution uniformity, even with significant field elevation changes and in undulating terrain

**Specification**

- Turbulent high-flow, double-entry drippers
- The highest compensation pressure range (0.5 - 4.5 bar) in the industry, delivering optimum performance
- Pressure Compensation with PC2 membrane
- Dual self-flushing mechanism in each start the operation, providing low daily and annual maintenance

Unique Anti-Siphon System



Group 09180

**ASSIF AS-PC DRIPLINES (0.9 mm)**

Operating pressure: 0.8 - 3.5 bar

Code	Spacing	Price €	Stock
<b>1.2 l/h</b>			
09180015	30 cm	0.428	✗
09180045	60 cm	0.357	✗
<b>1.6 l/h</b>			
09180025	30 cm	0.428	✗
09180055	60 cm	0.357	✓
<b>2.1 l/h</b>			
09180035	30 cm	0.428	✓
09180065	60 cm	0.357	✗

Group 09181

**ASSIF RootGuard® AS-PC DRIPLINES (0.9 mm)**

Operating pressure: 0.80 - 3.5 bar

Code	Spacing	Price €	Stock
<b>0.8 l/h</b>			
09181075	50 cm	0.439	✓
<b>1.2 l/h</b>			
09181015	30 cm	0.513	✓
09181045	50 cm	0.439	✗
<b>1.6 l/h</b>			
09181025	30 cm	0.513	✗
09181055	50 cm	0.439	✗
<b>2.1 l/h</b>			
09181035	30 cm	0.513	✗
09181065	50 cm	0.439	✓

Assif AS-PC driplines

Dripline with pressure compensated, anti-siphon system – prevents suction of sand or soil into the dripper. Wide range of operating pressures for various topographies. Unique and accurate regulating labyrinth mechanism with wide water passages along the labyrinth. Suitable for different water sources and provided with a long-lasting silicone diaphragm. Durable under harsh field conditions and chemical applications. RootGuard® configuration is available for extra protection against root intrusion in SDI (Subsurface Drip Irrigation) systems.



Code	Spacing	Price €	Stock
<b>100 m Roll</b>			
<b>2.1 l/h</b>			
09181031	30 cm	0.534	✓

Assif AS-PC dripper anti-siphon pressure compensated

Drip line:	Anti-Siphon PC
Flow Rates:	1.2 / 2.1/ 1.6 l/h
Diameter:	16 mm
Dripper Spacings:	minimum 20 cm
Wall Thickness/mm:	35 mil (0.9 mm)
Operating Pressure:	0.8 - 3.5 bar

RootGuard® configuration is available for extra protection against root intrusion in SDI systems.

FEATURES

- Especially designed for SDI application
- Wide range of operating pressure for various topographies
- Unique and accurate regulating labyrinth mechanism
- Wide water passages along the labyrinth
- Suitable for different water sources
- Long-lasting silicon diaphragm
- Durable under harsh field conditions and chemical applications

APPLICATION

- Row crops
- Orchards
- Turf and landscaping
- Vegetables
- Sugarcane
- Alfalfa
- Industrial crops

Technical Data

Inside Diameter (mm)	Wall Thickness (mm)	Min. operating Pressure (bar)	Max. operating Pressure (bar)	Kd
13.8	0.9 - 1.0	0.8	3.5	0.27

Packaging Data

Wall Thickness (mm)	Lateral Length (m) Coil/Drum	Number of Coils/Drums per Container		
		20'	40'	40' HC
0.9	500 wide	240	480	580

Max. Lateral Length, ID 15.2 mm, WT 0.6 mm, Inlet Pressure: 2.5 bar

Nominal Flow Rate (l/h)	Spacing between Drippers (m)							
	0.20	0.30	0.40	0.50	0.60	0.75	1.00	
1.2	171	228	279	325	367	426	515	
1.6	142	189	232	270	305	354	429	
2.1	119	159	194	227	256	297	360	



## Drip tapes

Thanks to emitters placed close to each other, PoliTape provides the most suitable life condition of the plants by watering the root zone. Allows the water and the nutritive materials to get to the roots of the plants in a short way. Guarantees higher quantity of the yield, simple operation and control of irrigation system, saving a lot of time and costs. The cheapest solution to use in case of water quality is low.

### Features

- Precisely shaped emitters for high uniformity of flow
- The turbulent flow-path design provides a high degree of resistance to clogging
- Available in a wide range of wall thicknesses, outlet spacings and flow rates
- High resistance to tensile and cracking
- Strong material resistance to abrasion reduces land damages
- Thanks to the versatility and reliability it is easy to install and reduces your work time
- The production of the system and its quality is in accordance with ISO 9261.

### Specifications and Technical data

<b>Tape material</b>	Polyethylene (PE)
<b>Distance between drippers</b>	10 cm - 40 cm
<b>Emitter discharge</b>	0.6 – 2.3 l/h/m
<b>Emitter type</b>	<ul style="list-style-type: none"> <li>• Silicon labyrinth</li> <li>• Flat emitter</li> </ul>
<b>Color</b>	Black with white stripe
<b>Wall thickness</b>	6 – 8 – 10 – 12 mil
<b>Diameter</b>	16 mm
<b>Operating pressure</b>	0.7 – 1.0 bar
<b>Field of use</b>	<ul style="list-style-type: none"> <li>• Greenhouses</li> <li>• Vegetables</li> <li>• Growing ornamental plants</li> <li>• Short-term cultured plantations</li> <li>• In cases where because of water quality is not cost effective to place dripping pipe system</li> </ul>
<b>Operating terms:</b>	<ul style="list-style-type: none"> <li>• Expert planning and installation</li> <li>• Non-return and air valve inst.</li> <li>• Physical, biological and chemical filtering (min. 150 mesh)</li> <li>• Fertilization and acid treatment</li> </ul>
<b>Standard</b>	ISO 9261



Tape material: Polyethylene (PE)  
 Package: 100/500/1000/2500/3000 m  
 Distance between drippers: 10 cm/15 cm/20 cm/30 cm  
 Emitter discharge: 0.6 – 1.0 – 1.5 l/h/m  
 Emitter type: Silicon labyrinth  
 Color: Black with White stripe  
 Wall thickness: 6 - 8 - 10 - 12mil  
 Diameter: 16 mm

### PoliTape

**PoliTape®** drip tape with continuous labyrinth provides high resistance to clogging and therefore longer lifetime of the system. The special system provides superior performances and uniformity of emitters. Extrusion technology utilizes high-quality specially developed polymers, renowned for their firmness and flexibility. These polymers were developed especially for use in industrial and agricultural environments. A special system of forming tapes with a constant labyrinth delivers superior performance and uniformity of drippers. The entire production is performed according to standard ISO 9261:2011.

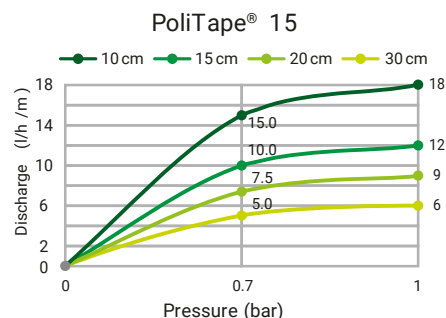
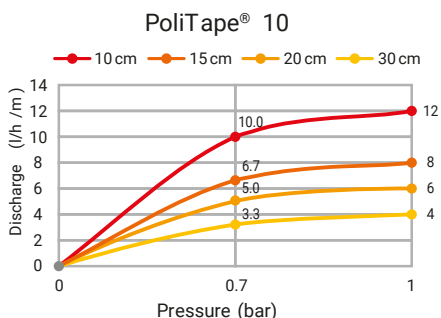
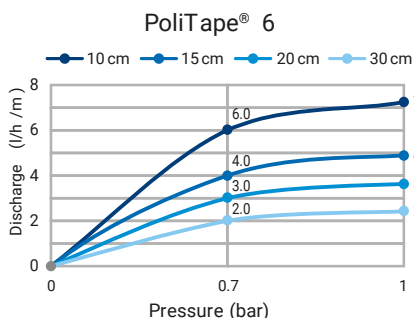

Type	Emitter spacing	Discharge l/h per meter		Discharge l/h per emitter		PoliTape® Length of the row depending on field uniformity on 0.7 bar pressure							
		0.7 bar	1 bar	0.7 bar	1 bar	Dripper flow rate	Uniformity	Space between drippers				Minimal filtration	
PoliTape 6	10 cm	6.0	7.2	0.60	0.72	0.6 l/h	90%	10 cm	15 cm	20 cm	30 cm	100	150
	15 cm	4.0	4.8					140	180	210	268		
	20 cm	3.0	3.6					170	220	260	334		
	30 cm	2.0	2.4					100	125	150	190		
PoliTape 10	10 cm	10.0	12.0	1.00	1.20	1.0 l/h	85%	10 cm	15 cm	20 cm	30 cm	100	150
	15 cm	6.5	8.0					122	160	184	236		
	20 cm	5.0	6.0					35	45	50	65		
	30 cm	3.5	4.0					75	95	115	150		
PoliTape 15	10 cm	15.0	18.0	1.50	1.80	1.5 l/h	90%	10 cm	15 cm	20 cm	30 cm	100	150
	15 cm	10.0	12.0					35	45	50	65		
	20 cm	7.5	9.0					75	95	115	150		
	30 cm	5.0	6.0					75	95	115	150		

### Group 09200

### POLITAPE DRIP TAPE - WITH LABYRINTH

Operating pressure: 0.7 - 1.0 bar



The design of a constant labyrinth provides high resistance of temperature blockage and longer use of the system, and therefore more rational utilization of water.

6 mil / 150 µm		3000 m/Reel		1000 m/Reel					
Code	Spacing	l/h/m	Price €	Stock	Code	Spacing	l/h/m	Price €	Stock
<b>Ø16 - 0.6 l/h</b>					<b>Ø16 - 0.6 l/h</b>				
09200010	10 cm	6.0	0.060	✓	09200018	10 cm	6.0	0.060	✗
09200040	15 cm	4.0	0.060	✗	09200048	15 cm	4.0	0.060	✗
09200020	20 cm	3.0	0.060	✓	09200028	20 cm	3.0	0.060	✗
09200030	30 cm	2.0	0.060	✓	09200038	30 cm	2.0	0.060	✗
<b>Ø16 - 1.0 l/h</b>					<b>Ø16 - 1.0 l/h</b>				
09200110	10 cm	10.0	0.060	✓	09200118	10 cm	10.0	0.060	✗
09200140	15 cm	6.5	0.060	✗	09200148	15 cm	6.5	0.060	✗
09200120	20 cm	5.0	0.060	✓	09200128	20 cm	5.0	0.060	✗
09200130	30 cm	3.5	0.060	✓	09200138	30 cm	3.5	0.060	✗
<b>Ø16 - 1.5 l/h</b>									
09200310	10 cm	15.0	0.060	✓					
09200340	15 cm	10.0	0.060	✗					
09200320	20 cm	7.5	0.060	✓					
09200330	30 cm	5.0	0.060	✓					





**FILTRATION**

Double-filtration of water through 110 properly positioned points.



**LABYRINTH**

Constant labyrinth of flow control



**WATER OUTPUT**

Micro-precise slit

**FEATURES AND BENEFITS**

- Precisely shaped emitters for high uniformity of flow
- Double water filtration through the 110 properly positioned points
- Micro precise slits eliminates blockages on the startup and prevents root intrusion
- The turbulent flow-path design provides a high degree of resistance to clogging
- Available in a wide range of wall thicknesses, outlet spacings, and flow rates
- Seamless construction for greater reliability
- Visible blue ribbons for better recognition and indicators emitters
- High resistance to tensile and cracking
- Strong material resistance to abrasion reduces land damages
- Thanks to the versatility and reliability it is easy to install and reduces your work time
- The production of the system and its quality is following ISO 9261

Group 09210

**POLITAPE DRIP TAPE - WITH LABYRINTH**

Operating pressure: 0.7- 1.0 bar

8 mil / 200 µm					2500 m/Reel					1000 m/Reel				
Code	Spacing	l/h/m	Price €	Stock	Code	Spacing	l/h/m	Price €	Stock	Code	Spacing	l/h/m	Price €	Stock
<b>Ø16 - 0.6 l/h</b>					<b>Ø16 - 0.6 l/h</b>					<b>Ø16 - 0.6 l/h</b>				
09210010	10 cm	6.0	0.066	✗	09210018	10 cm	6.0	0.066	✗	09210018	10 cm	6.0	0.066	✗
09210040	15 cm	4.0	0.066	✗	09210048	15 cm	4.0	0.066	✗	09210048	15 cm	4.0	0.066	✗
09210020	20 cm	3.0	0.066	✗	09210028	20 cm	3.0	0.066	✗	09210028	20 cm	3.0	0.066	✗
09210030	30 cm	2.0	0.066	✗	09210038	30 cm	2.0	0.066	✗	09210038	30 cm	2.0	0.066	✗
<b>Ø16 - 1.0 l/h</b>					<b>Ø16 - 1.0 l/h</b>					<b>Ø16 - 1.0 l/h</b>				
09210110	10 cm	10.0	0.066	✗	09210118	10 cm	10.0	0.066	✗	09210118	10 cm	10.0	0.066	✗
09210140	15 cm	6.5	0.066	✗	09210148	15 cm	6.5	0.066	✗	09210148	15 cm	6.5	0.066	✗
09210120	20 cm	5.0	0.066	✗	09210128	20 cm	5.0	0.066	✗	09210128	20 cm	5.0	0.066	✗
09210130	30 cm	3.5	0.066	✗	09210138	30 cm	3.5	0.066	✗	09210138	30 cm	3.5	0.066	✗
<b>Ø16 - 1.5 l/h</b>														
09210310	10 cm	15.0	0.066	✗										
09210340	15 cm	10.0	0.066	✗										
09210320	20 cm	7.5	0.066	✗										
09210330	30 cm	5.0	0.066	✗										

10 mil / 250 µm					2000 m/Reel				
Code	Spacing	l/h/m	Price €	Stock					
<b>Ø16 - 0.6 l/h</b>									
09215020	20 cm	3.0	0.073	✗					
<b>Ø16 - 1.0 l/h</b>									
09215120	20 cm	5.0	0.073	✗					

12 mil / 300 µm					1500 m/Reel				
Code	Spacing	l/h/m	Price €	Stock					
<b>Ø16 - 0.6 l/h</b>									
09218020	20 cm	3.0	0.080	✗					
09218030	30 cm	2.0	0.080	✗					
<b>Ø16 - 1.0 l/h</b>									
09218110	10 cm	10.0	0.080	✗					
09218130	30 cm	3.5	0.080	✗					

**Fittings and valves for driptapes**

• Safe and fast way of connecting drip irrigation setup

• Easy assemble and reassemble, no tool or additional clamp required

• Assure additional protection even on uneven ground

• Specifically used for low-pressure connection

• Tape fittings with the ring can not be used for drip tape with labyrinth (PoliTape).

Tape Fittings



Find out more on page 53

Cylinder MINI Valves



Find out more on page 61

Cylinder Valves



Find out more on page 64



Tape material: Polyethylene (PE)  
 Package: 100/500/1000/2500/3000 m  
 Distance between drippers: 10 cm/15 cm/20 cm/30 cm  
 Emitter discharge: 0.6 – 1.0 – 1.5 l/h/m  
 Emitter type: Silicon labyrinth  
 Color: Black with White stripe  
 Wall thickness: 6 - 8 - 10 - 12 mil  
 Diameter: 16 mm

PoliFlat

**PoliFlat®** is the drip tape model with flat emitters. Emitters with double positioned filtration provide the highest clogging protection. The largest area of filtration on the market is set over the entire length of the emitter. Extrusion technology utilizes high-quality specially developed polymers, renowned for their firmness and flexibility. These polymers were developed especially for use in industrial and agricultural environments. The entire production is performed according to standard EN ISO 9261.

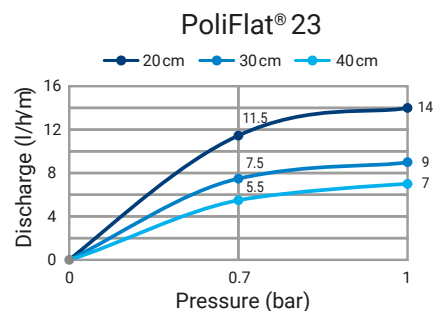
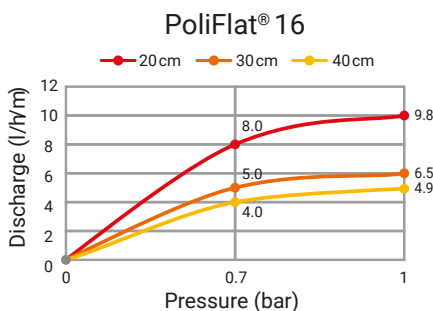
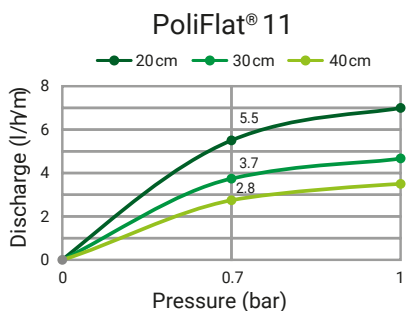

Type	Emitter spacing	Discharge l/h per meter		Discharge l/h per emitter		PoliFlat® Length of the row depending on field uniformity on 0.7 bar pressure													
		0.7 bar	1 bar	0.7 bar	1 bar	Dripper flow rate	Uniformity	Space between drippers			Minimal filtration								
		20 cm	30 cm	40 cm	20 cm			30 cm	40 cm	microns	mesh								
PoliTape Flat 11	20 cm	5.5	6.8	1.10	1.35	1.1 l/h	90%	138	180	216	100	150							
	30 cm	3.7	4.5																
	40 cm	2.8	3.4																
PoliTape Flat 16	20 cm	8.0	9.8	1.60	1.95								1.6 l/h	85%	170	222	267	100	150
	30 cm	5.0	6.5																
	40 cm	4.0	4.9																
PoliTape Flat 23	20 cm	11.5	14.0	2.30	2.80	1.6 l/h	85%	110	140	170	100	150							
	30 cm	7.5	9.0																
	40 cm	5.5	7.0																

Group 09190

**POLIFLAT DRIP TAPE - WITH FLAT EMITTERS**

Operating pressure: 0.7 - 1.0 bar

**6 mil / 150 µm      3000 m/Reel**

**1000 m/Reel**

Code	Spacing	l/h/m	Price €	Stock
<b>Ø16 - 1.1 l/h</b>				
09190420	20 cm	5.5	0.060	✗
09190430	30 cm	3.7	0.060	✗
09190440	40 cm	2.8	0.060	✗
<b>Ø16 - 1.6 l/h</b>				
09190220	20 cm	8.0	0.060	✗
09190230	30 cm	5.0	0.060	✗
09190240	40 cm	2.75	0.060	✗
<b>Ø16 - 2.3 l/h</b>				
09190020	20 cm	11.5	0.060	✗
09190030	30 cm	7.5	0.060	✗
09190040	40 cm	5.75	0.060	✗

Code	Spacing	l/h/m	Price €	Stock
<b>Ø16 - 2.3 l/h</b>				
09190028	20 cm	11.5	0.060	✗
09190038	30 cm	7.5	0.060	✗
09190048	40 cm	5.75	0.060	✗



Emitters positioned with double filtration providing maximum protection against clogging. A low coefficient of variation provides high uniformity in the use.

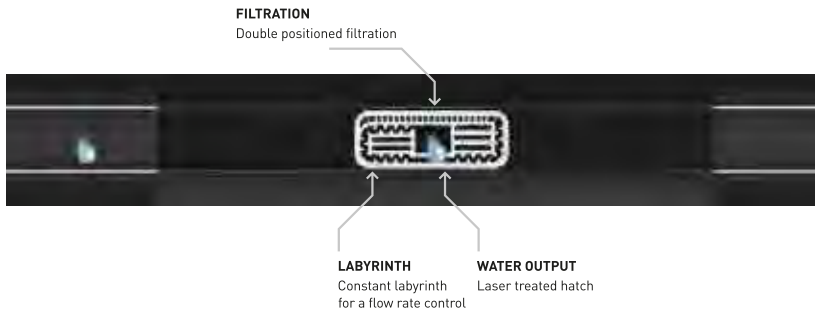

**FEATURES AND BENEFITS**

- Construction without overlap for greater resistance to the pressures of type
- Design and production technologies guarantee a high level of the filter part and a high level of protection against clogging
- Precisely drilled holes using laser technology
- Extremely low coefficient of variation (CV) provides high uniformity in the use of
- High resistance to cracking and stretching
- Visible white lines for better positioning of the setting of a tape
- It is available in different wall thickness, emitter spacing, and flow
- Solid material, resistant to abrasion, reducing land degradation
- Easy installation thanks to the versatility and reliability
- Production and quality control are following the international standard EN ISO 9261:2011

Group 09190

**POLIFLAT DRIP TAPE - WITH FLAT EMITTERS**

Operating pressure: 0.7 - 1.0 bar

8 mil / 200 µm				2500 m/Reel				1000 m/Reel			
Code	Spacing	l/h/m	Price €	Stock	Code	Spacing	l/h/m	Price €	Stock		
<b>Ø16 - 1.1 l/h</b>					<b>Ø16 - 2.3 l/h</b>						
09190460	20 cm	5.5	0.066	✗	09190068	20 cm	11.5	0.066	✗		
09190470	30 cm	3.7	0.066	✗	09190078	30 cm	7.5	0.066	✗		
09190480	40 cm	2.75	0.066	✗	09190088	40 cm	5.75	0.066	✗		
<b>Ø16 - 1.6 l/h</b>											
09190260	20 cm	8.0	0.066	✗							
09190270	30 cm	5.0	0.066	✗							
09190280	40 cm	4.0	0.066	✗							
<b>Ø16 - 2.3 l/h</b>											
09190060	20 cm	11.5	0.066	✗							
09190070	30 cm	7.5	0.066	✗							
09190080	40 cm	5.75	0.066	✗							

10 mil / 250 µm		2000 m/Reel	
Code	Type	Price €	Stock
-	PoliFlat Ø16 10 mil	0.073	✗

12 mil / 300 µm		1500 m/Reel	
Code	Type	Price €	Stock
-	PoliFlat Ø16 12 mil	0.080	✗

**Fittings and valves for drip tapes**

- Safe and fast way of connecting drip irrigation setup
- Easy assemble and reassemble, no tool or additional clamp required
- Assure additional protection even on uneven ground
- Specifically used for low-pressure connection



Find out more on page 53

Tape Fittings with ring



Find out more on page 55

Cylinder MINI Valves



Find out more on page 61

Cylinder Valves



Find out more on page 64



FIELD OF USE

- Orchards
- Vineyards
- Greenhouses with irregular plant spacing

On-line drippers used to be mounted on LDPE or Agriculture PE pipes from 16 mm and higher diameter. On-line drippers provide easy installation and are easily mounted by punching a 3 mm hole on the pipe. The minimum filtration capacity of the filter used in the system shall be 130 microns. Drippers are used with 7.0 x 4.0 mm microtube together with microtube fittings, except Medousa drippers, which are used with 5.0 x 3.0 mm microtube.

**Features**

- Ideal for trees and bushes.
- Easy cleaning
- High reliability, precision, and efficiency, minimizing clogging problems

Group 09320

**ON-LINE DRIPPER**



Code	Name	Bag	Box	Price €	Stock
● 09320030	Nestos 2 l/h	100	5000	0.124	✓
● 09320040	Nestos 4 l/h	100	5000	0.124	✓
● 09320050	Nestos 8 l/h	100	5000	0.124	✓

Group 09320

**ADJUSTABLE ON-LINE DRIPPER**



Code	Name	Bag	Box	Price €	Stock
● 09320020	70 l/h	100	5000	0.067	✓

Group 09330

**ON-LINE PC DRIPPER**



Code	Name	Bag	Box	Price €	Stock
● 09330010	Alfa mir 4 l/h	500	5000	0.143	✓
● 09330020	Alfa mir 8 l/h	500	5000	0.143	✓
● 09330040	Axios 2 l/h	100	4500	0.154	✓
● 09330060	Axios 4 l/h	100	4500	0.154	✓
● 09330100	Axios 8 l/h	100	4500	0.390	✓
● 09330070	Medousa 6x1 l/h	100	2500	0.154	✓
● 09330080	Medousa 6x2 l/h	100	2500	0.390	✓

Group 09330

**SUPERTIF ON-LINE PC DRIPPER**



Code	Name	Bag	Box	Price €	Stock
● 09330110	4 l/h	100	4000	0.217	✓

Group 09330 / 09390

**GALI ON-LINE PCND DRIPPER**



Code	Name	Bag	Box	Price €	Stock
● 09330120	2 l/h	100	8000	0.126	✓
● 09330130	4 l/h	100	8000	0.126	✓
● 09390050	1 - outlet adapter	1000	14 000	0.065	✓
● 09390060	2 - outlet adapter	1000	14 000	0.067	✓
● 09390070	4 - outlet adapter	1000	14 000	0.091	✓

Group 09330 / 09390

**SUPERTIF ON-LINE PCND DRIPPER**



Code	Name	Bag	Box	Price €	Stock
● 09330050	4 l/h	100	4000	0.217	✓
● 09330090	8 l/h	100	4000	0.217	✓
● 09390040	* 4-outlet adapter	5000	15 000	0.095	✓

\* This adapter also fits to Nestos, Axios and Alfa mir drippers

Group 09390

**SUPPORT SPIKES**



Code	Name	Bag	Box	Price €	Stock
● 09390010	For microtube	100	4000	0.072	✓
● 09390020	Flow Equalizing	1000	1000	0.060	✓
● 09390030	For microtube 5mm / red	100	4000	0.070	✓



## Sprinkler irrigation

Sprinkler irrigation is a method of applying irrigation water that is similar to natural rainfall. Water is distributed through a system of pipes usually by pumping. It is then sprayed into the air through sprinklers so that it breaks up into small water drops which fall to the ground.

### Features

- Land leveling is not required
- No loss of cultivable area due to channel construction
- Suitable for almost all soil types
- Water-saving irrigation intensity can change by the infiltration capacity of the soil and crop water requirements
- High efficiency due to uniform water distribution  
Water management can adapt to growth stage and conditions
- Possibility of irrigating for other purposes: sprouting, frost protection, or cooling during hot periods
- Lower labor requirements as compared to traditional surface irrigation approach

### Advantages

- Elimination of the channels for conveyance, therefore no conveyance loss
- Suitable to all types of soil except heavy clay
- Suitable for irrigating crops where the plant population per unit area is very high. It is most suitable for oilseeds and other cereal and vegetable crops
- Water saving
- Closer control of water application convenient for giving light and frequent irrigation and higher water application efficiency
- Increase in yield
- Mobility of system
- May also be used for undulating area
- Saves land as no bunds etc. are required
- Influences greater conducive micro-climate
- Areas located at a higher elevation than the source can be irrigated
- Possibility of using soluble fertilizers and chemicals
- Less problem of clogging of sprinkler nozzles due to sediment-laden water



### Impulse sprinklers

Impulse Sprinkler is a type of irrigation in which the sprinkler head is driven in a circular motion by the force of the outgoing water. The impulse sprinkler's long spray radius and uniform water distribution re-create the effect of natural rainfall.

- Impulse sprinkler
- Impulse sprinkler nozzles

#### Group 10040

#### IMPULSE SPRINKLER



Code	Size	Radius	l/min	Bag	Box	Price €	Stock
10040010	M1A 1/2" 2.7	8.0-9.8	4.7-7.2	5	300	3.49	✓
10040020	M1A 1/2" 3.0	8.5-9.5	7.0-10.0	5	250	3.49	✓
10040030	M1A 1/2" 4.0	9.0-10.0	10.5-15.5	5	250	3.49	✓
10040040	M1A 1/2" 5.0	9.5-10.0	15.5-22.0	5	250	3.49	✓
10040050	M2A 1/2" 2.3	8.0-9.0	4.7-7.2	5	350	3.60	✓
10040060	M2A 1/2" 3.0	8.5-9.5	7.0-10.0	5	350	3.60	✓
10040070	M2A 1/2" 4.0	9.0-10.0	10.5-15.5	5	350	3.60	✓
10040110	MPA 1/2" 2.7	8.0-9.0	4.7-7.2	5	250	4.93	✓
10040120	MPA 1/2" 3,0	8.5-9.5	7.0-10.0	5	250	4.93	✓
10040130	MPA 1/2" 4.0	9.0-10.0	10.5-15.5	5	250	4.93	✓
10040140	MPA 1/2" 5.0	9.5-10.0	15.5-22.0	5	250	4.93	✓
10040150	1" 4.5x2.5	12-14.5	21.7-34.0	-	50	7.19	✓
10040160	1" 5.5x4.0	12.5-16	31.0-56.7	-	50	7.19	✓
10040170	1" 6.5x4.0	13.5-16.5	40.0-74.0	-	50	7.19	✓
10040180	1" 8.0x4.0	14-18.5	54.0-100	-	50	7.19	✓

#### Group 10050

#### IMPULSE SPRINKLER NOZZLE



Code	Size	Radius	l/min	Bag	Box	Price €	Stock
10050010	1/2" ●	18.0-9.0	4.7-7.2	50	4500	0.134	✓
10050020	1/2" ●	9.0-10.0	10.5-15.5	50	4500	0.134	✓
10050030	1/2" ●	9.5-10.0	15.5-22.0	50	4500	0.134	✓
10050040	1/2" ●	8.5-9.5	37.0-10.0	50	4500	0.134	✓
10050050	1" ●	12-14.5	21.7-34.0	50	1700	0.360	✓
10050060	1" ●	13.5-16.5	40.0-74.0	50	1700	0.360	✓
10050070	1" ●	14-18.5	54.0-100	50	1700	0.360	✓
10050080	1" ●	12.5-16	31.0-56.7	50	1700	0.360	✓



Micro irrigation accessories

Different parts are necessary for the installation of microirrigation systems: Microirrigation adaptors and spikes, Sprinkler risers and spikes, Complete microsprinklers, Anti-drip device, etc.

Group 10510

**MICROTUBE END PLUG**



Code	Size	Bag	Box	Price €	Stock
10510160	7x4	25	5000 P2	0.057	✓

Group 10510

**MICROTUBE ADAPTOR FEMALE**



Code	Size	Bag	Box	Price €	Stock
10510150	7x4	25	5000 P2	0.079	✓

Group 10510

**MICROTUBE ADAPTOR MALE**



Code	Size	Bag	Box	Price €	Stock
10510140	7x4	25	20 000 P2	0.057	✓

Group 10510

**MICROIRRIGATION ADAPTOR**



Code	Description	Bag	Box	Price €	Stock
• 10510010	Adaptor F 6	100	20 000	0.035	✓
10510060	Adaptor F 7	100	5000 P1	0.080	✓
• 10510030	Adaptor F 8	100	10 000	0.083	✓
• 10510040	Adaptor M 6	100	25 000	0.030	✓
• 10510020	Connector 6x12 PE	100	10 000	0.058	✓
10510050	Adaptor M 7	100	5000 P1	0.080	✓
• 10510090	Joint 8 mm	100	5000	0.052	✓
• 10510100	End plug 6	100	45 000	0.035	✓
• 10510110	End plug 8	100	30 000	0.058	✓
10510130	End plug F 7	100	5000 P1	0.080	✓

Group 10520

**MICROIRRIGATION SPIKE**



Code	Description	Bag	Box	Price €	Stock
• 10520010	8 mm 40 cm black	100	500	0.286	✓
• 10520020	8 mm 50 cm black	-	200	0.662	✓
10520030	30 cm	-	400 P3	0.196	✓

Group 10530

**SPRINKLER SPIKES**



Code	Size	Bag	Box	Price €	Stock
• 10530010	1/2x20	10	250	1.09	✓
• 10530020	1/2x3/4"	10	350	0.799	✓

Group 10540

**SPRINKLER RISER**



Code	Size	Bag	Box	Price €	Stock
• 10540050	1/2" 80 cm	1	30	2.51	✓
10540060	1" 40 cm	-	10	1.21	✓
10540070	1" 60 cm	-	10	1.51	✓
10540080	1" 80 cm	-	10	1.81	✓
10540090	1" 100 cm	-	10	2.11	✓
10540100	1" 120 cm	-	10	2.54	✓
10540110	1" 140 cm	-	10	2.71	✓
10540120	1" 200 cm	-	10	3.01	✓
• 10540130	3/4x1/2" 30 cm	-	180	1.72	✓
• 10540140	3/4" 30 cm	-	150	1.72	✓
• 10540160	1" 50 cm	-	100	1.94	✓
• 10540170	1/2" M/F	-	350	1.37	✓

Group 10180

**COMPLETE MICROSPRINKLER**



Code	Name	Bag	Box	Price €	Stock
• 10180010	90°	10	150	5.19	✓
• 10180020	180°	10	150	5.19	✓
• 10180500	Riser	10	300	2.23	✓
• 10180510	Spike	100	1800	0.452	✓



Microsprinklers

Microsprinkler irrigation saves water because of the high application efficiency and high-water distribution uniformity with small waste. Microsprinklers and microsprayers provide low precipitation rates, allowing longer watering time. Field of applications: nursery, greenhouses, orchards, and vegetables.

Group 10140

**DELTA SPRINKLER**



Code	Color	Radius	I/h	Bag	Box	Price €	Stock
10140010	●	5	160	100	2000	0.267	✓
10140020	○	5.75	250	100	2000	0.267	✓
10140030	●	5.5	300	100	2000	0.267	✓
10140040	●	4.5	120	100	2000	0.267	✓
10140050	●	4.75	140	100	2000	0.267	✓
10140060	●	5	200	100	2000	0.267	✓

Group 10150

**SUPER SPRINKLER**



Code	Color	Radius	I/h	Bag	Box	Price €	Stock
10150010	○	4.75	300	100	4000	0.154	✓
10150020	●	3.5	70	100	4000	0.154	✓
10150030	●	2.5	40	100	4000	0.154	✓
10150040	●	4.75	300	100	4000	0.154	✓
10150050	●	4	120	100	4000	0.154	✓
10150060	●	4.5	200	100	4000	0.154	✓
10150070	●	4	105	100	4000	0.154	✓
10150080	●	3.75	90	100	4000	0.154	✓

Group 10160

**FOGGER**



Code	Size	Radius	I/h	Bag	Box	Price €	Stock
10160010	6	-	7	-	100	2.72	✓
10160020	4x6	-	4x7	-	100	6.37	✓

Group 10170

**BUBBLERS**



Code	Name	Bag	Price €	Stock
10170010	0 - 60 l/h adjustable	25	0.731	✓
10170100	PC 40 l/h	25	1.34	✓



# Garden

---

Garden irrigation is a watering system that is used in residential and commercial landscaping. The primary function of a garden and landscape irrigation system is to ensure that water is spread regularly and evenly throughout any given landscape.





## Valve boxes

The Valve box is specifically designed to create a safe and secure environment for the valves, fittings, wires, and manifolds, in other words, the components of an irrigation system. It protects against vandalism, the elements, and damage due to mowers, string trimmers.

### Features

- Easy access to buried irrigation control valves
- Protects essential components of your irrigation system
- Durable Construction
- Lightweight and easy handling
- Fast, trouble-free, and cost-saving installations

### Specifications and Technical data

Type	<ul style="list-style-type: none"> <li>• Rectangular valve box</li> <li>• Circular valve box</li> <li>• Valve box with 3/4" valve</li> <li>• Valve box cover</li> <li>• Valve box rack</li> </ul>
Field of use	<ul style="list-style-type: none"> <li>• Residential</li> <li>• Agriculture</li> <li>• Sports irrigation systems</li> </ul>
Materials	Body - Black UV stabilized polypropylen Cover - Green UV stabilized polypropylen Screw - Galvanized steel
Color	• Black body, Green lid
Size	(Mini) 6", (Standard) 12", (Large) 10", Jumbo, Super Jumbo
Standard	EN 124



Antivandalisme  
screw option

Material: 100% Polypropylene  
 Classification: UNI EN 124 A class A 15 (Peak load > 15 Kn)



Group 15010

**POLIEXT RECTANGULAR**

Code	Name	Size	Pallet	Box	Price €	Stock
15010210	Standard	525x395x330	144	1	16.80	✓
15010220	Jumbo	385x555x330	96	1	27.94	✓
15010230	Super Jumbo	370x590x415	44	1	64.44	✗

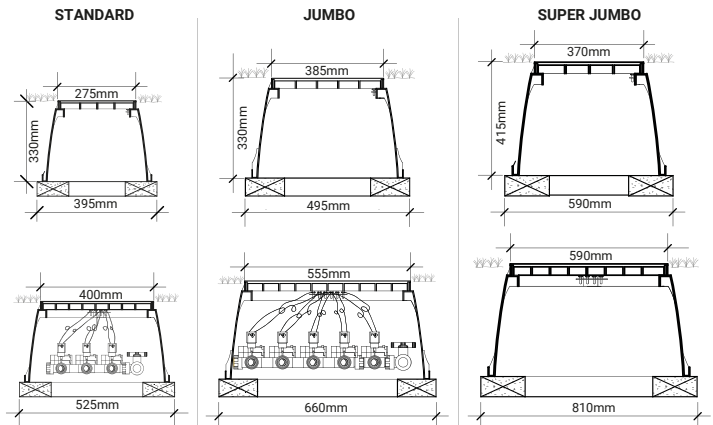

Group 15020

**POLIEXT CIRCULAR**

Code	Name	Size	Pallet	Box	Price €	Stock
15020210	Mini	152x229	792	1	3.34	✓
15020220	Large	253x261	396	1	5.67	✓

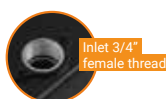
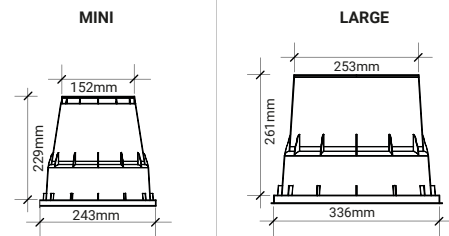

Group 15030

**POLIEXT WITH 3/4" VALVE**

Code	Name	Size	Pallet	Box	Price €	Stock
15030030	with valve	3/4"	288	18	15.14	✓

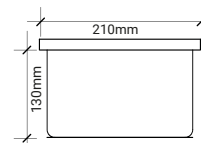

Group 15060

**POLIEXT RACK**



Code	Name	Pallet	Box	Price €	Stock
15060010	Standard +1" Hanger (4 pcs)	-	1	8.33	✓
15060020	Jumbo +1" Hanger (6 pcs)	-	1	10.03	✓
15060110	Hanger for rack 1" (8 pcs)	-	1	4.62	✗
15060120	Hanger for rack 6/4" (8 pcs)	-	1	5.39	✗
15060130	Hanger for rack 2" (8 pcs)	-	1	6.30	✗

Group 15050

**POLIEXT BOX COVER**



Code	Name	Pallet	Box	Price €	Stock
15050110	Mini	-	1	2.20	✓
15050120	Large	-	1	2.38	✓
15050130	Standard	-	1	5.39	✓
15050140	Jumbo	-	1	9.24	✓



Anti-vandal locking system

Group 15010

**RECTANGULAR**

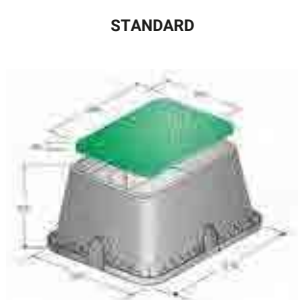

STANDARD

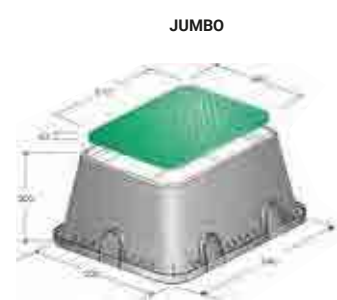

JUMBO

Code	Name	Pallet	Box	Price €	Stock
15010010	Standard 12"	168	1	16.21	✓
15010020	Jumbo	112	1	27.86	✓

Group 15030

**WITH 3/4" VALVE**

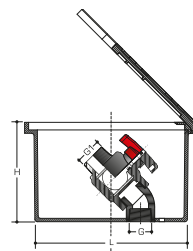

Code	Name	Pallet	Box	Price €	Stock
15030010	Open cover	-	18	19.05	✓
15030020	Closed cover	-	18	19.05	✓

Group 15050

**BOX COVER**



Code	Name	Pallet	Box	Price €	Stock
15050010	Mini 6"	-	25	2.22	✓
15050020	Circular 10"	-	20	2.36	✓
15050030	Standard 12"	-	10	5.97	✓
15050040	Jumbo	-	6	10.24	✓

Group 15040

**RISER**



Code	Name	Pallet	Box	Price €	Stock
15040010	Standard	96	1	13.85	✓
15040020	Jumbo	72	1	19.90	✓



## Plastic Grass Grid

A modern and stable solution for covering the ground in both domestic and commercial applications. It strengthens the soil, protecting against erosion. Plastic grids provide exceptional ground reinforcement as well as water drainage in a variety of applications. It does not crack, it is permeable, and will not dry out grass or cause flooding.

### Features

- Form and size allows for independent installation
- Can be set up easily, its setting up does not need any special instrument
- Durable, eco friendly, and easy maintenance
- Its environment protective material is UV and heat resistant
- Unique interlocking click system

### Application

- Driveway grids & gravel parking
- Grass or gravel car parks
- Driveways and residential lawn
- Grass stabilization
- Lawn protection

### Filling

- Soil
- Grass seed
- Gravel
- Stones

## Installation Guide for gravel filling

<p>Form the shape of the area using a rope. Take out the soil to the appropriate depth and level the the base keeping a 1.5% slope.</p>	<p>Position a geotextile to prevent the mixing of layers and support the substructure.</p>	<p>Apply the self-binding aggregate and compress it mechanically.</p>	<p>Apply a base layer and even out with a traversing rule.</p>
<p>Begin in the corner and install grids in rows. Keep a minimum 5 cm gap between the edge and grid cover. The locking system indicates the installation direction.</p>	<p>Merge the grids with the locking system and press down strongly (use a foot or rubber mallet). If required, cut the grids with an angle grinder or a blade to fit.</p>	<p>Level out the grid surface using a compactor or a garden roller.</p>	<p>Fill the grids with the gravel and compress it mechanically.</p>

### IMPORTANT:

The technical description is not specific! Please, contact us before installation.

### NOTE:

When filling with stones, it is recommended to place the geotextile under the turf to prevent weed growth.



## Grass Saver Raster

Grass Saver Raster is a plastic covering element that can be connected. Modern, stable floor grids for those who are looking for an alternative to concrete or asphalt for their property or public areas. This is a particularly individual form of floor fastening that is used in many different everyday applications - Parking spaces, Logistics & Storage space, Erosion control, Driveways & Paths, Home & Garden, Forest & Agriculture and Equestrian sports.

Group 13010

### GRASS SAVER RASTER

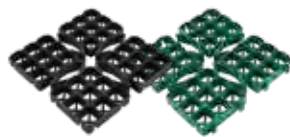

Code	Name	Pallet	Price €	Stock
13010010	Black	282	7.63	✓
13010020	Green	282	11.49	✓

Group 13020

### MARKER FOR GRASS SAVER RASTER



Code	Name	Box	Price €	Stock
13020010	Black or white	80 P1	1.05	✓

#### Specifications and Technical data

Outer Size:	480 x 480 x 48 mm
Weight:	7,5 kg/m <sup>2</sup>
Material:	100% Polyethylene that can be recycled
Weight capacity:	Filled with soil – 1500 kN/m <sup>2</sup> , 150 t/m <sup>2</sup>
	Not filled – 1000 kN/m <sup>2</sup> , 100 t/m

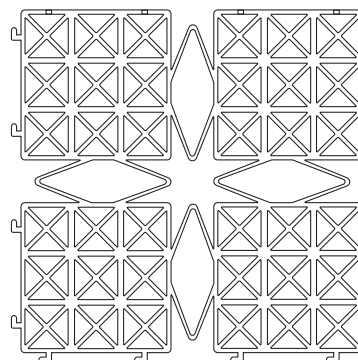

### SUBSTRUCTURE LAYERS

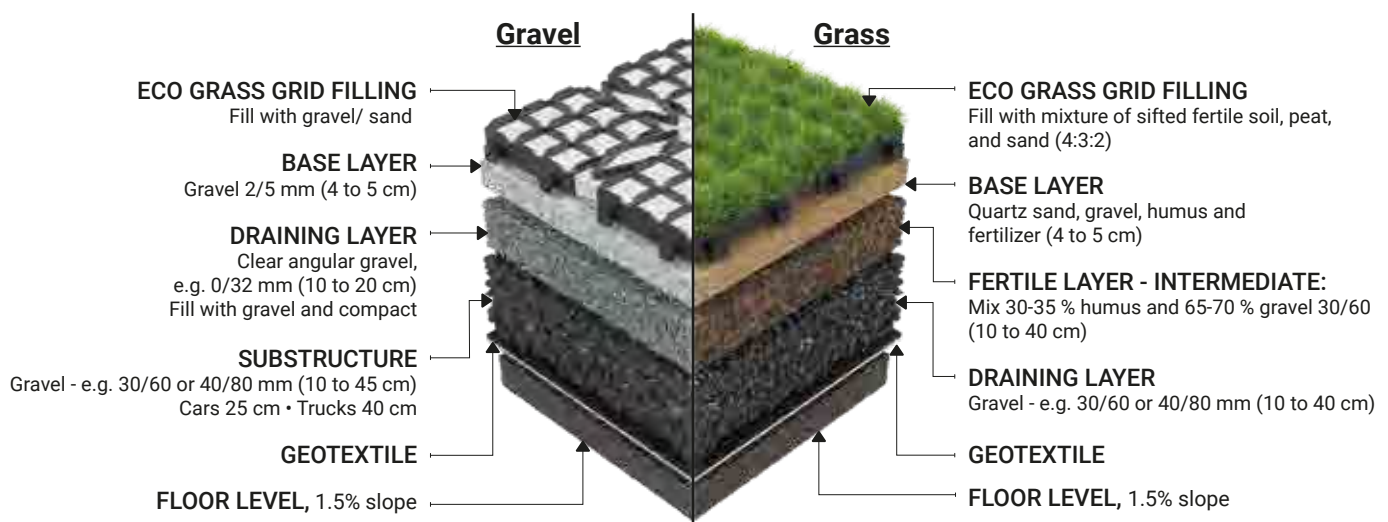



## SOON Eco Grass Grid

**Material:** 100% polyethylene that can be recycled

**Contact surface area:** 3400 cm<sup>2</sup>/m<sup>2</sup>

The Eco Grass Grid can be filled with soil and grassed as the cell structure and open base promotes unrestricted root growth. The Eco Grass Grid can also be filled with gravel providing a high-quality decorative look. The cell structure retains the gravel and prevents loss or gravel displacements. Perfect for laying strengthened new lawns, just interlock the grids, fill with soil and sow the seeds.

### ECO Grass Grid T50-5

Height - 50 mm

Code	Size (LxWxH)	Wall Thickness
13010030	500x500x50	5 mm

### ECO Grass Grid T50-4

Height - 50 mm

Code	Size (LxWxH)	Wall Thickness
13010040	500x500x50	4 mm

#### Features

- Made from 100% recycled materials
- UV stable / resistant
- Easy to install
- Pre-assembled EcoRasters can be taken directly off pallets, in layers, and easily be laid on the ground
- Fixing points for connecting to the ground
- T-shaped locking system provides firm and secure connection

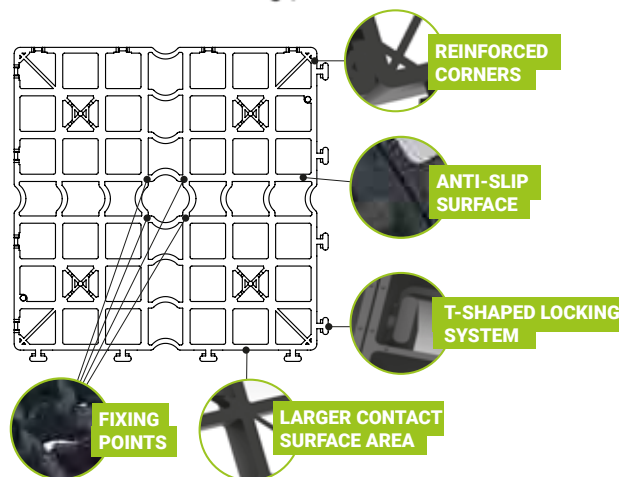

### SUBSTRUCTURE LAYERS

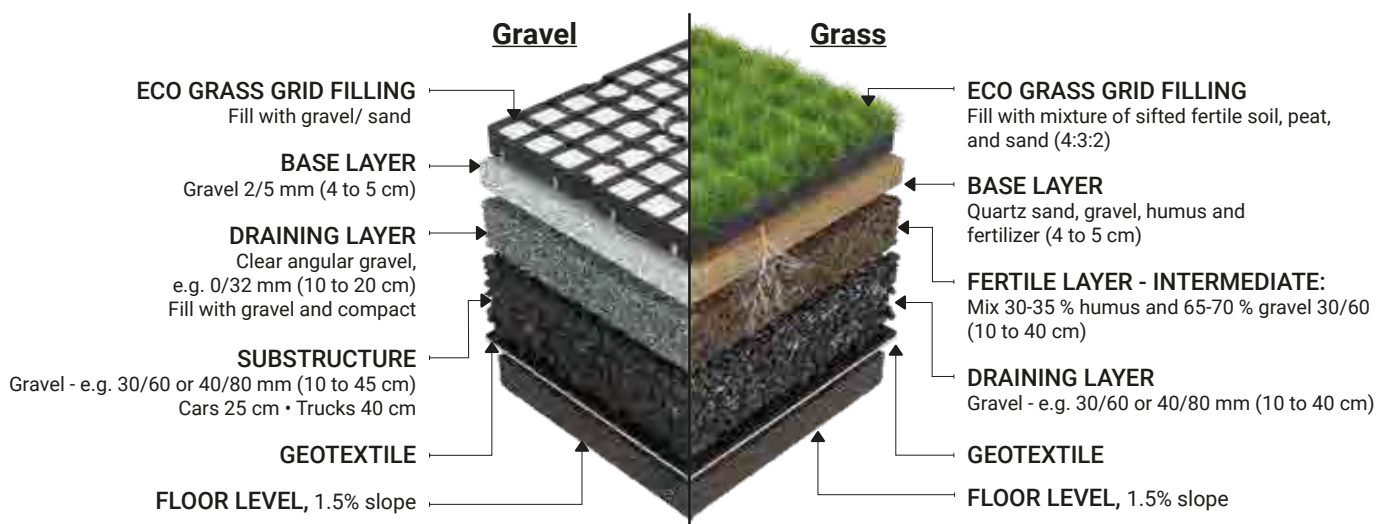



## Living Green wall

Prefabricated panels with pots for forming amazing green walls. By simply setting the sets from our offer, with a little creativity, you can easily have a unique look on your walls. We offer a larger and smaller set of amazing LIVING GREEN WALLS.

- Minimal effort of placing and removing pots
- Simple maintenance - irrigation from the top is completely satisfying
- Beautiful visual experience

Group 23010 **NEW**

### GREEN WALL - SOIL PLANTING



Code	Name	Pallet	Price €	Stock
23010010	5" set (5 pots)	120	19.20	✓
23010030	8" set (3 pots)	105	23.40	✓

• Each set contains pots, pipes, divider & non-woven wrap and frame with a bag of mounting accessories.  
• Pallet dimensions: 80x120x240

Group 23010 **NEW**

### GREEN WALL - HYDRO CULTURE



Code	Name	Price €	Stock
23010020	5" (hydro culture) 5 pot set	24.60	✗

• Each set contains pots, pipes, divider & holder and frame with a bag of mounting accessories.  
ONLY ON REQUEST / DO NOT KEEP ON STOCK

#### Specifications and Technical data

Material	Polypropilene (PP)
Color	Black
UV stable	✓
Heat resistance	✓
Chemicals resistance	✓

#### 5 pot set (small) - Soil Planting



Panel WxH: 16x80cm  
Pot LxWxH: 20x15x11cm  
Pot reservoir: 150cc  
Pot volume: 1000cc  
Set weigh (with plants): 8-13kg

8 sets ~ 1m<sup>2</sup>

#### 3 pot set (large) - Soil Planting



Panel WxH: 26x80cm  
Pot LxWxH: 30x24x21cm  
Pot reservoir: 700cc  
Pot volume: 8000cc  
Set weigh (with plants): 21-25kg

5 sets ~ 1m<sup>2</sup>

#### Features

- Frames click together in multiple orientations
- Adjustable frames up to 90 degrees
- Built-in reservoir overflow system in each pot
- Simple to install
- Light yet sturdy construction
- Good drainage
- Automatic irrigation system
- Economical water consumption and no waste
- Space-saving
- Interchangeable plant pots



0-90°

Modular



## BLOCKAGE FREE DRAINAGE

### Built-in reservoir overflow system

Poliext Green Walls are a revolutionary modular solution, with a built-in **Flow Through** and **Overflow reservoir** system in each pot, preventing overwatering of the plant and root rotting.

- The Flow Through system** - Water drips on the topmost row and moves down to each succeeding row to ensure all plants are appropriately watered.
- The Overflow Reservoir system** - collects excess water. Excess water flows through the openings in the bottom of the pot.

Our recommendation is not to close the openings at the bottom of the pot because excess water drains through the openings preserving the plant healthy.

All you need to do is water the top planter, and excess water automatically makes its way down to the lower planting pots.

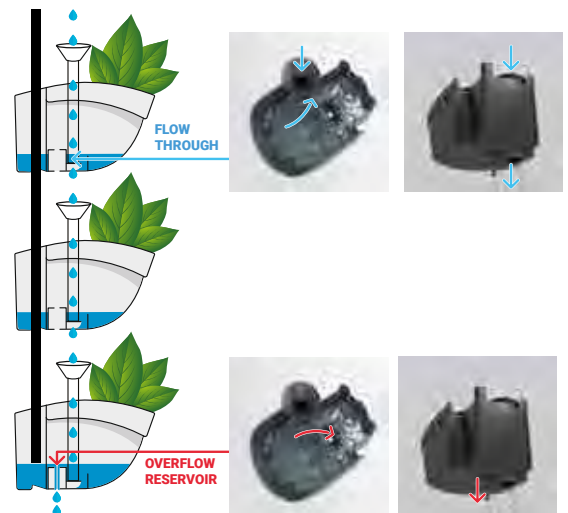

## Installation Guide

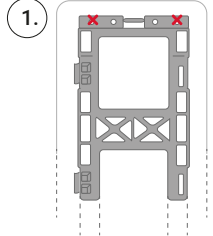
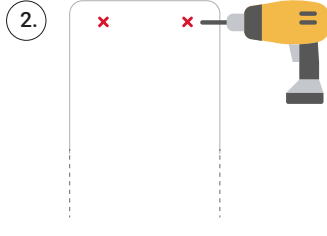
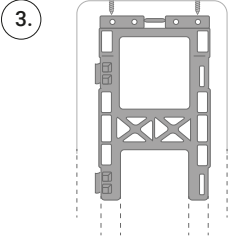
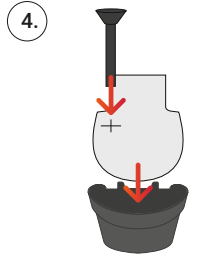
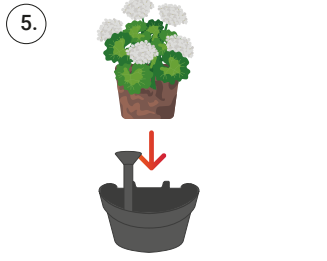
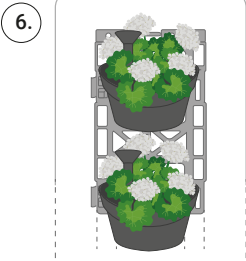
-  1. Position the panel and mark mounting holes
-  2. Drill holes
-  3. Attach the frame with screws and dowels
-  4. First, place the tube through the pot liner, and put them together into the pot
-  5. Add plants to pots
-  6. Hang the pots on the frame

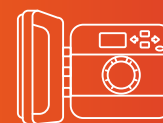

## Water Timing & Control

Add an irrigation timer for even more convenience. Poliext offers easy to operate and very reliable irrigation timers.

### IMPORTANT

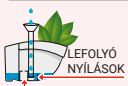

Do not seal the holes at the bottom of the pot. Sealing holes blocks water drainage and can lead to root rotting.



When adding soil to the pots, make sure it doesn't get into the irrigation pipes.

### NOTE

Please check the bearing capacity of the surface you are mounting the Living Green Wall, according to the weight of the pots when they are full. When covering larger areas with the Living Green Wall modules substructure is necessary.

Place drip tray for excess water accumulation and drainage under the Green Wall panels, especially for indoor installations.

For the best results, please, consult your horticulture specialists.



## Heliflex home garden

To make your garden flowers happy give them water with pipes and hoses from Heliflex.

Heliflex, when your house and garden are our concern!

Group 01600

### GARDEN HOSE 3-LAYERS



Code	Size	PN	Package	Price €	Stock
01600010	1/2"	8 bar	25	0.800	✓
01600020	1/2"	8 bar	50	0.800	✓
01600030	3/4"	8 bar	25	1.45	✓
01600040	3/4"	8 bar	50	1.45	✓



Group 01600

### GARDEN HOSE 5-LAYERS



Code	Size	PN	Package	Price €	Stock
01600110	1/2"	20 bar	25	1.21	✓
01600120	1/2"	20 bar	50	1.21	✓
01600130	3/4"	20 bar	25	1.94	✓
01600140	3/4"	20 bar	50	1.94	✓

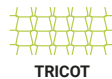

Group 20100

### THREADED TAP CONNECTOR



Code	Size	Bag	Box	Price €	Stock
20100070	1/2" - 1"	1	40	1.38	✓

Group 20100

### AQUASTOP HOSE END CONNECTOR



Code	Size	Bag	Box	Price €	Stock
20100140	1/2"	1	40	1.49	✓
20100150	3/4"	1	40	1.68	✓

Group 20100

### HOSE REPAIR CONNECTOR



Code	Size	Bag	Box	Price €	Stock
20100120	1/2"	1	40	1.35	✓
20100130	3/4"	1	40	1.40	✓

Group 20100

### HOSE END CONNECTOR



Code	Size	Bag	Box	Price €	Stock
20100010	1/2"	1	40	1.43	✓
20100030	3/4"	1	40	1.56	✓

Group 20100  
**Y CONNECTOR**



Code	Bag	Box	Price €	Stock
20100040	-	350	2.26	✓

Group 20100  
**HOSE NOZZLE**



Code	Bag	Box	Price €	Stock
20100060	1	60	1.83	✓

Group 20100  
**MULTI-PURPOSE SPRAY GUN**



Code	Bag	Box	Price €	Stock
20100170	1	24	5.78	✓

Group 20100  
**WATERING STARTER SET**



Code	Size	Bag	Box	Price €	Stock
20100180	1/2"	1	45	6.02	✓
20100190	3/4"	1	45	6.38	✓

Group 20100  
**HOSE WINDING**



Code	Package	Price €	Stock
20100200	1	35.81	✓

Group 20100  
**HOSE HANGER**



Code	Package	Price €	Stock
20100210	40	3.66	✓

Group 12010  
**SIMPLE WATER TIMER (LCD-1)**



Code	Bag	Box	Price €	Stock
12010080	1	27	59.38	✓

Group 20100  
**M / M CONNECTOR**



Code	Bag	Box	Price €	Stock
20100050	-	500	0.688	✓

Group 20100  
**SPRAY GUN**



Code	Bag	Box	Price €	Stock
20100110	1	36	5.62	✓

Group 20100  
**PROFESSIONAL SPRAY GUN**



Code	Bag	Box	Price €	Stock
20100160	1	24	12.19	✓

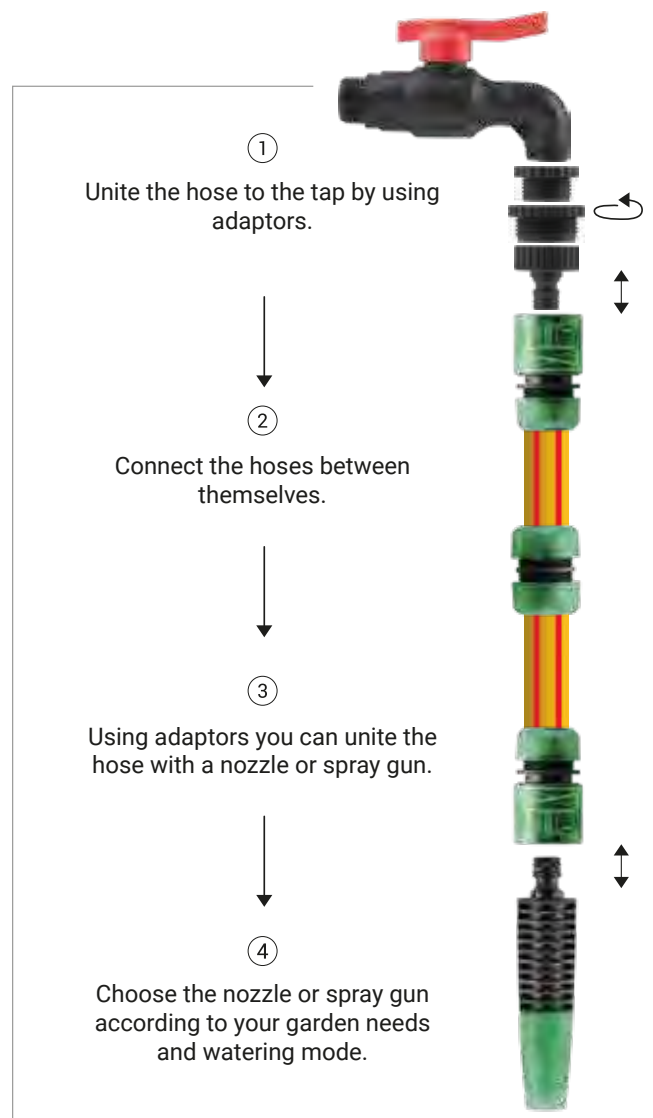

# Other

---

Without proper tools and equipment irrigation system would not function properly. Polixt offers a range of specialized irrigation tools, equipment, and accessories to help you do the job right.

Our products will support you to install, maintain and repair irrigation system a whole lot easier.





## Equipment

Different equipment available depending on the kind of system and the type of installation. Often, installations have a similar structure, so most additional irrigation requirements can be solved with a relatively small range of equipment – ground hooks, supporting hooks, support zip-tie, silicon wire connection, PVC tying string, marking table, rubber sealing rings, etc.

Group 20020

### WATER STOP SUPPORTING HOOK



Code	Size	Bag	Box	Price €	Stock
20020015	16	50	5500 P3	0.040	✓
20020025	20	50	3000 P3	0.072	✓
20020035	25	50	2000 P3	0.100	✓
20020045	32	50	1000 P3	0.144	✓

Group 20020

### SUPPORTING HOOK



Code	Size	Bag	Box	Price €	Stock
• 20020010	16	100	4500 P3	0.035	✓
• 20020020	20	100	4000 P3	0.059	✓
• 20020030	25	100	2400 P3	0.082	✓
• 20020040	32	100	1200 P3	0.111	✓

Group 20010

### GROUND HOOK



Code	Size	Bag	Box	Price €	Stock
20010010	16 - 20 mm Black	100	800 P3	0.110	✓
20010030	16 - 20 mm Brown	100	800 P3	0.130	✓

Group 09390

### SUPPORT ZIP-TIE



Code	Size	Bag	Box	Price €	Stock
09390100	5 - 23 mm	500	5000 P2	0.034	✓

Group 20060

### MARKING TABLE



Code	Size	Bag	Box	Price €	Stock
20060010	83x53 mm	25	300 P1	0.267	✓

Group 20050

### PVC TYING STRING



Code	Size	Bag	Box	Price €	Stock
• 20050020	1 kg (kb.200 m)	-	15	3.05	✓

Group 20030

### SILICON WIRE CONNECTOR 3M



Code	Size	Bag	Box	Price €	Stock
• 20030010	3 x 1.5	30	300	0.859	✓

Group 17020

### GREENHOUSE CLIP



Code	Size	Bag	Box	Price €	Stock
• 17020010	Metal 1/2"	-	2890 P3	0.147	✓
• 17020020	Metal 3/4"	-	1670 P3	0.264	✓
• 17020030	Metal 1"	-	1470 P3	0.292	✓
• 17020040	Metal 5/4"	-	940 P3	0.341	✓
• 17020050	Metal 6/4"	-	670 P3	0.464	✓
• 17020060	Metal 2"	-	330 P3	0.905	✓
• 17020070	Plastic 15 cm 1/2" (super)	-	400	0.286	✓
• 17020080	Plastic 15 cm 3/4" (super)	-	1600	0.422	✓
• 17020090	Plastic 15 cm 1" (super)	-	200	0.525	✓



## Tools and Accessories

The necessary parts and accessories to enhance irrigation system installation for home irrigation systems or commercial settings are also available. Range of convenient tools and auxiliary items for irrigation systems that save time and make jobs easier.

### Group 14020

#### PUNCH & DRILL



Code	Name	Box	Price €	Stock
14020010	Punch for dripper	1	1.86	✓
14020080	Scissor Punch 16-20	100	29.04	✓
14020090	Scissor Punch 25-32	1	35.74	✓
14020100	Punch 3 mm Green	200	2.41	✓
14020110	Layflat hose puncher	1	206.60	✓

### Group 14040

#### CHAMFERING TOOL



Code	Size	Box	Price €	Stock
14040020	20 - 63 mm	55 P1	27.20	✓
14040030	75 - 110 mm	1	94.00	✓
14040110	Spare blade	10	3.41	✓

### Group 14060

#### SEALING MATERIAL



Code	Name	Bag	Box	Price €	Stock
14060010	Liquid teflon	-	100	2.38	✓
14060020	Teflon tape 0.075mm x 12m	10	250	0.449	✓
14060030	Teflon tape Gas 0.1mm x 10m	10	200	0.496	✓

### Group 20210

#### PE PIPE SPACER 110



Code	Size	Bag	Box	Price €	Stock
20210020	110/8	-	40 P4	2.99	✓

### Group 14030

#### PIPE SCISSOR



Code	Size	Box	Price €	Stock
14030010	up to 40 mm	1	12.39	✓

### Group 14050

#### WRENCH



Code	Size	Bag	Box	Price €	Stock
14050010	32 - 63 mm	-	1	9.39	✓
14050020	75 - 125 mm	-	1	13.93	✓

### Group 14070

#### MANOMETER



Code	Size	Bag	Box	Price €	Stock
14070010	1/4"	-	100	7.60	✓
14070020	1/4" Glycerine	-	100	18.77	✓
14070030	Bas snap	100	5500	0.616	✓
14070040	Needle	100	5000	0.149	✓

### Group 20220

#### DUCT COUPLING 110



Code	Size	Bag	Box	Price €	Stock
20220040	110x110	12	1	1.83	✓

#### NOTE

- We produce PE Protection Duct also on special request, custom branded and in different colors and lengths.



## Polyduct shafts and tanks

A professional drinking water network and wastewater treatment system includes the collection, drainage, treatment and treatment of drinking water and wastewater. Our company offers solutions for all this, regardless of whether the system supplies individual households, residential communities, industrial facilities and settlements.

### Group 21010

#### UNDERGROUND TANKS



Code	Name	Price €	Stock
21010010	Lying cylindrical 2500 l	On Request	✓
21010030	Standing cylindrical 3000 l	On Request	✓
21010040	Standing cylindrical 5000 l	On Request	✗
21010050	Lying cylindrical 5000 l natur	On Request	✗
21010060	Lying cylindrical 5000 l	On Request	✓
21010070	Lying cylindrical 7500 l	On Request	✓

### Group 21020

#### PUMP SHAFTS



Code	Name	Price €	Stock
21020030	1000mm	On Request	✓

### Group 21040

#### WASTEWATER NETWORK SHAFTS



Code	Name	Price €	Stock
21040010	WILO 1500mm	On Request	✗

### Group 21020

#### WATER METER SHAFTS



Code	Name	Price €	Stock
21020010	Climbable 1200mm	On Request	✓
21020020	Climbable 1400mm	On Request	✓
21020110	Surface-close 1200mm	On Request	✗

### Group 21030

#### COMPOST BIN



Code	Name	Price €	Stock
21030010	Black 300 l	On Request	✓
21030020	Green 400 l	On Request	✓
21030030	Green 1000 l	On Request	✗

A wide range of parts is available for the products (rubber rings, manhole cover, etc.).



## DIY - Do It Yourself

The Poliext DIY program includes everything for successful gardening. Our watering systems take the trouble out of watering and make the easiest way to give plants the consistent moisture they need.

We deliver the performance and effectiveness of professional drip irrigation to home gardens!

### Group 01015

#### PE DRINK-WATER PIPES PE100 - SMALL PACKAGE

##### SDR 11- PN16

Code	Type	Pack.	Pallet	Price €	Stock
<b>Ø20 x 2.0 mm</b>					
01015038	Rod	2	3000	0.934	✗
01015021	Coil	5	88	0.819	✗
01015022	Coil	10	52	0.780	✗
01015023	Coil	25	36	0.742	✗
<b>Ø25 x 2.3 mm</b>					
01015078	Rod	2	2 465	1.26	✗
01015061	Coil	5	80	1.20	✗
01015062	Coil	10	44	1.15	✗
01015063	Coil	25	28	1.10	✗

Code	Type	Pack.	Pallet	Price €	Stock
<b>Ø32 x 3.0 mm</b>					
01015118	Rod	2	1485	2.06	✗
01015101	Coil	5	56	1.95	✗
01015102	Coil	10	32	1.87	✗
01015103	Coil	25	24	1.77	✗
<b>Ø40 x 3.7 mm</b>					
01015178	Rod	2	954	3.44	✗
01015161	Coil	5	26	3.01	✗
01015162	Coil	10	16	2.88	✗
01015163	Coil	25	10	2.74	✗

Pallet dimension (LxWxH): 5, 10, 25 m - 130x110x130 cm  
2 m - 200x110x130 cm



### Group 09100

#### POLIDRIP NON-PC - SMALL PACKAGE

##### Ø16 mm

##### 25 m Roll

Code	Spacing	Pallet	Price €	Stock
<b>2 l/h</b>				
09100061	33 cm	65	0.379	✗

##### Ø16 mm

##### 50 m Roll

Code	Spacing	Pallet	Price €	Stock
<b>2.0 l/h</b>				
09110262	33 cm	32	0.361	✗



### Group 09200

#### POLITAPE DRIP TAPE - SMALL REELS

Operating pressure: 0.7 - 1.0 bar

##### 6 mil / 150 µm

##### 100 m/Reel

Code	Spacing/Flow	Price €	Stock
<b>Ø16 - 0.6 l/h/emitter</b>			
09200011	10cm 6.0 l/h/m	0.109	✓
09200021	20 cm 3.0 l/h/m	0.109	✓
<b>Ø16 - 1.0 l/h/emitter</b>			
09200111	10cm 10.0 l/h/m	0.109	✓
09200121	20cm 5.0 l/h/m	0.109	✓

##### 6 mil / 150 µm

##### 500 m/Reel

Code	Spacing/Flow	Price €	Stock
<b>Ø16 - 0.6 l/h/emitter</b>			
09200015	10cm 6.0 l/h/m	0.088	✓
09200025	20cm 3.0 l/h/m	0.088	✓
<b>Ø16 - 1.0 l/h/emitter</b>			
09200115	10cm 10.0 l/h/m	0.088	✓
09200125	20cm 5.0 l/h/m	0.088	✓





Group 09300

**GARDEN DRIP IRRIGATION KIT**

Code	Size	Pallet	Price €	Stock
09300011	up to 75 m <sup>2</sup>	24	66.41	✓

Pallet dimension (LxWxH): 120x80x130 cm

Irrigation set intended for setting the irrigation system in hor gardens.



FIELD OF USE

- Orchards
- Vineyards
- Greenhouses
- Trees
- Bushes

Garden Drip Irrigation Kit includes

						
Drip-line d16, 2 l/h, 33 cm - <b>50 m</b>	LDPE pipe 16x1.2 mm - <b>20 m</b>	Cylinder MINI valve Barbed F 16x1/2" - <b>x5</b>	Barbed Male Tee 16x1/2"x16 - <b>x4</b>	Barbed Male Elbow 16x1/2" - <b>x1</b>	Barbed End plug 16 - <b>x5</b>	Teflon tape 0.1 mmx10 m - <b>x1</b>

Group 09300

**VEGETABLE DRIP IRRIGATION KIT**

Code	Size	Pallet	Price €	Stock
09300110	up to 50 m <sup>2</sup>	280	43.51	✓

Irrigation set intended for setting the irrigation system especly for SHORT - TERM cultured plantation.











FIELD OF USE

- Annual and biennial plants
- Vegetable
- Berries
- Greenhouses
- Growing ornamental plants

Vegetable Drip Irrigation Kit includes

				
Politape 6 (6 mil 6 l/h 10 cm) - <b>100 m</b>	Cylinder MINI valve Offtake (14 mm) 17 - <b>x10</b>	Tape Coupling 17x17 - <b>x5</b>	Tape End plug 17 - <b>x10</b>	Drill bit Ø14 mm - <b>x1</b>

Water supply setup NOT INCLUDED in drip irrigation kits

							
Garden Valve PN16 3/4" x 3/4"	Hose End connector 3/4"	Tap connector Female 1/2"-1"	Garden Hose 3/4"	Screen Filter 1" 120 mesh	Reduction FM (enlarging) 1 x 3/4"	Pressure regulator (white) 3/4"	

Following parts are required for connecting Irrigation kit with water supply setup

<b>Garden Drip Irrigation Kit</b>			
	1 PP Female Adaptor 16 x 3/4" PN10	PP End plug 16 PN10	
<b>Vegetable Drip Irrigation Kit</b>			
	1 PP Female Adaptor 16 x 3/4" PN10	LDPE pipe 16 x 1.2mm	PP End plug 16 PN10

Group 23010

**LIVING GREEN WALL DIY SET** NEW

Code	Size	Pallet	Price €	Stock
23010040	16x80cm	24	On Request	✓

Pallet dimension (LxWxH): 120x80x130 cm

Living Green Wall DIY set with drip irrigation is perfect for vertical planting and small areas

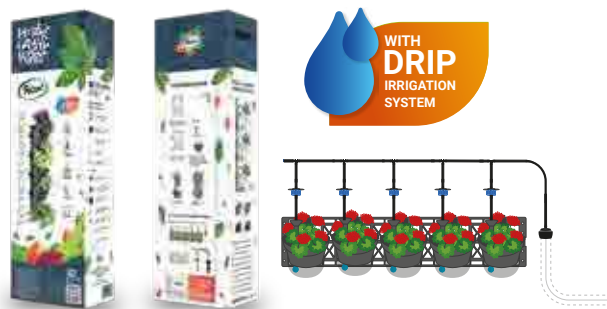

**LIVING GREEN WALL DIY SET includes**

				
Frame 16x80 cm - <b>x1</b>	Pots 20x15x11 cm - <b>x5</b>	Non-woven Pot Liners - <b>x5</b>	Pipes - <b>x5</b>	Dowels and screws - <b>x4</b>
				
Microtube 4.0x1.5 mm - <b>5m</b>	Nipple 3/4"x3/4" - <b>x1</b>	3/4" Female nut/Washer x 4,5 mm Barbed - <b>x1</b>	Barbed T coupling 5x5x5 - <b>x5</b>	On-line PC dripper Axios 8 l/h - <b>x5</b>
				
				Barbed End plug 4 - <b>x1</b>

**BOX P1**

Box dim. (LxWxH): 40x20x30 cm  
 Box volume: 0.024 m<sup>3</sup>  
 Pallet dim. (LxWxH): 120 x 80 x 14.4  
 Bruto height: 224.4 cm  
 Bruto pallet volume: 2.154 m<sup>3</sup>  
 Pallet: 84 boxes

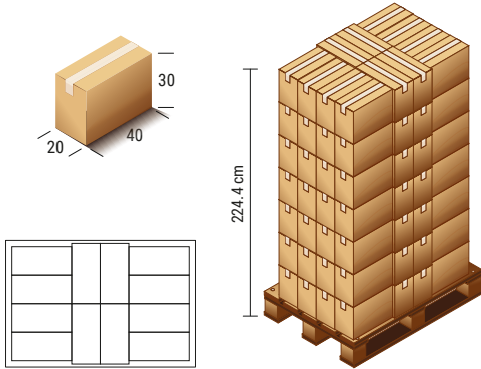

**BOX P2**

Box dim. (LxWxH): 40 x 40 x 30 cm  
 Box volume: 0.048 m<sup>3</sup>  
 Pallet dim. (LxWxH): 120 x 80 x 14.4  
 Bruto height: 224.4 cm  
 Bruto pallet volume: 2.154 m<sup>3</sup>  
 Pallet: 42 boxes

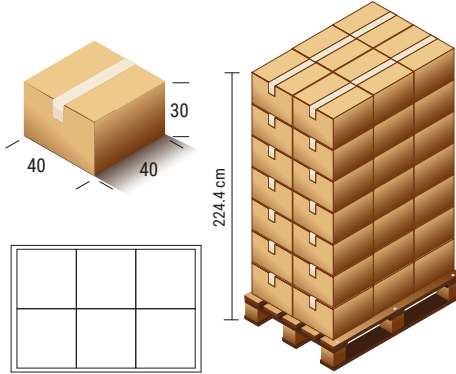

**BOX P3**

Box dim. (LxWxH): 60 x 40 x 30 cm  
 Box volume: 0.072 m<sup>3</sup>  
 Pallet dim. (LxWxH): 120x80x14.4  
 Bruto height: 224.4 cm  
 Bruto pallet volume: 2.154 m<sup>3</sup>  
 Pallet: 28 boxes

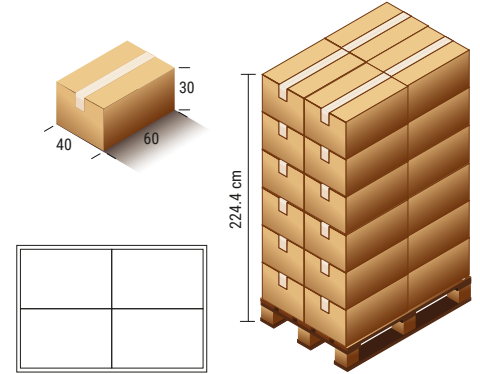

**BOX P4**

Box dim. (LxWxH): 60 x 40 x 45 cm  
 Box volume: 0.108 m<sup>3</sup>  
 Pallet dim. (LxWxH): 120 x 80 x 14.4  
 Bruto height: 194.4 cm  
 Bruto pallet volume: 1.728 m<sup>3</sup>  
 Pallet: 16 boxes

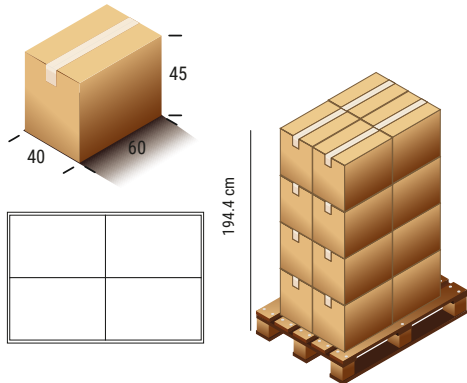

**BOX P5**

Box dim. (LxWxH): 60 x 41 x 41 cm  
 Box volume: 0.101 m<sup>3</sup>  
 Pallet dim. (LxWxH): 120 x 80 x 14.4  
 Bruto height: 219.4 cm  
 Bruto pallet volume: 2.112 m<sup>3</sup>  
 Pallet: 20 boxes

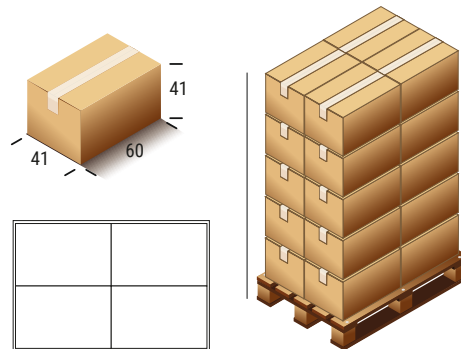

**BOX P6**

Box dim. (LxWxH): 60 x 46 x 64 cm  
 Box volume: 0.177 m<sup>3</sup>  
 Pallet dim. (LxWxH): 120 x 80 x 14.4  
 Bruto height: 206.4 cm  
 Bruto pallet volume: 1.987 m<sup>3</sup>  
 Pallet: 12 boxes

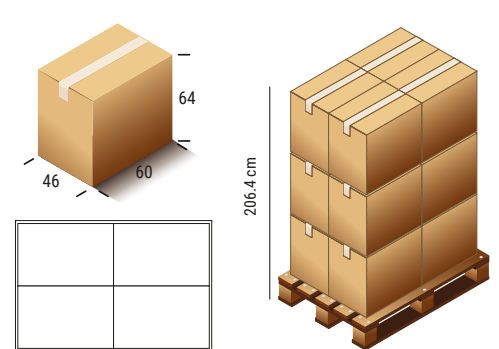

**RASTER**

**GRASS SAVER**

Dim. (LxWxH): 48 x 48 x 4.8 cm  
 1 piece: 0.2304 m<sup>2</sup> ; 0.011 m<sup>3</sup>  
 Pallet dim. (LxWxH): 150 x 100 x 14.4 cm  
 Bruto height: 240 cm  
 Bruto pallet volume: 3.675 m<sup>3</sup>  
 282 Pcs/pallet - 22 Pallet/Truck

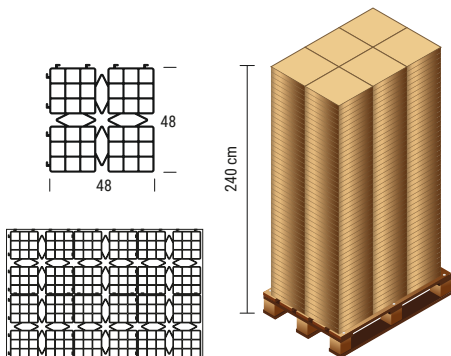

**POLITAPE / POLIFLAT**

1000 m

Reel dim. (LxWxH): 37x25.5 cm  
 1 piece: 0.027 m<sup>3</sup>  
 Pallet dim. (LxWxH): 136 x 125 x 14.4 cm  
 Bruto height: 114.4 cm  
 Bruto pallet volume: 1.945 m<sup>3</sup>  
 48 Reel/pallet - 40 Pallet/Truck

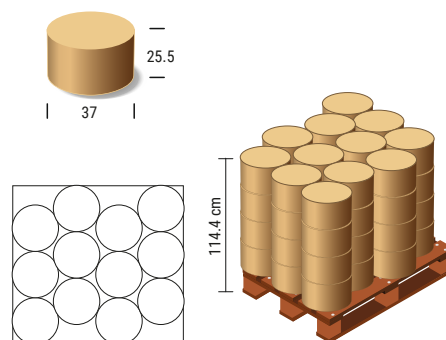

**POLITAPE / POLIFLAT**

6 mil - 3000 m  
 8 mil - 2500 m  
 10 mil - 2000 m  
 12 mil - 1500 m

Reel dim. (LxWxH): 55x25.5 cm  
 1 piece: 0.061 m<sup>3</sup>  
 Pallet dim. (LxWxH): 120x110x14.4 cm  
 Bruto height: 244 cm  
 Bruto pallet volume: 3.221 m<sup>3</sup>  
 36 Reel/pallet - 22 Pallet/Truck

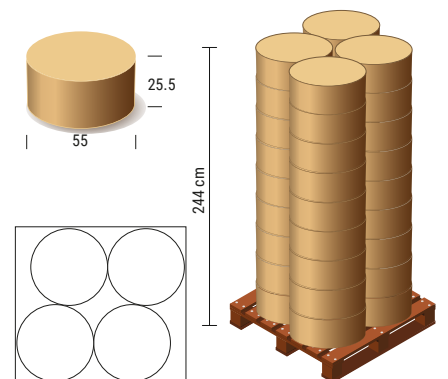

**PoliTape 50m**

Reel dim. (Ø/H): 12.5 x 29 cm  
 Reel volume: 0.030 m<sup>3</sup>  
 Pallet dim. (LxWxH): 120 x 80 x 14.4  
 Bruto height: 217.4 cm 217.4 cm  
 Bruto pallet volume: 3.953 m<sup>3</sup>  
 420 Reels/Pallet - 33 Pallet/Truck

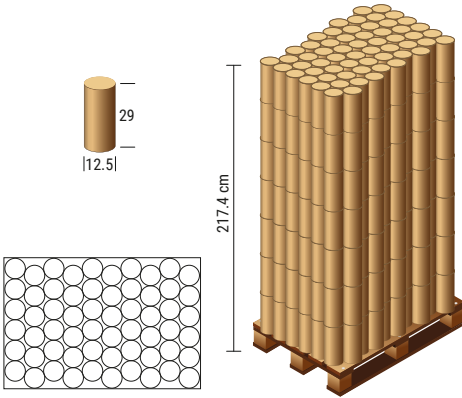

**PoliTape**

Reel dim. (Ø/H): 16 x 29 cm  
 Reel volume: 0.006 m<sup>3</sup>  
 Pallet dim. (LxWxH): 120 x 80 x 14.4  
 Bruto height: 217.4 cm  
 Bruto pallet volume: 2.087 m<sup>3</sup>  
 280 Reels/Pallet - 33 Pallet/Truck

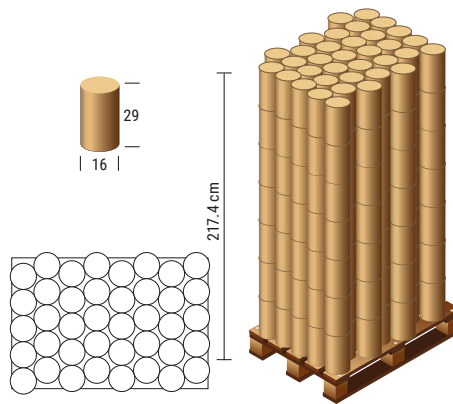

**PoliTape 500 m**

Reel dim. (Ø/H): 22 x 29 cm  
 Reel volume: 0.011 m<sup>3</sup>  
 Pallet dim. (LxWxH): 120 x 80 x 14.4  
 Bruto height: 188.4 cm  
 Bruto pallet volume: 1.809 m<sup>3</sup>  
 90 Reels/Pallet - 33 Pallet/Truck

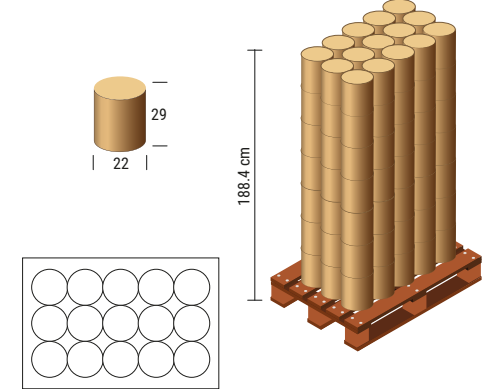

**Flex pipe d16 - 30m**

Reel dim. (Ø/H): 52 x 10 cm  
 Reel volume: 0.021 m<sup>3</sup>  
 Pallet dim. (LxWxH): 100 x 100 x 14.4  
 Bruto height: 234.4 cm  
 Bruto pallet volume: 2.344 m<sup>3</sup>  
 85 Coils/Pallet - 26 Pallet/Truck

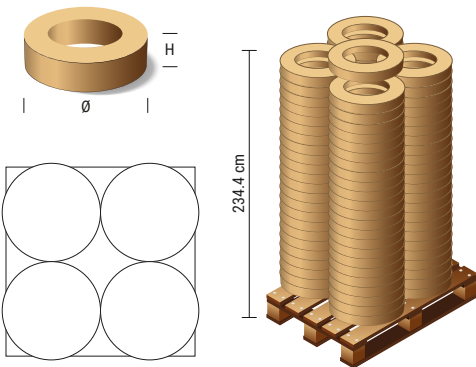

**PoliDrip d16 - 25m**

Reel dim. (Ø/H): 48 x 8.8 cm  
 Reel volume: 0.025 m<sup>3</sup>  
 Pallet dim. (LxWxH): 130 x 110 x 14.5  
 Bruto height: 130 cm  
 Bruto pallet volume: 2.066,35 m<sup>3</sup>  
 65 Coils/Pallet - 44 Pallet/Truck

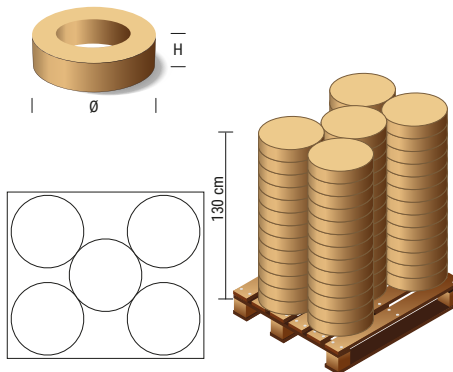

**PoliDrip d16 - 50m**

Reel dim. (Ø/H): 55 x 14.4 cm  
 Reel volume: 0.034 m<sup>3</sup>  
 Pallet dim. (LxWxH): 120 x 120 x 14.5  
 Bruto height: 130 cm  
 Bruto pallet volume: 2.080,8 m<sup>3</sup>  
 32 Coils/Pallet - 44 Pallet/Truck

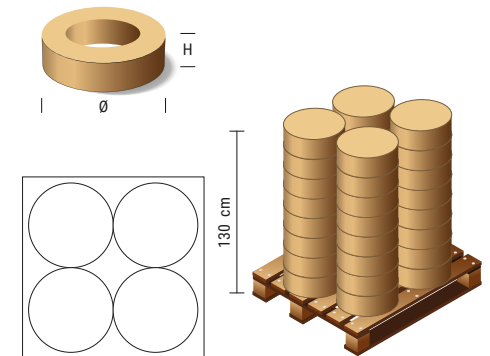

**PoliDrip d16 - 100 m**

Reel dim. (Ø/H): 60 x 18 cm  
 Reel volume: 0.051 m<sup>3</sup>  
 Pallet dim. (LxWxH): 120 x 120 x 14.4  
 Bruto height: 130 cm  
 Bruto pallet volume: 2.080,8 m<sup>3</sup>  
 24 Coils/Pallet - 44 Pallet/Truck

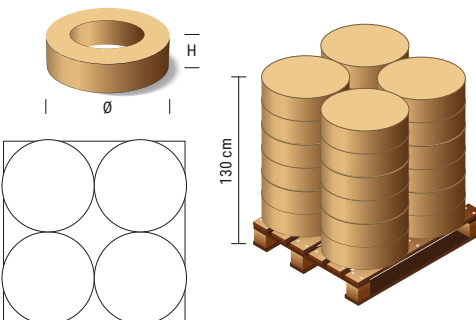

**PoliDrip d16 - 300 m**

Reel dim. (Ø/H): 74 x 29.5 cm  
 Reel volume: 0.127 m<sup>3</sup>

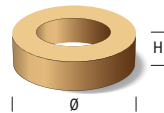

**PoliDrip d20 - 100 m**

Coil dim. (Ø/H): 82 x 15 cm  
 Coil volume: 0.079 m<sup>3</sup>

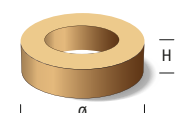

**PoliDrip d20 - 300 m**

Coil dim. (Ø/H): 99 x 30 cm  
 Coil volume: 0.231 m<sup>3</sup>

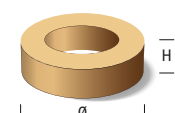

The general terms of sale hereby stated apply to all orders received by the Seller after the issue of this pricelist and will be considered as accepted in full upon placement of order by the CUSTOMER.

#### PRICES

- Prices are Ex-Works (INCOTERMS: EXW) and include standard packing costs.
- Special packing if requested upon placement of order and accepted by the Seller will be charged extra.
- Prices are subject to variation without any prior notice.
- Minimum order value is 500 EUR in case of export. Any order placed under given value 15 EUR management fee is charged.
- Our sales prices fixed in EUR, but if the CUSTOMER requests HUF price can be used based on daily exchange rate of Hungarian National Bank published on the date when invoice created.

#### PRODUCT ORDERS

- Orders must be placed electronically or in writing according to codes and descriptions as per pricelist.
- Quantities must be adjusted to standard packing.
- Orders can be dispatched in successive stages.
- The CUSTOMER does not have the right to cancel entirely or partially the order.

#### PRODUCT MODIFICATION

The Seller reserves the right to make alterations that are considered necessary for the best operation of products as referred to in a pricelist without adversely affecting the use and initial function. This does not constitute reason for the CUSTOMER to withdraw orders or to claim compensations or reimbursements of any kind.

#### DELIVERY OF PRODUCTS

- Products are sold Ex-Works (INCOTERMS: EXW).
- If means of transport are not clearly indicated by the CUSTOMER, delivery will be carried out in cost-saving way and according to the best knowledge, as much as possible.
- Products are transported at the CUSTOMER own risk BECAUSE the products are sold EXW.
- Insurance is provided only if requested and is charged to the CUSTOMER.
- The Seller does not have any responsibility for damages incurred during transport.
- The CUSTOMER is obligated to inform immediately the freight company upon receipt of products for shortages or damages of the goods and to state if such has occurred on the bill of delivery.
- The Seller reserves the right to suspend the delivery of products if at any time receives information that the CUSTOMER is in a financial position that would create any doubt as to his solvency or the CUSTOMER has delayed payments from previous supply of products. The CUSTOMER informed in writing about any suspend the Seller make in case of delivery.

#### GUARANTEE

- Warranty is limited to repair and/or replacement of our products whose failure is due to material or manufacturing defects attributable to Poliext. Warranty is limited to the repair or replacement of defective products with the complete exclusion of any other responsibility, particularly with the exclusion of any compensation or acknowledgement of the damage caused by the use of our products.
- The warranty does not cover the following defects:
  - If the consumer does not comply with the rules on use, transport, storage, installation and operation.
  - The presence of traces of exposure to substances aggressive to the materials of the product.
  - The presence of damage caused by fire, natural disaster, force majeure.
  - Damage caused by incorrect actions of the consumer.
- The Seller, who undertakes the warranty in order to fulfill the contract, or have legal duty to provide warranty, is obligated to take responsibility for incorrect fulfillment, during the warranty period, based on the warranty statement or the terms of law. The Seller is exempt from warranty, if proved that the cause of fault aroused after fulfillment.
- The warranty claim can be validated during warranty period. In case if the Seller does not fulfill the warranty obligation – on time - despite the CUSTOMER notice, the Warranty Claim can be endorsed in the court of law for 3 months passed the warranty period. The omission of the warranty term results forfeitures of its right.
- In case of incorrect fulfillment based on the edict of 151/2003. (IX.22.) for each durable consumer goods, the Seller is obligated to warranty, if the CUSTOMER is qualified as consumer according to Civil Code. The obligated warranty valid for the goods listed in the attachment of the above-mentioned edict.

• Based on the edict 151/2003. (IX.22.) about the detailed norms of contracts between the consumer / CUSTOMER and Companies, the warranty period is divided according to the value:

- o If the selling price is between 10.000 HUF and 100.000 HUF, warranty period is 1 year.
- o If the selling price is between 100.000 HUF and 250.000 HUF, warranty period is 2 years.
- o If the selling price is above 250.000 HUF, warranty period is 3 years.

• The rules of edict 151/2003. (IX.22.) should be used for contracts between the consumer/ CUSTOMER and the Seller.

- For the goods turned over by us, we undertake 1 year warranty based on Hungarian law, except all the Pedrollo pumps, which warranty is indicated by the producer.
- The warranty lost its validity in case if the CUSTOMER did not use the product as intended.

#### CLAIMS

- The CUSTOMER must check the received goods. If the claim is not justified, the costs of diagnostics and examination of the product are paid by the CUSTOMER.
- All claims must be submitted electronically or in writing within 7 days from receipt of products or defects discovered.
- No claim will be accepted for goods which have not been paid.

#### RETURNED PRODUCTS

- Claims for return of merchandise should be made within 7 days from delivery date.
- No returns will be accepted without any prior notice electronically or in writing, and above all firstly approved by the Seller.
- Returned merchandise should be perfectly packed and freight prepared.
- Returns of special orders with special characteristics are not accepted.
- Credit notes issued shall be deducted from following invoices.

#### OWNERSHIP

Delivered products remain the Seller's property until they are fully paid.

#### PAYMENTS

- In no case as well as for no reason, the CUSTOMER cannot postpone payment beyond the agreed terms of payment according to the relevant issued invoices.
- In case of delayed payment, the legal current interest rate will be charged as defined in Civil Code.

#### COMPETENT COURT













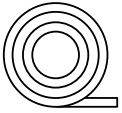





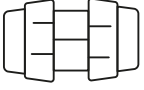

- The Seller/ service body intend to settle disputes by peaceful negotiation procedure based on signed contract. If the Seller/ service body and the CUSTOMER failed to negotiate peacefully, and still have legal disputes or to any future disputes arising out of a particular legal relationship - based on transaction value - Kecskeméti District Court will have jurisdiction of the district court for any disputes and Kecskeméti Court of Justice exclusive jurisdiction of the general court for all disputes.
- The jurisdiction stipulated by the parties does not affect the right of the CUSTOMER who are consumers according to the Civil Code, in case of claims arising out of a contractual relationship with the Seller/service body, the CUSTOMER/ consumer has the right to settle disputes to competent court of the CUSTOMER'S residence or commorancy.
- In case of any issue arise regarding text of General Terms of Sale because of the understanding of Hungarian and English version, always Hungarian version is the standard to be used.
- Legal relationship is according to Hungarian Law.

#### VALIDITY AND ACCEPTANCE

- These conditions are to be considered valid and applicable and accepted by the CUSTOMER.
- This pricelist is subject to change without prior notice and fully replaces all previous versions.

*The dimensions shown in the catalogue may change without notice as a result of technical updating. We do not take responsibility for any omissions that might occur as a result of typing or printing errors.*

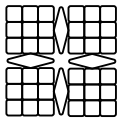
# Certificates

 <p><b>Quality Management</b></p>				
 <p><b>PE100 Pipes</b></p>	<div style="display: flex; justify-content: space-around; align-items: flex-start;"> <div style="text-align: center;">  <p><b>DVGW</b> GERMANY</p> </div> <div style="text-align: center;">  <p><b>UBA</b> GERMANY</p> </div> <div style="text-align: center;">  <p><b>ÖNORM</b> AUSTRIA</p> </div> <div style="text-align: center;">  <p><b>OIB</b> AUSTRIA</p> </div> </div> <div style="text-align: center; margin-top: 20px;">  <p><b>ÉMI</b> HUNGARY</p> </div>			
 <p><b>PP Compression Fittings PN16</b></p>	<div style="display: flex; justify-content: space-around; align-items: flex-start;"> <div style="text-align: center;">  <p><b>DVGW</b> GERMANY</p> </div> <div style="text-align: center;">  <p><b>UBA</b> GERMANY</p> </div> <div style="text-align: center;">  <p><b>ÖNORM</b> AUSTRIA</p> </div> <div style="text-align: center;">  <p><b>OIB</b> AUSTRIA</p> </div> </div> <div style="display: flex; justify-content: space-around; align-items: flex-start; margin-top: 20px;"> <div style="text-align: center;">  <p><b>KIWA</b> HOLLAND</p> </div> <div style="text-align: center;">  <p><b>ÉMI</b> HUNGARY</p> </div> <div style="text-align: center;">  <p><b>ACS</b> FRANCE</p> </div> <div style="text-align: center;">  <p><b>ITC</b> CZECH REPUBLIC</p> </div> </div> <div style="text-align: center; margin-top: 20px;">  <p><b>IzOK MP</b> SERBIA</p> </div>			
 <p><b>Grass Saver Raster</b></p>	<div style="display: flex; justify-content: space-around; align-items: flex-start;"> <div style="text-align: center;">  <p><b>ÉMI</b> HUNGARY</p> </div> <div style="text-align: center;">  <p><b>BECETEL®</b> BELGIUM</p> </div> </div>			



Kecskemét is situated near the middle of highway M5, which connects the Hungary's Nord and South.

The shortest way to reach Matko is following Exit 91 to KecskemétDél (Kecskemét-South). Afterward the subway No. 54 should be chosen by turning left to Soltvadkert. Then a white POLIEXT sign must be noticed on the right side of the road. At this point, you have to leave road 54 by turning left. You should drive straight till the POLIEXT Company's facility is seen on the left side. Following our map, from Exit 91 to Poliext Company, you have to drive 5,5 km.

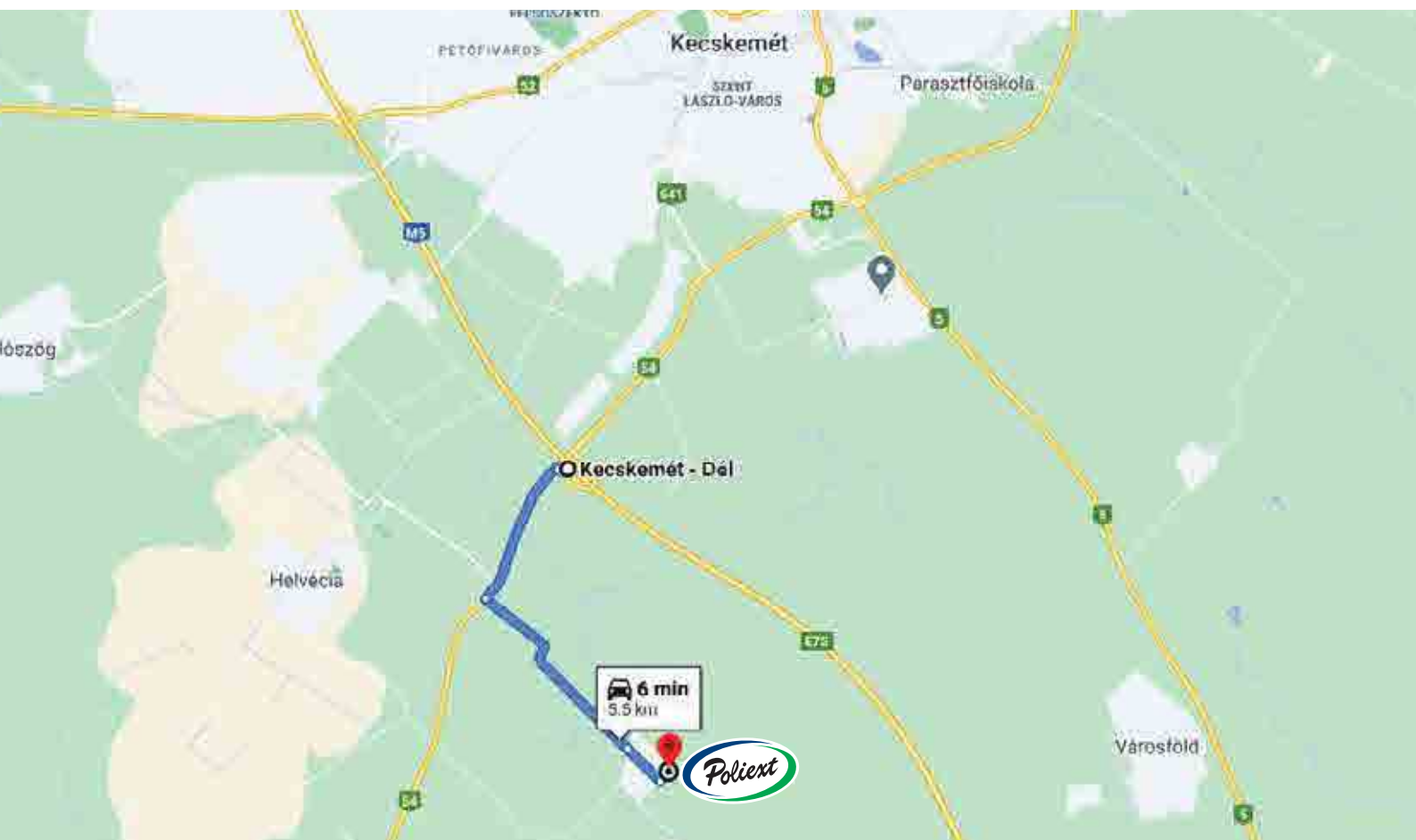

Scan and follow exact location to our company

GPS: N46,81467 – E19,68021

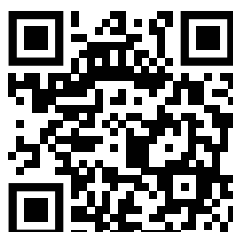

*Have a nice trip and welcome to our company!*





Poliext Kft.  
6000 Kecskemét, Matkó tanya 232. - Hungary  
Tel: +36 76 415 770 / Fax: +36 76 502 709  
Email: [export@poliext.hu](mailto:export@poliext.hu)

[www.poliext.com](http://www.poliext.com)

