

Webb **ewo**

X-SERIES

WEV20X2ABBARE & WEV20X2ABB4X 40V CORDLESS AXIAL BLOWER

Product Number: 1938381001

en - ORIGINAL INSTRUCTIONS

ASSEMBLY REQUIRED
MINIMUM TWO PERSONS

Service & Support: 01793 333212

Before use please read & understand this manual; paying particular attention to the safety instructions before use. Incorrect use of the product could put the operator or machine in danger.

Whilst every effort has been made to ensure the accuracy of information contained in this manual, our policy of continuous improvement determines the right to make modifications without prior warning. Images are used for illustration purposes only.

ADVANCED 40V BATTERY TECHNOLOGY

The logo for Webb eco, featuring the word "Webb" in white and "eco" in green, both enclosed in a white rounded rectangle.

X-SERIES

INSTRUCTION MANUAL

Copyright Notice

Copyright © Handy Distribution

Permission is granted to reproduce this publication for personal & educational use only.

Commercial copying, redistribution, hiring or lending is prohibited.

No part of this publication may be stored in a retrieval system or transmitted in any other form or means without written permission from Handy Distribution.

In all cases this copyright notice must remain intact.



CONTENTS

SPECIFICATION

IMPORTANT INFORMATION

SAFETY SYMBOLS & INSTRUCTIONS

KNOW YOUR MACHINE

SET UP & PREPARATION FOR OPERATION

ASSEMBLY

OPERATION

MAINTENANCE, CLEANING & STORAGE

TROUBLE SHOOTING

PARTS DIAGRAM & LIST

DECLARATION OF CONFORMITY

WARRANTY

ASSEMBLY IS REQUIRED

- This product requires assembly before use.
- See “Assembly” section for instructions.
- Inspect all components closely upon receipt to make sure no items are missing or damaged.



WARNING

Read this instruction manual carefully before operating this machine. Make sure that you are familiar with the controls and properly operate the machine. Following these instructions can reduce the risk of personal injury.



SPECIFICATION

The manufacturer reserves the right to change the product specification and livery according to continued product improvements.

TOOL	
Model No.	WEV20X2ABB4X - WEV20X2ABBARE
Product No.	1938381001
Rated Voltage	36VDC – Max: 40VDC
Rotation Speed	9000-23000 min ⁻¹
Protection	IPX0
Max. Airflow	13.8 m ³ /min
Max. Air Speed	124 mph – 200 km/h
Run Time	up to 80 min – speed dependent
Protection	Class III
Guaranteed Sound Power Level	102 dB(A)
Vibration ahV	2.90 m/s ² – K= 1.5 m/s ²
CHARGER	
Model No.	WEV20X265WCHARGER
Product No.	1938389001
Rating	input: 240V 50/60Hz Type C1 output: 20V – 3.25A Type C1+Type C2 output: 20V 2.3+1A
Protection	IPX0
Charging Time	1x20v 4Ah Battery = 80 min 2x20v 4Ah Battery = 160 min
BATTERY	
Model No.	WEV20B4XSERIES
Product No.	1938390001
Technical data	20V 4Ah 80Wh

Recommended Operating Temp	0-40°C
Recommended Storage Temp	0-40°C
Recommended Charging Temp	Charge as instructed in the manual



WARNING

Only use authorised batteries and chargers.
Use of other branded batteries and chargers may cause injury and/or fire.

NOTE: WEV20X2ABB4X includes the charger and batteries. WEV20X2ABBARE does not include the charger and batteries.

The manufacturer reserves the right to change the product specification and livery according to continued product improvements.

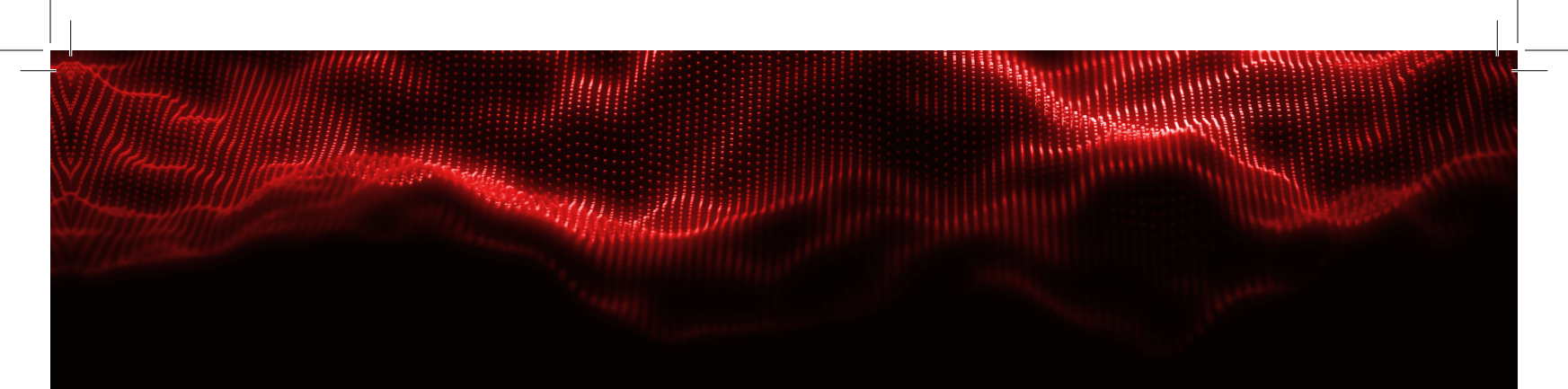

Consistent with our policy of continuous improvement, The Handy reserves the right to change the design and configuration of any of its products without notice or obligation. Therefore, please treat the text and images in this manual for illustrative purposes only. They may in no case serve as a basis for any legal claim.

If you require any assistance with regards to the contents or operation of your machine, please contact us: Tel: 01793 333212 - Email: cs@webbgardenpower.co.uk

Monday to Friday: 8:00am - 5:00pm

(CLOSED WEEKENDS - BANK HOLIDAYS – BUSINESS CLOSURES)

IMPORTANT INFORMATION



WARNING

Read this instruction manual carefully before operating this machine. Make sure that you are familiar with the controls and properly operate the machine. Following these instructions can reduce the risk of fire, electric shock and personal injury.

INTENDED USAGE

The basic version of the equipment is a cordless blower intended for private use, i.e., for use in home and domestic gardening environments. It is designed for clearing leaves, grass cuttings and other small debris in small to medium sized gardens. Any use not expressly permitted in this manual may damage the blower and pose a serious danger to the user.

USE CORRECTLY.

The blower is for private use only, whose annual operating time generally does not exceed 50 hours. Public facilities, sporting facilities and agricultural / forestry applications are excluded. Please read this entire manual prior to operating the equipment. It instructs you how to safely and easily set up, operate and maintain your machine. Please be sure that you and any other persons who will operate the machine, always carefully follow the recommended safety practices. Failure to do so could result in personal injury or property damage.

IF NOT USED PROPERLY THIS MACHINE CAN BE DANGEROUS!

This machine can cause serious injury to the operator and others; the warning and safety instructions must be followed to ensure reasonable safety and efficiency in using this product. The operator is responsible for following the warning and safety instructions in this manual and on the machine. Never use the product unless the components are correctly positioned and operational.

TRAINING

Read the instructions carefully: Be familiar with the controls and the proper use of the equipment. Never allow children or people unfamiliar with these instructions to use the product. Local regulations can restrict the age of the operator. Keep in mind that the operator or user is responsible for accidents or hazards involving the machine that occur to other people or their property.

TO THE OWNER

All information in this manual is relative to the most recent product information available at the time of printing. Review this manual frequently to familiarise yourself with the machine, its features and operation. Please be aware that this Instruction Manual may cover a range of product specifications for various models. Characteristics and features discussed and/or illustrated in this manual may not be applicable or exact to all models.

We reserve the right to change product specifications, design, and equipment without notice and without incurring obligation. If you have any problems or questions concerning the machine, phone your local authorised Webb service dealer or ourselves. Throughout this manual, all references to *right* and *left* side of the machine are observed from the operating position.

Webb **eco**

X-SERIES

INSTRUCTION MANUAL

























WARNING

The operator or user is responsible for accidents and injury or damage to third parties. The equipment is allowed to be used only for its prescribed purpose. Any other use is deemed to be a case of misuse. The user/operator and not the manufacturer will be liable for any damage or injuries of any kind resulting from such misuse. Please note that our equipment has not been designed for use in commercial, hire, trade, or industrial applications. Our warranty will be 90 days from the original date of sale for commercial, hire, trade, or industrial businesses or for equivalent purposes.









SAFETY SYMBOLS & INSTRUCTIONS

Read and understand the owner's manual and labels affixed to the machine. Learn its application and limitations as well as the specific potential hazards. Retain these instructions for future reference. The operator is responsible for following the warnings & instructions in this manual and on the product.

	<p>Read & understand operator's manual before using the machine. Failure to follow instructions could result in death or serious injury.</p>		<p>Check your machine before turning it on. Keep guards in place & in working order. Frequently check to see that foreign objects are removed from the working area before turning it on. Replace damaged, missing or failed parts before using it.</p>
	<p>Keep all bystanders & animals at least 15 metres away from the machine during operation. Thrown objects can ricochet and result in personal injury or property damage. If approached, stop the machine immediately.</p>		<p>When working with the tool:</p> <ul style="list-style-type: none"> • Wear eye protection. • Wear ear protection. • Wear protective gloves. • Wear respiratory protection. • Wear sturdy shoes.
	<p>Moving Parts - Risk of Injury Rotating parts can contact or entangle hands, feet, hair, clothing or accessories. Traumatic amputation or severe laceration can result.</p>		<p>Risk of injury caused by rotating machine parts</p>
	<p>For the charger: Remove plug from the mains immediately if the cable is damaged or cut. Only re-charge the battery pack indoors</p>		<p>Do not expose the tool, battery or charger to rain or damp conditions. Failure to use it in dry conditions and to observe safe practices can result in electric shock.</p>
	<p>Do not disassemble, crush, heat above 212°F(100°C); Never expose the battery to microwaves or high pressures.</p>		<p>Warning; Disconnect battery before maintenance</p>
	<p>Do not dispose of battery packs in rivers or immerse in water.</p>		<p>Do not dispose of battery packs in fire. They will explode and cause injury.</p>
	<p>Do not dispose of a battery pack with the household waste!</p>		<p>Use and store the battery within a temperature below 122°F(50°C).</p>

	Safety alert symbol. Used to alert you to potential personal injury hazards. Obey all safety messages that follow this symbol to avoid possible injury.	 DANGER	Indicates an imminently hazardous situation which, if not avoided, will result in serious injury.
 WARNING	Indicates a potentially hazardous situation which, if not avoided, could result in serious injury.	 CAUTION	Indicates a potentially hazardous situation which, if not avoided, may result in minor or moderate injury.
CAUTION	Used without the safety alert symbol indicates a potentially hazardous situation which, if not avoided, may result in property damage.	 	Waste electrical products must not be disposed of with household waste. Please recycle where facilities exist. Check with your local authorities or retailer for recycling advice.
	Sound Power Level (Image used for illustration purposes only, check machine and Declaration of Conformity for actual reading)	 Li-ion	Battery Li-ion: Recyclable

BATTERY & CHARGER

	Read & understand operator's manual before using the machine. Failure to follow instructions could result in death or serious injury. Please keep in a safe place for future reference.	 WARNING	Indicates a potentially hazardous situation which, if not avoided, could result in serious injury.
	For indoor use only.		Double Insulation
 MAX. 40°C	Ambient temperature 40°C max. (only for battery)	 	Waste electrical products MUST NOT be disposed of with household waste. Please recycle where facilities exist. Check with your local authority or retailer for recycling advice.
	Do not incinerate battery pack or charger.		

NOISE

Tested to fulfill all relevant provisions of Noise Emission Directive 2000/14/EC amended by 2005/88/EC: Guaranteed Sound Power Level (L_{WA}): **102 dB(A)**

NOTE: The declared noise emission value(s) has been measured in accordance with a standard test method and may be used for comparing one tool with another.

NOTE: The declared noise emission value(s) may also be used in a preliminary assessment of exposure.



WARNING

Wear ear protection.

The noise emission during actual use of the power tool can differ from the declared value(s) depending on the ways in which the tool is used especially what kind of workpiece is processed.

Be sure to identify safety measures to protect the operators that are based on an estimation of exposure in the actual conditions of use (taking account of all parts of the operating cycle such as the times when the tool is switched off and when it is running idle in addition to the trigger time).

VIBRATION

The vibration total value (tri-axial vector sum) determined according to EN 62841-1, EN 50636-2-100 Annex BB. Vibration emission (a_h): **2.90 m/s² - uncertainty (K): 1.5 m/s²**.

NOTE: The declared vibration total value(s) has been measured in accordance with a standard test method and may be used for comparing one tool with another.

NOTE: The declared vibration total value(s) may also be used in a preliminary assessment of exposure.



WARNING

The vibration emission during actual use of the power tool can differ from the declared value(s) depending on the ways in which the tool is used especially what kind of workpiece is processed.

Be sure to identify safety measures to protect the operators that are based on an estimation of exposure in the actual conditions of use (taking account of all parts of the operating cycle such as the times when the tool is switched off and when it is running idle in addition to the trigger time).

GENERAL SAFETY RULES



WARNING

Before you put the machine into operation, you must read this instruction manual.

When using this machine, observe the following safety instructions to remove the risk of personal injury or material damage. Please also observe the special safety instructions in the respective chapters. Where applicable, follow the legal directives or regulations for the prevention of accidents in relation to the use of this machine.

When using electric/battery tools, basic safety precautions, including the following, should always be followed to reduce the risk of serious personal injury and/or damage to the unit.

Read all safety warnings and all instructions. Failure to follow the warnings and instructions may result in electric shock, fire and/or serious injury.

Save all warnings and instructions for future reference. The term "power tool" in the warnings refers to your mains-operated (corded) power tool or battery-operated (cordless) power tool.

SAVE ALL WARNINGS AND INSTRUCTIONS FOR FUTURE REFERENCE.

The term "power tool" in the warnings refers to your mains operated (corded) power tool or battery operated (cordless) power tool.

X-SERIES

INSTRUCTION MANUAL

WORK AREA SAFETY

1. Keep work area clean and well lit. Cluttered or dark areas invite accidents.
2. Do not operate power tools in explosive atmospheres, such as in the presence of flammable liquids, gases or dust. Power tools create sparks which may ignite the dust or fumes.
3. Keep children & bystanders away when operating a tool. Distractions can cause a loss of control.

ELECTRICAL SAFETY

1. Charger plugs must match the outlet. Never modify the plug in any way. Unmodified plugs and matching outlets will reduce risk of electric shock.
2. Avoid body contact with earthed or grounded surfaces, such as pipes, radiators, ranges and refrigerators. There is an increased risk of electric shock if your body is earthed or grounded.
3. Do not operate in rain or wet conditions. This may increase the risk of electric shock.
4. Do not abuse the cord. Never use the cord for carrying, pulling or unplugging the power tool. Keep cord away from heat, oil, sharp edges or moving parts. Damaged or entangled cords increase the risk of electric shock.

PERSONAL SAFETY

1. Stay alert, watch what you are doing and use common sense when operating a power tool. Do not use a power tool while you are tired or under the influence of drugs, alcohol or medication. A moment of inattention while operating power tools may result in serious personal injury.
2. Use personal protective equipment. Always wear eye protection. Protective equipment such as a dust mask, non-skid safety shoes, hard hat or hearing protection used for appropriate conditions will reduce personal injuries.
3. Prevent unintentional starting. Ensure the switch is in the off position before connecting to power source and/or battery, picking up or carrying the tool. Carrying power tools with your finger on the switch or energising power tools that have the switch on invites accidents.
4. Remove any adjusting key or spanner before turning the power tool on. A spanner or a key left attached to a rotating part of the power tool may result in personal injury.
5. Do not overreach. Always keep proper footing and balance. This enables better control of the power tool in unexpected situations.
6. Dress properly. Do not wear loose clothing or jewellery. Keep your hair and clothing away from moving parts. Loose clothes, jewellery or long hair can be caught in moving parts.
7. Do not let familiarity gained from frequent use allow you to become complacent and ignore tool safety principles. A careless action can cause severe injury within a fraction of a second.
8. Always wear protective goggles to protect your eyes from injury when using power tools. The goggles must comply with EN 166 in UK & Europe.

POWER TOOL USE AND CARE

1. Do not force the power tool. Use the correct power tool for your application. The correct power tool will do the job better and safer at the rate for which it was designed.
2. Do not use the power tool if the on/off switch does not turn it on and off. Any power tool that cannot be controlled with the on/off switch is dangerous and must be repaired.
3. Disconnect the plug from the power source and/or remove the battery, if detachable, from the power tool before making any adjustments, changing accessories, or storing. Such preventive safety measures reduce the risk of starting the power tool accidentally.
4. Store idle power tools out of the reach of children. Do not allow persons unfamiliar with the power tool/instructions to operate. Power tools are dangerous in the hands of untrained users.
5. Maintain power tools and accessories. Check for misalignment or binding of moving parts, breakages and any other conditions that may affect the power tool's operation. If damaged, have the power tool repaired before use. Many accidents are caused by poor maintenance.
6. Use the power tool, accessories and tool bits etc. in accordance with these instructions, consider the working conditions and the work to be performed. Use of the power tool for operations different from its tested operation could result in a hazardous situation.
7. Keep handles and grasping surfaces dry, clean and free from oil and grease. Slippery handles and grasping surfaces do not allow for safe handling and control of the tool in unexpected situations.
8. When using the tool, do not wear cloth work gloves which may be entangled. The entanglement of cloth work gloves in the moving parts may result in personal injury.

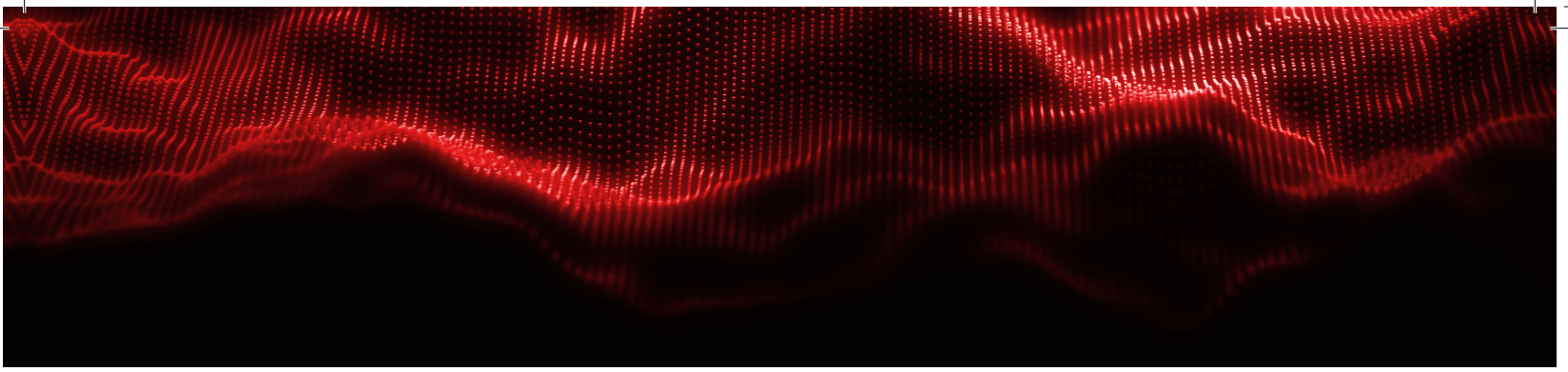

BATTERY TOOL USE AND CARE

1. Recharge only with the charger specified by the manufacturer. A charger that is suitable for one type of battery may create a risk of fire when used with another battery.
2. Use power tools only with specifically designated battery. Use of any other battery may create a risk of injury and fire.
3. When a battery is not in use, keep it away from other metal objects, like paper clips, coins, keys, nails, screws or other small metal objects, that can make a connection from one terminal to another. Shorting the battery terminals together may cause burns or a fire.
4. Under abusive conditions, liquid may be ejected from the battery; avoid contact. If contact accidentally occurs, flush with water. If liquid contacts eyes, additionally seek medical help. Liquid ejected from the battery may cause irritation or burns.
5. Do not use a battery or tool that is damaged or modified. Damaged or modified batteries may exhibit unpredictable behaviour resulting in fire, explosion, or risk of injury.
6. Do not expose a battery or tool to fire or excessive temperature. Exposure to fire or temperature above 130°C may cause explosion.
7. Follow all charging instructions and do not charge the battery or tool outside the temperature range specified in the instructions. Charging improperly or at temperatures outside the specified range may damage the battery and increase the risk of fire.

SERVICE

1. Have your power tool serviced by a qualified repair person using only identical replacement parts. This will ensure that the safety of the power tool is maintained.
2. Never service damaged batteries. Batteries are unserviceable.
3. Follow instruction for lubricating and changing accessories.

CORDLESS BLOWER SAFETY WARNINGS

1. Do not use the power tool in bad weather conditions, especially when there is a risk of lightning. This decreases the risk of being struck by lightning.
2. Thoroughly inspect the area for wildlife where the power tool is to be used. Wildlife may be injured by the power tool during operation.
3. Thoroughly inspect the area where the power tool is to be used and remove all stones, sticks, wires, bones, and other foreign objects. Thrown objects can cause personal injury.
4. Before using the power tool, always visually inspect to see that the power tool assembly is not worn or damaged. Worn or damaged parts increase the risk of injury.
5. Keep guards in place. Guards must be in working order and be properly mounted. A guard that is loose, damaged, or is not functioning correctly may result in personal injury.
6. Keep all cooling air inlets clear of debris. Blocked air inlets may result in overheating or risk of fire.
7. While operating the power tool, always wear non-slip and protective footwear. Do not operate the power tool when barefoot or wearing open sandals. This reduces the chance of injury to the feet from contact with the moving debris.
8. While operating the power tool, always wear long trousers. Exposed skin increases the likelihood of injury from thrown objects.
9. Do not operate the power tool in wet grass. Walk, never run. This reduces the risk of slipping and falling which may result in personal injury.
10. Do not operate the power tool on excessively steep slopes. This reduces the risk of loss of control, slipping and falling which may result in personal injury.
11. When working on slopes, always be sure of your footing, always work across the face of slopes, never up or down and exercise extreme caution when changing direction. This reduces the risk of loss of control, slipping and falling which may result in personal injury.
12. Use extreme caution when reversing or pulling the power tool towards you. Always be aware of your surroundings. This reduces the risk of tripping during operation.
13. Do not touch internal fan blades and other hazardous moving parts while they are still in motion. This reduces the risk of injury from moving parts.
14. When clearing jammed material or cleaning the power tool, make sure all power switches are off and the battery is disconnected. Unexpected operation of the power tool may result in serious personal injury.
15. Do not place the power tool down on gravel while it is switched on.

IMPORTANT SAFETY INSTRUCTIONS**WARNING**

DO NOT let comfort or familiarity with product (gained from repeated use) replace strict adherence to safety rules for the subject product.

MISUSE or failure to follow the safety rules stated in this instruction manual may cause serious personal injury.

TRAINING

1. Read the instructions carefully. Be familiar with the controls and the proper use of the power tool.
2. Never allow children or people unfamiliar with these instructions to use the power tool. Local regulations can restrict the age of the operator.
3. Never operate the power tool while people, especially children, or pets are nearby.
4. Keep in mind that the operator or user is responsible for accidents or hazards occurring to other people or their property.
5. Children should be supervised to ensure that they do not play with the power tool.
6. Physical condition - Do not operate the power tool while under the influence of drugs, alcohol, or any medication.

PREPARATION

1. While operating the power tool, always wear substantial footwear and long trousers. Do not operate when barefoot or wearing open sandals. Avoid wearing clothing or jewellery that is loose fitting or that has hanging cords or ties. They can be caught in moving parts.
2. Before use, always visually inspect the power tool for damage, missing or misplaced guards or shields.
3. Be sure the area is clear of other people before operating. Stop the power tool if anyone enters the area.
4. Do not start the power tool until it is ready to be used.
5. Always wear protective goggles to protect your eyes from injury when using power tools. The goggles must comply with EN 166 in UK & Europe.
6. Check the machine carefully for cracks or damage before operation. Replace cracked or damaged components before operating.
7. Remove foreign matters such as rocks, wire, bottles, bones and large sticks from the work area before operating to prevent personal injury or damage to the power tool.
8. The working area should always be carefully examined and cleared of all objects prior to each use.
9. Watch for holes, ruts, bumps, rocks, or other hidden objects. Uneven terrain could cause a slip and fall accident. Tall grass can hide obstacles.
10. Use personal protective equipment. Always wear eye protection. Protective equipment such as a dust mask, non-skid safety shoes, hard hat or hearing protection used for appropriate conditions will reduce personal injuries.

OPERATION

1. Do not overreach. Always keep your balance. Walk, never run.
2. Always be sure of your footing on slopes. Operate across the face of slopes, never up and down. Exercise extreme caution when changing direction on slopes. Do not operate on excessively steep slopes over 15° degrees gradient.
3. Stop the power tool and remove the battery, and make sure that all moving parts have come to a complete stop:
 - whenever you leave the power tool,
 - before checking, cleaning or working on the power tool,
 - after striking a foreign object. Inspect the power tool for damage and make repairs before restarting and operating the power tool,
 - whenever the power tool starts vibrating abnormally.
4. Never operate the power tool with defective guards or shields, or without safety devices, for example deflectors and/or grass basket, in place.

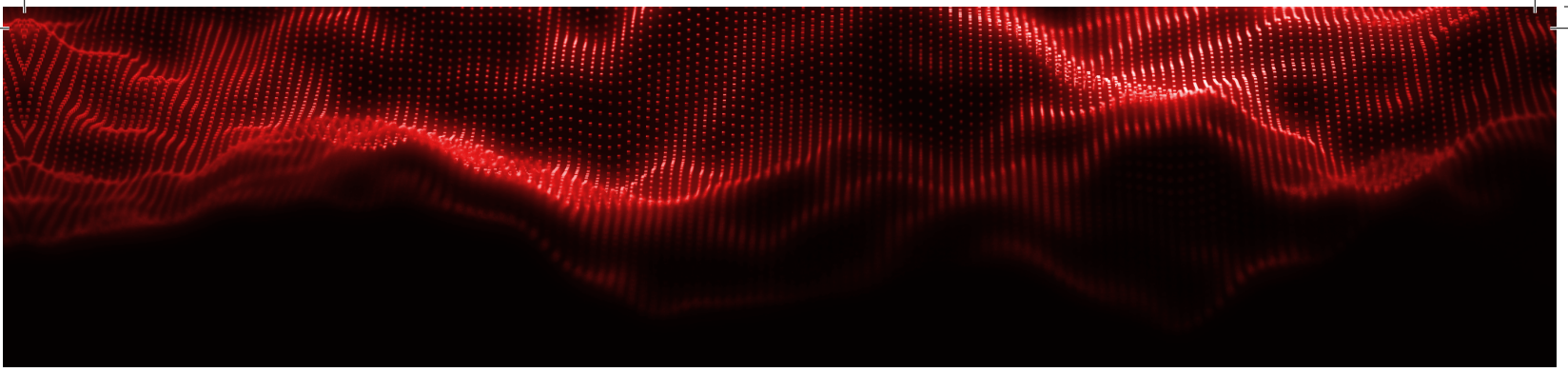

5. Avoid using the power tool in bad weather conditions, especially when there is a risk of lightning.
6. Always wear eye protection and sturdy shoes while operating the power tool.
7. Operate the power tool only in daylight or in good artificial light.
8. Start the power tool carefully according to the instructions.
9. Always ensure that the air vent openings are kept clear of debris.
10. Use extreme caution when moving backwards.
11. Stop the power tool and remove the battery for transportation, crossing surfaces other than grass, and when transporting the power tool to and from the area to be used.
12. Do not put hands or feet near or under rotating parts. Keep clear of the air discharge opening at all times.
13. Do not transport the power tool while it is turned on.
14. Always keep a firm hold on the handle.
15. Keep hands and feet away from rotating fans. **Caution** – Fans can coast after the power tool is switched off.
16. Stop operation immediately if you notice anything unusual. Switch off the power tool and remove the battery. Then inspect the machine.
17. Remove the battery if you leave the power tool, reach to pick up or remove something out of your way, or for any other reason that may distract you from what you are doing.
18. If the power tool strikes a foreign object, follow these steps:
 - Stop the power tool, release the trigger and wait until the motor and fan comes to a complete stop.
 - Remove the battery.
 - Thoroughly inspect the power tool for any damage.
 - Replace the fan if it is damaged in any way. A damaged fan will cause excessive vibrations through the power tool handle. Repair any damage before restarting and continuing to operate the power tool.
19. Do not start the power tool when standing in front of any bystander, child or animal.
20. If the power tool starts to vibrate abnormally (check immediately)
 - inspect for damage,
 - replace or repair any damaged parts,
 - check for and tighten any loose parts.
21. Never directly blow material towards anyone. Avoid discharging material against a wall or obstruction. Material may ricochet back toward the operator. Stop the power tool when crossing gravel surfaces.
22. When you are compelled to move backwards from a fence or other similar obstruction, look down and behind before and while moving backwards.
23. When used on muddy ground, wet slope, or slippery place, pay attention to your footing.
24. Do not submerge the machine into a puddle.

MAINTENANCE & STORAGE

1. Replace worn or damaged parts for safety. Use only genuine replacement parts and accessories.
2. Inspect and maintain the power tool regularly.
3. When not in use, store the power tool out of the reach of children.
4. Keep all nuts, bolts, and screws tight to be sure the equipment is in safe working condition.
5. Use only the manufacturer genuine replacement parts specified in this manual.
6. Always allow the power tool to cool down before storing.
7. When undertaking cleaning, maintenance or storage of the power tool, remove the battery.
8. Never remove or tamper with safety devices. Check their proper operation regularly. Never do anything to interfere with the intended function of a safety device or to reduce the protection provided by a safety device.
9. Do not leave the machine unattended outdoors in the rain.
10. When storing the machine, avoid direct sunlight and rain, and store it in a place where it does not get hot or humid. Recommended storage temperature 0-40°C (32-104°F).

BATTERY TOOL AND CARE

1. Recharge only with the charger specified by Webb. A charger that is suitable for one type of battery may create a risk of fire when used with another battery.
2. Use power tools only with specifically designated battery. Use of any other battery may create a risk of injury and fire.
3. When battery is not in use, keep it away from other metal objects, like paper clips, coins, keys, nails, screws or other small metal objects, that can make a connection from one terminal to another. Shorting the battery terminals together may cause burns or a fire.
4. Under abusive conditions, liquid may be ejected from the battery; avoid contact. If contact accidentally occurs, flush with water. If liquid contacts eyes, additionally seek medical help. Liquid ejected from the battery may cause irritation or burns.
5. Do not use a battery, charger or tool that is damaged or modified. Damaged or modified batteries may exhibit unpredictable behaviour resulting in fire, explosion or risk of injury.
6. Do not expose a battery, charger or tool to fire or excessive temperature. Exposure to fire or temperature above 130°C may cause explosion.
7. Follow all charging, operation and storage instructions. Do not charge the battery outside the temperature range specified in the instructions. Charging improperly or at temperatures outside the specified range may damage the battery and increase the risk of fire. Recommended charging temperature 5-35°C (41-95°F).

ELECTRICAL & BATTERY SAFETY

1. Do not dispose of the battery(ies) in a fire. The cell may explode. Check with your local authority for possible special disposal instructions.
2. Do not open or mutilate the battery(ies). Released electrolyte is corrosive and may cause damage to the eyes or skin. It may be toxic if swallowed.
3. Do not charge the battery in rain, or in wet locations.
4. Do not charge the battery outdoors.
5. Do not handle the charger, including charger plug, and charger terminals with wet hands.
6. Do not replace the battery in the rain.
7. Do not wet the terminal of the battery with liquid such as water or submerge the battery. Do not leave the battery in the rain, or charge, use, or store the battery in a damp or wet place. If the terminal gets wet or liquid enters inside of battery, the battery may be short circuited and there is a risk of overheating, fire, or explosion.
8. After removing the battery from the machine or charger, be sure to attach the battery cover to the battery and store it in a dry place.
9. Do not replace the battery with wet hands.
10. Avoid dangerous environments. Do not use the machine in damp or wet locations or expose it to rain. Water entering the machine will increase the risk of electric shock.

SERVICE

1. Have your power tool serviced by a Webb Service Dealer or a qualified repair person using only identical replacement parts. This will ensure that the safety of the power tool is maintained.
2. Never service damaged batteries.



WARNING

DO NOT let comfort or familiarity with product (gained from repeated use) replace strict adherence to safety rules for the subject product.

MISUSE or failure to follow the safety rules stated in this instruction manual may cause serious personal injury.



IMPORTANT SAFETY INSTRUCTIONS FOR BATTERIES

1. Before using a battery, read all instructions and cautionary markings on (1) battery charger, (2) battery, and (3) product using battery.
2. Do not disassemble or tamper with the battery. It may result in a fire, excessive heat, or explosion.
3. If operating time has become excessively shorter, stop operating immediately. It may result in a risk of overheating, possible burns and even an explosion.
4. If electrolyte gets into your eyes, rinse them out with clear water and seek medical attention right away. It may result in loss of your eyesight.
5. Do not short the battery:
 - Do not touch the terminals with any conductive material.
 - Avoid storing battery in a container with other metal objects such as nails, coins, etc.
 - Do not expose battery to water or rain.

A battery short can cause a large current flow, overheating, possible burns and even a breakdown.

6. Do not store or use the tool & battery where the temperature may reach or exceed 50°C (122°F).
7. Do not incinerate the battery cartridge even if it is severely damaged or is completely worn out. The battery cartridge can explode in a fire.
8. Do not nail, cut, crush, throw, drop the battery cartridge, or hit against a hard object to the battery cartridge. Such conduct may result in a fire, excessive heat, or explosion.
9. Do not use a damaged battery.
10. The contained lithium-ion batteries are subject to the Dangerous Goods Legislation requirements. For commercial transports e.g. by third parties, forwarding agents, special requirement on packaging and labeling must be observed. For preparation of the item being shipped, consulting an expert for hazardous material is required. Please also observe possibly more detailed national regulations. Tape or mask off open contacts and pack up the battery in such a manner that it cannot move around in the packaging.
11. When disposing of the battery, remove it from the tool and dispose of it in a safe place. Follow your local regulations relating to disposal of lithium-ion batteries.
12. Use the batteries only with the products specified by Webb. Installing the batteries to non-compliant products may result in a fire, excessive heat, explosion, or leak of electrolyte.
13. If the tool is not used for a long period of time, the battery must be removed from the tool.
14. During and after use, the battery may take on heat which can cause burns or low temperature burns. Pay attention to the handling of hot batteries.
15. Do not touch the terminal of the tool immediately after use. It may get hot and cause burns.
16. Do not allow clippings, dust, or soil to stick into the terminals, holes & grooves of the battery. It may cause heat, catch fire, burst & malfunction of the tool or battery, resulting in burns or personal injury.
17. Do not use the battery near high-voltage electrical power lines. It may result in a malfunction or breakdown of the tool or battery.
18. Keep the battery away from children.



CAUTION

ONLY USE GENUINE WEBB BATTERIES

Use of non-genuine Webb batteries, or batteries that have been altered, may result in the battery bursting causing fires, personal injury and damage. It will also void the warranty for the tool and charger.

TIPS FOR MAINTAINING MAXIMUM BATTERY LIFE

1. Charge the battery before completely discharged. Always stop tool operation and charge the battery when you notice less tool power.
2. Never recharge a fully charged battery. Overcharging shortens the battery service life.
3. Charge the battery with room temperature at 10°C-40°C (50°F-104°F). Let a hot battery cool down before charging it.
4. When not using the battery, remove it from the tool or the charger.
5. Charge the battery if you do not use it for a long period (more than three months).

Webb **elo**

X-SERIES

INSTRUCTION MANUAL

KNOW YOUR MACHINE –WEV20X2ABB4X - WEV20X2ABBARE

NOTE: WEV20X2ABB4X includes the charger and batteries. WEV20X2ABBARE does not include the charger and batteries.

1. Blower Body	2. Blow Tube
3. Tube Release Button	4. Handle
5. Control Panel	6. Shoulder Strap Hook
7. Air Speed Indicator	8. Battery Life Indicator
9. Reduce Speed Button	10. Increase Speed Button
11. Turbo Speed Button	12. ON/OFF Button
13. Shoulder Strap	14. Battery Port
15. 2x 20v 4Ah Battery	16. Fast Charger



SET UP & PREPARATION FOR OPERATION

This product must be assembled correctly before use. Carefully remove the product and any accessories from the carton. Inspect the product carefully to make sure there are no breakages or missing items during shipping. Do not discard the packing material and carton until you have carefully inspected and satisfactorily operated the product.



WARNING

If any parts are damaged or missing, do not operate this product until the parts are replaced. Failure to heed this warning could result in serious personal injury.

Do not attempt to modify this product or create accessories not recommended for use with this product. Any such alteration or modification is misuse and could result in a hazardous condition leading to possible serious personal injury.

Read and follow all instructions for assembly and operation. Failure to properly assemble this equipment could result in serious injury to the user or bystanders, or cause equipment damage.



WARNING

The device and packaging materials are not toys!

Children must not be allowed to play with plastic bags, film, sharp objects, and small parts!

There is a risk of cuts, swallowing and suffocation!

Always be sure that the battery is removed before carrying out any work on the power tool. Failure to remove the battery may result in serious personal injury from accidental start-up.

Never start the power tool unless it is completely assembled. Operation of the machine in a partially assembled state may result in serious personal injury from accidental start-up.

ASSEMBLY



WARNING

In the unlikely event your machine is damaged prior to assembly or operation, do not attempt to operate the machine. Contact your retailer for assistance.

ASSEMBLY/PRE-OPERATION

This manual gives instructions on the correct assembly and safe use of your machine. It is important that you read these instructions carefully. If necessary, obtain assistance to remove from packaging, and assemble.

REMOVE CONTENTS FROM CARTON

Lift the power tool out of the carton and check thoroughly for additional loose parts/accessories. Please ensure that you have all the necessary parts/accessories, before commencing with the assembly. In the unlikely event that you are missing a component, please do contact us for assistance.

If you require any assistance with regards to the contents or operation of your machine, please contact us: Tel: 01793 333212 - Email: cs@webbgardenpower.co.uk

Monday to Friday: 8:00am - 5:00pm

(CLOSED WEEKENDS - BANK HOLIDAYS – BUSINESS CLOSURES)



WARNING

Always be sure that the battery is removed before carrying out any work on the power tool. Failure to remove the battery may result in serious personal injury from accidental start-up.

Never start the power tool unless it is completely assembled. Operation of the machine in a partially assembled state may result in serious personal injury from accidental start-up.

Webb **eco**

X-SERIES

INSTRUCTION MANUAL

ASSEMBLING TUBES

1. Align the notches on the power tool with the notches on the tube, slide together until they click into place.
2. To remove the blower tube, push the release buttons (3) and pull the tube away from the body.

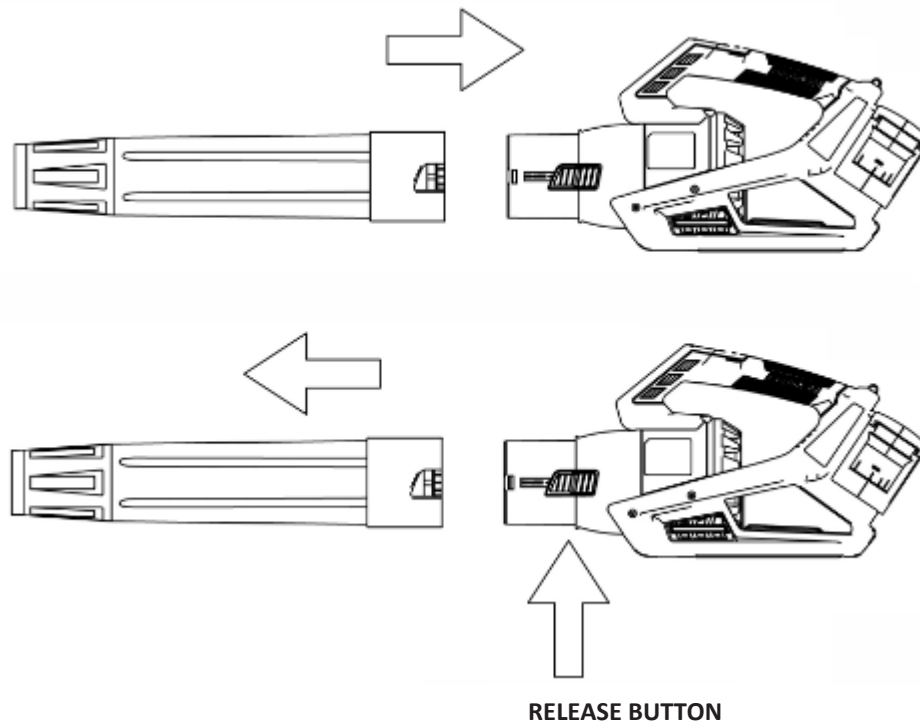

ATTACHING SHOULDER STRAP

For extra support when you use the Power tool, a shoulder strap is included. Attach the strap to the product before operation.

1. Snap the clasp of the shoulder strap (13), onto the hook (6) located on the body of the machine.

OPERATION

CHARGING BATTERY



CAUTION

Use only authorised Webb 20v Lithium-ion batteries.

Batteries are shipped in a low charge condition to prevent possible problems. Therefore, you should charge them prior to use.

NOTE: Batteries will not reach full charge the first time they are charged. Allow several cycles (operating tool followed by recharging batteries) for them to fully charge.

TO CHARGE

1. Use this charger only with Authorised Webb 20v Lithium-ion batteries.
2. Never attempt to charge non-rechargeable batteries.
3. Make sure the power supply is normal UK home voltage, 230 volts, 50 Hz, AC only.
4. Connect the charger to the power supply. The charger light will illuminate **GREEN** indicating power is on.
5. Slide the battery onto charger.
6. Press down on battery to be sure contacts on the battery engage correctly with the charger contacts.
7. When the battery and charger are connected correctly, the charger light will be a flickering **RED** to indicate the battery is charging.
8. A constant **GREEN** light indicates the battery is fully charged.
9. A minimum charge time of 80 minutes (1x 4Ah battery) or 160 minutes (2x 4Ah battery) is required to recharge a completely discharged battery.
10. The battery will become slightly warm to the touch while charging. This is normal and does not indicate a problem.
11. **DO NOT** place a charger in an area of extreme heat or cold. It will work best if stored and operated in normal room temperature.
12. Frequently monitor the charger and battery while connected.
13. When the battery is fully charged, unplug your charger from power supply and remove the battery from the charger.
14. Allow the battery to cool completely before attempting to use it.

NOTE: If the battery does not fit properly, disconnect it and confirm that the battery is the correct model for the charger supplied. Do not charge any other battery or any battery that does not securely fit the charger.



CAUTION

**When in continuous operation in a tool, the battery will become hot!
Allow the battery to cool down to room temperature for approximately 30 minutes, before attempting to recharge. This will extend the life of your batteries.**

X-SERIES

INSTRUCTION MANUAL

INSTALLING OR REMOVING BATTERIES



CAUTION

Always switch off the machine before installing or removing batteries.

Hold the machine and the battery firmly when installing or removing batteries. Failure to hold the machine and battery firmly may cause them to slip out of the machine or your hands and result in damage to the machine and batteries and a personal injury.

Always install the batteries fully until an audible click is heard. If not, they may accidentally fall out of the machine, causing injury to you or someone around you.

Do not install the batteries with excessive force. If the battery does not slide in easily, it is not being inserted correctly or it is the incorrect battery.

Hold the battery cover firmly when installing or removing the battery.

INSTALLING BATTERIES

1. To install the battery, ensure the battery release button of the battery is at the top and the base of the battery is facing the front of the machine.
2. Align the battery with the groove in the battery housing and slide it into place. Insert it all the way until it locks in place with an audible click.

REMOVING BATTERIES

To remove the batteries from the power tool.

1. Press the battery release button and remove each battery individually. Do not attempt to remove both batteries at the same time.
2. Slide out the battery from the power tool. Repeat for the second battery.



MACHINE & BATTERY PROTECTION

The power tool is equipped with a machine or battery protection system. The system can automatically cut off the power supply to the motor to extend the lifespan of the machine and battery. If the machine or battery is in one of the following conditions, the machine will automatically stop during operation.

OVERLOAD PROTECTION

When a machine or battery operates in a manner that causes it to produce an abnormally high current, the machine automatically shuts down. In this case, shut down the machine and remove the factors that caused the overload. Then turn on the machine to restart.

OVERHEAT PROTECTION

When the machine overheats, it will automatically stop. Let the machine cool down for a minimum period of 15 minutes before attempting to restart. When the battery overheats, the machine automatically stops and restarts after cooling of the battery.

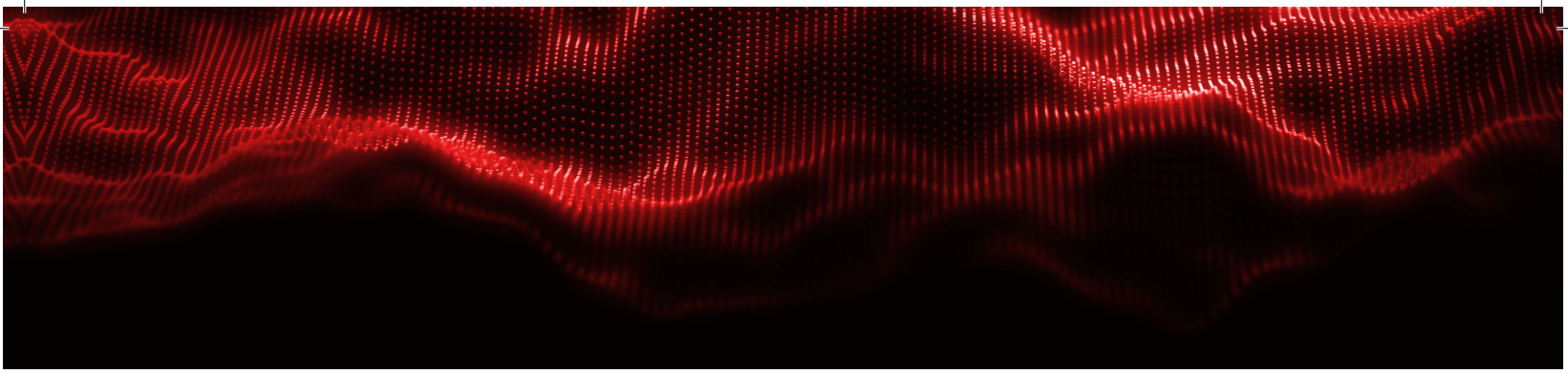

UNDER VOLTAGE PROTECTION

When the battery capacity is low, the machine will automatically stop. If the machine does start, please remove the battery, and then charge the battery to its full capacity.

PROTECTION AGAINST OTHER CAUSES

Protection system is also designed for other causes that could damage the machine and allows the machine to stop automatically. Take all the following steps to clear the causes when the machine has been brought to a temporary halt or stop in operation.

- Turn the machine off, then turn it on again to restart.
- Charge the battery(ies) or replace it/them with recharged battery(ies).
- Let the machine and battery(ies) cool down.

If no improvement can be found by restoring the protection system, then contact Webb Garden Power.

BATTERY INDICATOR

Press the Red check release button on the battery to indicate the remaining battery capacity. The LED indicator lights will illuminate for a few seconds.



LED LIGHTS	BATTERY CAPACITY
LED 1,2 & 3 on	Full charged (66-100%)
LED 1 & 2 on	Battery is 33%-66% charged
LED 1 on	Battery is depleted (0%-33%). Charge the battery.

NOTE: Depending on the conditions of use and the ambient temperature, the indication may differ slightly from the actual capacity.

NOTE: The green indicator light will blink when the battery protection system works.

STARTING THE POWER TOOL



WARNING

The power tool requires both batteries to operate.

Use both hands to grip the power tool firmly when switching on & operating.

Do not point the power tool at yourself, bystanders, children or pets.

Before installing the battery, always check to see that the ON/OFF Switch moves freely back and forth.

Operating a machine with a faulty lever can lead to loss of control and serious personal injury.

1. Insert both batteries into the power tool until an audible click is heard as shown below. Make sure the battery is fully seated and fully latched into position.

X-SERIES

INSTRUCTION MANUAL



WARNING

Always wear safety glasses.
Wear a filter face mask if the operation is dusty.
Use of gloves, long trousers and substantial footwear is recommended.
Keep long hair and loose clothing away from openings and moving parts.
THIS POWER TOOL IS FOR DOMESTIC USE ONLY

2. Hold the power tool and press the ON/OFF button (12) on the control panel.



3. Hold the power tool with one hand as shown below and sweep from side to side with the nozzle several inches above the ground.
4. Slowly advance keeping the accumulated pile of debris in front of you.

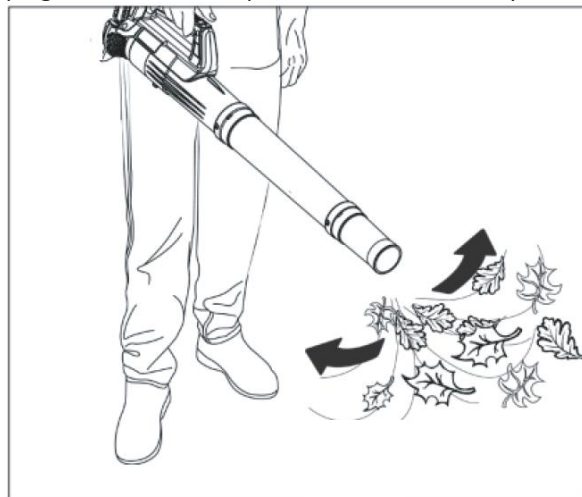

CONTROL PANEL

1. The battery life indicator (8) shows the capacity status of the battery. When it is fully charged, the indicator is green. When the battery is half charged, the colour is yellow. When only 1 LED is lit red, you should charge the battery.
2. The air speed indicator (7) shows the four different air speeds. To lower the speed, press the reduce speed button (9). To up the speed, press the increase speed button (10). The air speed indicator will show which speed you are working in.
3. The turbo button (11) is only used on occasions when leaves and trash are stuck or when the normal airflow is not sufficient. An increase in airflow is used mainly for brief measures. After 15 seconds, the speed will turn back to previous speed automatically. If you need to keep working in turbo speed, you need to press again.

STOPPING THE POWER TOOL

1. Hold the power tool and press the ON/OFF button (12) on the control panel.



CAUTION

Operating on slopes could cause you to lose footing.

Allowing anyone to operate this machine without proper instruction may result in injury.

Wear sturdy, full coverage footwear. Operating this machine with bare feet, or with open toe shoes or sandals increases your risk of injury.

Do not use the machine at night or in poor light.

Be sure to transport the machine from one place to another with the motor off.

To prevent accidents, check the machine for any signs of damage or faults, prior to operating. If the machine is damaged or faulty, do not operate and have inspected by your local Approved Webb Service Dealer.

MAINTENANCE, CLEANING & STORAGE



WARNING

Improper maintenance & storage of the machine may void your warranty. Keep the machine clean for better and safer performance.

Turn off the motor and remove the batteries before performing any maintenance.

Always remove batteries when the power tool is not in use. Store batteries in a safe place out of reach of children.

Wear gloves when performing inspection or maintenance.

NOTE: Never use petrol, benzene, thinner, alcohol or the like on the body and other components. Discoloration, deformation, or cracks may result.

To maintain product SAFETY and RELIABILITY, repairs, any other maintenance, or adjustment should be performed by an approved Webb service dealer or fully trained garden machinery expert, always using original replacement parts.

MAINTENANCE

- Use only Webb recommended parts. Other parts may not perform as well, damage the unit or result in personal injury. The use of non-genuine parts will invalidate the manufacturer's warranty.
- Before each use, check all nuts & bolts to be sure they are sufficiently tightened.
- Our machines have been designed to operate over a long period of time with a minimum of maintenance. Continuous satisfactory operation depends upon proper machine care and regular cleaning.
- To maintain battery capacity, we recommend the battery is completely discharged once month and fully recharged again. Only store with a fully charged battery, top-up the charge from time to time if stored for a long time. Store in a dry and frost-free place, the ambient temperature should not exceed 40°C.

X-SERIES

INSTRUCTION MANUAL

CLEANING



WARNING

Remove the batteries from the power tool before undertaking any cleaning exercise.



CAUTION

Do not use a water hose or pressure washer to clean the machine. Water can damage the motor.

1. Keep your machine clean. Thoroughly clean the machine at the end of each use.
2. Keep the ventilation slots of the machine clean to prevent overheating of the motor.
3. Regularly clean the machine housing with a soft cloth, preferably after each use to remove dust & debris.
4. If the dirt does not come off use a soft cloth moistened with soapy water.
5. Never use solvents such as petrol, alcohol, etc. These solvents may damage the plastic parts.

STORAGE & TRANSPORT

The following steps should be taken to prepare your machine for storage.



CAUTION

The motor/battery must have completely cooled down before storing.

NOTE: When storing any type of power equipment in an unventilated or material storage shed

1. For trouble free service, make sure the machine is clean and dry before storing.
2. Keep the power tool in a dry place out of children's reach. Do not cover the power tool, moisture may develop.
3. Store indoors or in a safe dust free area, locked protected area during severe weather and winter months. If storing for an extended period, inspect, clean and repair the machine if necessary. Please ensure the machine is stored away from direct sunlight.
4. Ensure the machine is stored in a position where any person cannot step on it to attempt to reach items up high, due to risk of movement.

TRANSPORT

- Always remove the batteries from the power tool when transporting.
- Use the original packaging to ship whenever possible.

MAINTENANCE INFORMATION

Please note that the following parts of this product are subject to normal or natural wear and that the following parts are therefore also required for use as consumables with limited or no warranty. Wear & Tear parts*: Carbon brushes, nozzle, tubes (* Not necessarily included in the scope of delivery!)

DISPOSAL

SAFE DISPOSAL OF BATTERIES



Li-ion

Our batteries are designed according to the latest state of technology and optimised for the use in electric tools. Lithium ion cells contain hazardous substances and may therefore not be disposed off with normal household waste. Our batteries are lithium-ion cells and are therefore subject to special disposal regulations. Bring defective batteries to your specialist dealer. Before disposing of the tool, remove the battery. We wish to encourage users to act in an environmentally friendly manner.

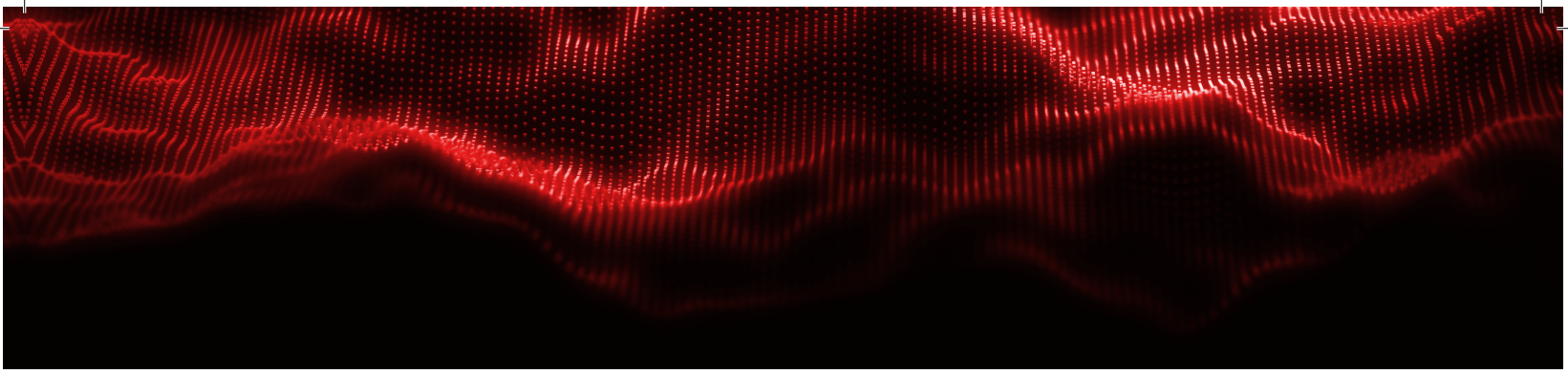

DISPOSAL OF THE TOOL



A crossed-out wheelie bin icon means: Batteries and rechargeable batteries, electrical or electronic devices must not be disposed of with household waste. They may contain substances that are harmful to the environment and human health.

Consumers must dispose of waste electrical devices, spent portable batteries and rechargeable batteries separately from household waste at an official collection point to ensure that these items are processed correctly. The product can be returned free of charge in accordance with the legal requirements, for example through a municipal waste disposal company or a dealer.



Batteries, rechargeable batteries and lamps that are not permanently installed in waste electrical equipment and can be removed in a non-destructive way must be removed and disposed of separately before disposal of the equipment. Lithium batteries and rechargeable battery packs of all systems are only to be handed in to the waste collection points in a discharged state. The batteries must always be protected against short circuits by taping off the poles. All end users are responsible for deleting any personal data stored on waste devices prior to their disposal.

DISPOSAL OF PACKAGING



The packaging consists of cardboard and correspondingly marked plastics that can be recycled.
– Make these materials available for recycling.

TROUBLE SHOOTING

PROBLEM	POSSIBLE CAUSE	SOLUTION
Unit will not start.	<ol style="list-style-type: none"> 1. One or both batteries are depleted. 2. The battery is not attached to the power tool. 3. Battery or power tool circuitry is too hot. 4. The ON/OFF switch is not in the correct position. 	<ol style="list-style-type: none"> 1. Charge the battery. 2. Attach the battery to the power tool correctly. 3. Allow the battery or power tool to cool down. 4. Move the ON/OFF switch to the ON position.
Battery will not charge.	<ol style="list-style-type: none"> 1. Battery not inserted into charger. 2. Charger not plugged in. 3. Surrounding air temperature too hot or too cold. 	<ol style="list-style-type: none"> 1. Insert battery into charger until green LED appears. 2. Plug charger into a working outlet. Refer to "Important Charging Notes" for more details. Check current at receptacle by plugging in a lamp or other appliance. Check to see if receptacle is connected to a light switch which turns power off when you turn out the lights. 3. Move charger and tool to a surrounding air temperature of above 4.5°C or below 40°C.
The air velocity decreases occasionally	<ol style="list-style-type: none"> 1. Excessive wearing of motor fan. 2. Air inlet is blocked by debris 	<ol style="list-style-type: none"> 1. Contact approved Webb service dealer. 2. Remove the battery and clear the debris.

If you cannot fix the fault yourself, contact your local approved Webb service dealer. Please be aware that any improper repairs will also invalidate the warranty and additional costs may be incurred.

PARTS DIAGRAM – WEV20X2ABB4X - WEV20X2ABBARE (1938381001)

NOTE: WEV20X2ABB4X includes the charger and batteries. WEV20X2ABBARE does not include the charger and batteries.

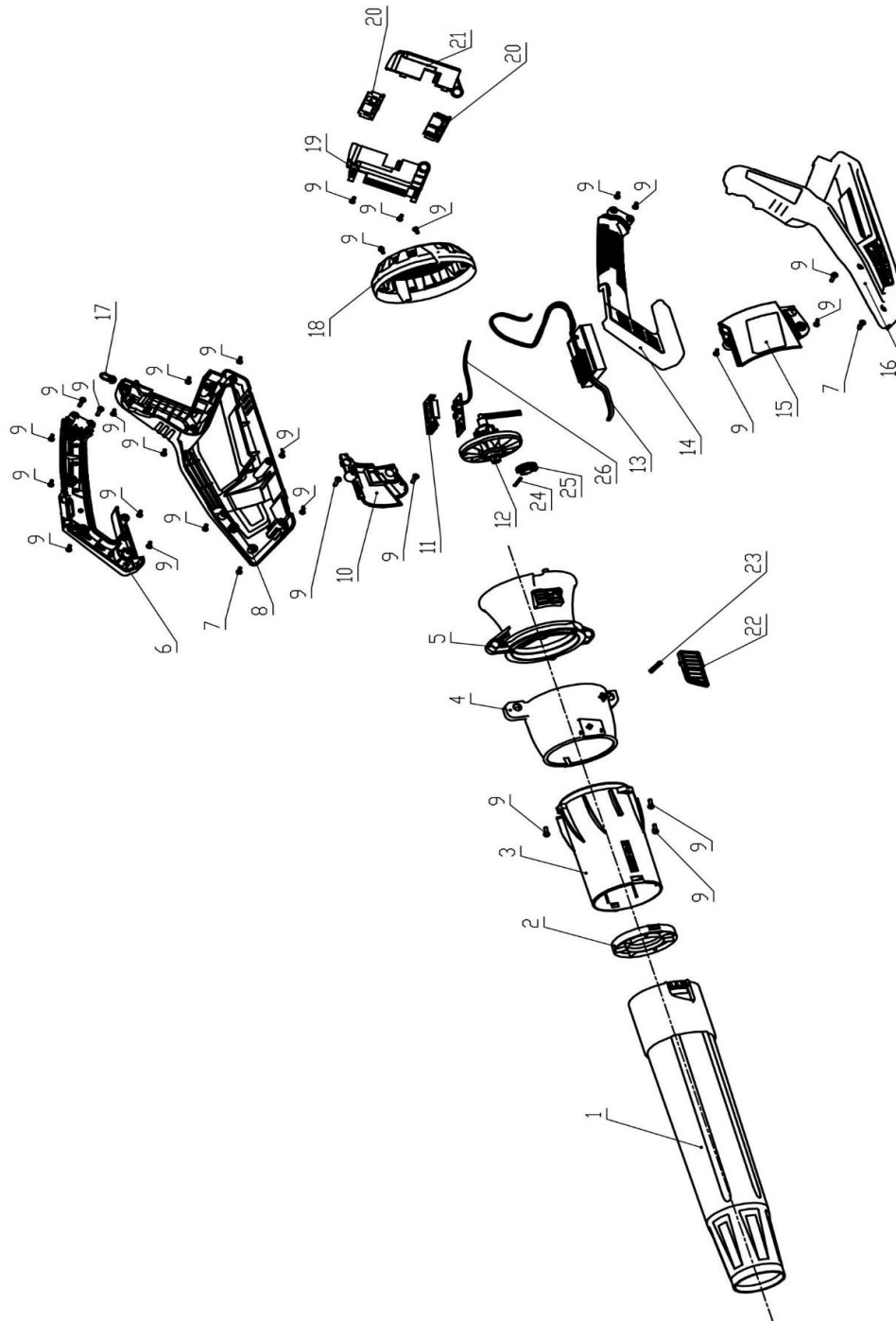

If you wish to purchase Spare Parts, please visit www.webbgardenpower.co.uk and enter your chosen part number in the search bar. If the part is not listed, please contact our Spares Team on **01793 333212 option 2** or email spares@webbgardenpower.co.uk with your requirements, model and part number details (found on the front cover of this instruction manual).

PARTS LIST - WEV20X2ABB4X - WEV20X2ABBARE (1938381001)

NOTE: WEV20X2ABB4X includes the charger and batteries. WEV20X2ABBARE does not include the charger and batteries.

Item No	Webb Part No.	Webb Description	Qty
1	WE267-2548A50901	Tube	1
2	WE267-2498A51103	Safety Baffle	1
3	WE267-2608A51101	Tube Housing	1
4	WE267-4008A51101	Tank	1
5	WE267-3138A51102	Baffle A	1
6	WE267-2978A51102	Right Handle	1
7	WE135-J0010000730R	Screw ST4x8	28
8	WE267-3038A51102	Right Casing	1
9	WE135-J0010001270R	Screw ST4x16	28
10	WE267-2498A51102	Right Connection	1
11	WE267-2168A50803	Display	1
12	WE267-1148A51102	Brushless Motor Assembly	1
13	WE267-3248A51101	Brushless Controller	1
14	WE267-2978A51101	Left Handle	1
15	WE267-2498A51101	Left Connector	1
16	WE267-3038A51101	Left Casing	1
17	WE267-4317A21401	Backstrap Hook	1
18	WE267-3138A51101	Air Intake Cover	1
19	WE267-2468A51103	Upper Battery Base	1
20	WE267-2468J11305	Battery Insert Base Assembly	2
21	WE267-2468A51104	Lower Battery Base	1
22	WE267-2938A50801	Tube Release Button	1
23	WE267-33448A50802	Small Spring	1
24	WE267-3232032501	Pin Shaft ϕ 3x25	1
25	WE267-2868A50702	Rear Motor Bracket	1

If you wish to purchase Spare Parts, please visit www.webbgardenpower.co.uk and enter your chosen part number in the search bar. If the part is not listed, please contact our Spares Team on **01793 333212 option 2** or email spares@webbgardenpower.co.uk with your requirements, model and part number details (found on the front cover of this instruction manual).



DECLARATION OF CONFORMITY

We Handy - SN3 5HY (Importer) declare that the product:

Designation: Lithium Battery Axle Blower
Model(s): WEV20X2ABB4X - WEV20X2ABBARE
Product No.: 1938381001
Type/Serial No. As per rating label on machine
Protection: Class III – IPX0
Rated Voltage: 36V d.c (Max: 40V d.c)
Rotation Speed: 9000-23000 min⁻¹

Complies with the following directives:

Machinery Directive 2006/42/EC

The conformity assessment procedure followed was in accordance with:
EN 60335-1:2012/A15:2021 – EN 50636-2-100:2014 – EN ISO 12100:2010 – EN 62233:2008

Electromagnetic Compatibility Directive 2014/30/EU

The conformity assessment procedure followed was in accordance with:
EN IEC 55014-1:2021 – EN IEC 55014-2:2021

RoHS Directive 2011/65/EU & Amendment 2015/863/EU

The conformity assessment procedure followed was in accordance with EN IEC 63000:2018, IEC62321-XX series (as per latest requirement by some professional EU retailers).

Outdoor Noise Directive 2000/14/EC

The conformity assessment procedure followed was in accordance with EN 50636-2-100
Guaranteed Sound Power Level L_{WA}: 102 dB(A)
Vibration: 2.90 m/s² – uncertainty K=1.5 m/s²

Notified Body:

TÜV SÜD Product Service GmbH

Authorised signatory and technical file holder:

Date: 08/12/2025

Signature:

A handwritten signature in black ink, appearing to read "S Belcher", written over a horizontal line.

Name: Mr Simon Belcher

Position: Chairman

Company: Handy - **Address:** Murdock Rd, Swindon, Wiltshire, SN3 5HY.



X-SERIES

INSTRUCTION MANUAL

This Service Book is provided with your Webb, to help you look after your purchase to our recommendations and enable you to take advantage of the conditional manufacturer domestic warranty*.

Present this service book to your authorised Webb repair dealer, whenever a service or a warranty appraisal is required.

The booklet is applicable to the following products, in the UK only:

- Ride On Lawn Tractors
- Cylinder Lawnmowers
- Petrol Rotary Lawnmowers
- Petrol Hand Held Range

Please register your machine using the following pages or at www.webbgardenpower.co.uk. By registering your machine, you agree to maintain the machine in accordance with the service schedules specified in this manual and services duly recorded. (Not applicable for Webb electric handheld machines). You may be asked to produce this booklet as proof of servicing in the event of a claim. Proof of purchase should also be kept as a reference.

Ensure you have the following information available from your machine product label. The two examples below can be found on your machine:

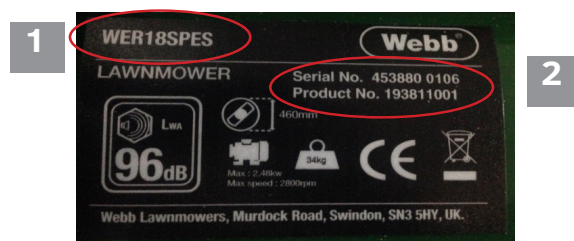

1. Model Number

2. Serial & Product Number

Please complete using BLOCK CAPITALS.
Sections marked* must be completed to validate Warranty.

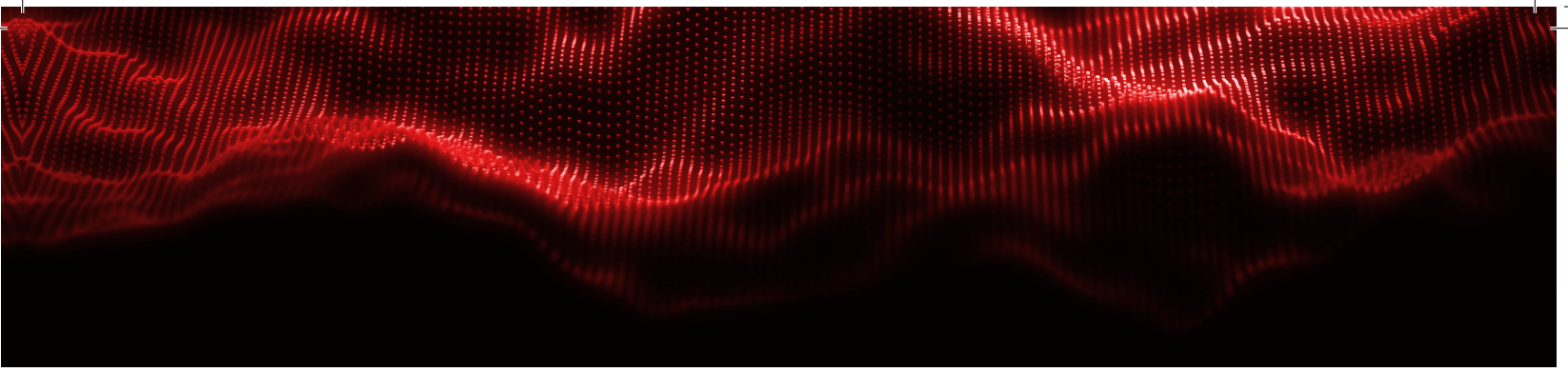

Users Statement of Warranty

Each new machine is warranted against defective material or assembly of material under normal usage. The warranty applies to the original purchaser and covers faulty parts and the labour involved in replacing and repairing those parts, which are of original manufacture.

All claims must be accompanied by evidence of the date of purchase, such as a Sales Receipt showing that the product has been purchased from an approved retailer, it was brand new at time of purchase, which is within the warranty time period.

Period of Warranty

Webb (Green Products)

- a) 3 years from the original date of sale to the first domestic user. (2 years batteries & chargers)
- b) 90 days from the original date of sale to the professional/commercial user.
- c) 90 days from the original date of sale when used for hire.
- d) A reduced warranty period of 90 days applies to those items which are subject to normal wear and tear (e.g. but not limited to wheels, tyres, cutter bars, cylinders, cutting blades, blade boss, belts, cables, nylon line & spool, collection bags, engine spark plugs, electric plug fuses).
- e) Engines are supplied with a separate warranty to the machine. The engine manufacturers warranty statement which will be supplied within the engine instruction manual. All enquiries and warranty repairs should be discussed with the engine manufacturer or approved warranty repair dealer.
- f) 90 days from the original date of purchase for Replacement Spare Parts (unless normal wear & tear component, which are covered for 30 days).
- g) All machines' must be serviced within the first 12 & 24 months from the original date of purchase to comply with the warranty (if applicable), failure to do so will invalidate the 2nd & 3rd years of the warranty.

All warranty repairs must be undertaken by an authorised service dealer. These dealers have been accredited by GJ Handy (Trading) Ltd and agree to only use genuine parts and follow our repair procedures.

Not covered by this warranty

- a) Error in assembly by user in accordance with manufacturers instructions.
- b) Incorrect operation of product in accordance with manufacturers instructions.
- c) The defect is due to accident, misuse, unauthorised modification or inexpert repair.
- d) The warranty policy does not cover any depreciation or damages caused by ordinary wear, rusting or corrosion, lack of correct maintenance or operation, misuse, abuse, lack of transportation or accident.
- e) The warranty policy does not cover any costs necessary for the standard periodic maintenance services instructed by the operator's manual, or service parts replacement which would include oil, filters, tyres, belts, brake linings, fuses, blades, seals and other service parts unless it can be proven that the item has evidence of faulty manufacture.
- f) The warranty policy will not cover failure or damage caused as a result of parts or accessories being modified without the written approval of GJ Handy (Trading) Ltd.
- g) The warranty policy will not cover the unit if non-genuine parts have been fitted and as a result damage has occurred to the unit.

X-SERIES

INSTRUCTION MANUAL

- a) The warranty policy is non-transferable and is only applicable to the original purchaser.

Disclaimer

- a) This warranty is only a remedy for defect of products. GJ Handy (Trading) Ltd will never warranty in terms of the merchantability or the fitness for a particular purpose.
- b) No person is authorised to make any warranties, representations or promises, expressed or implied, on behalf of GJ Handy (Trading) Ltd, or to modify the terms conditions or limitation of this warranty policy in any way.
- c) Neither GJ Handy (Trading) Ltd nor any company affiliated with GJ Handy (Trading) Ltd shall be liable in any event or manner whatsoever for incidental or consequential damages or injuries, including, but not limited to, loss of crops, loss of profit, out of pocket expenses or profits, rental of substitute equipment or other commercial losses.

General

- a) Most warrantable failures show up within the first few weeks of use. These failures are usually straightforward and warranty assessment is relatively easy.
- b) Failures relating to cutter decks and belts need careful investigation, as the cause may not always be straightforward. Look for damage to blades and pulleys especially when the cutter belt or blade boss have snapped or cracked as this could be due to impact damage.
- c) Customers should always refer to the operator/instruction manual when any disputed problem arises, you will find most areas covered within the manual.

Protecting your machine

Maintenance

Regular maintenance of your Webb machine is essential to ensure it operates, safely, efficiently and therefore reducing the environmental impact.

It is the owner's responsibility to ensure that their Webb machine is maintained at specific intervals. Any approved Webb service dealer can undertake a service, which are specialised in our products and will be aware of your particular machine and any technical updates which will save valuable time & money.

If you are using your machine in dry, dusty or high temperatures, you will need to service the machine more regularly.

Fuel (if applicable)

Due to ongoing efforts by fuel companies to reduce emissions, unleaded petrol will oxidize & deteriorate in storage overtime, leaving residue from detergent components.

Fuel deterioration problems may occur when petrol is stored for over 30 days. If you are planning to store fuel for over 30 days, we recommend you add Handy Parts Sure-Start fuel stabilizer to fresh fuel after purchasing. Sure-Start cannot reconstitute stale fuel.

Storage

When storing your machine for an extended period, we do recommend that you follow the instructions of engine instruction manual.

Always store the fuel in a clean, approved and sealed container. If the container is steel, ensure it is not corroded. If the container is not filled to its recommended capacity, air can accelerate fuel deterioration.

Always store fuel away from direct sunlight, in a dark, cool environment.

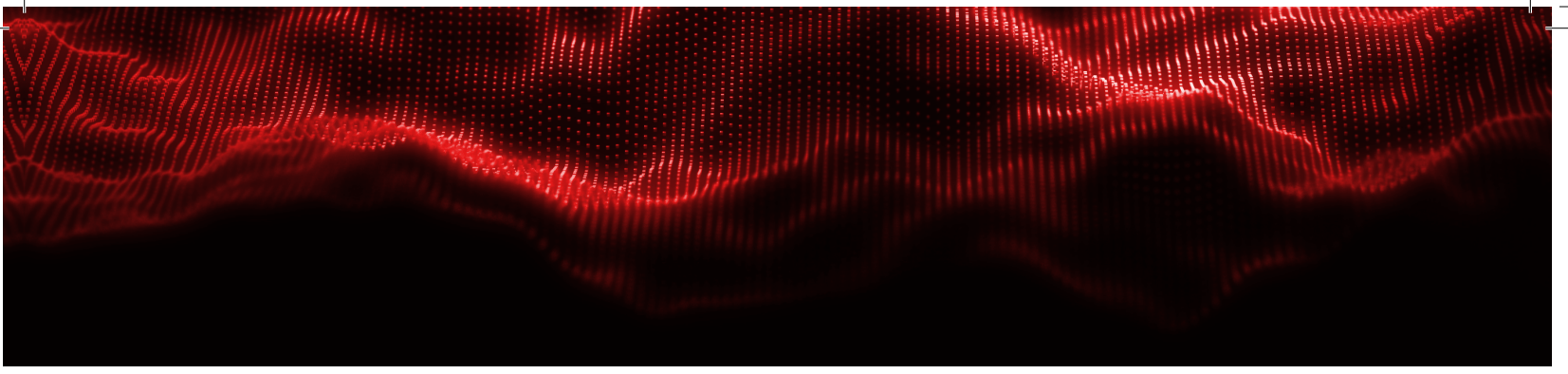

Your servicing Webb approved dealer will stamp & date the below relevant sections, when the correct service actions have been completed.

PLEASE ENSURE THE SERVICE BOOK IS AVAILABLE FOR THE DEALER, DURING SERVICE WORK.

1st Service

This must be stamped by an approved service dealer to qualify for a free second year warranty.
(Excluding the Webb Electric Handheld machines)

12 Months

Date

24 Months

Date

36 Months

Date



X-SERIES

INSTRUCTION MANUAL

48 Months

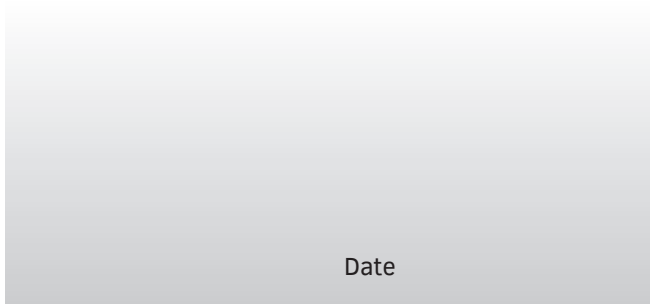

60 Months

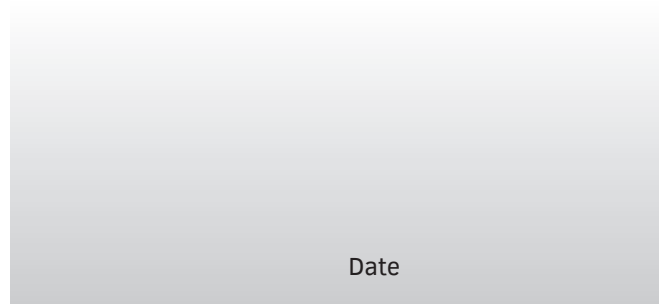

72 Months

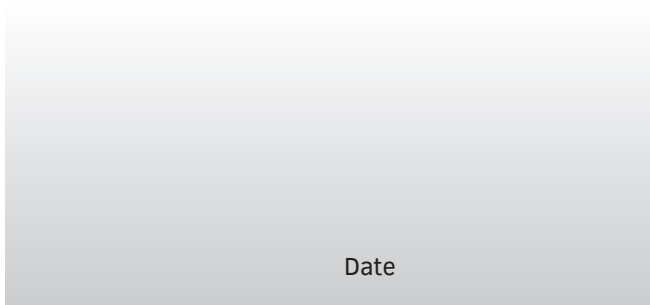

84 Months

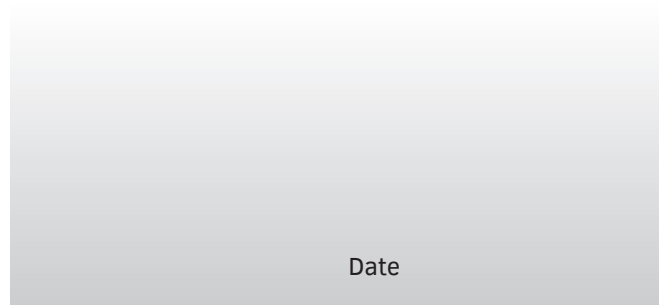

96 Months

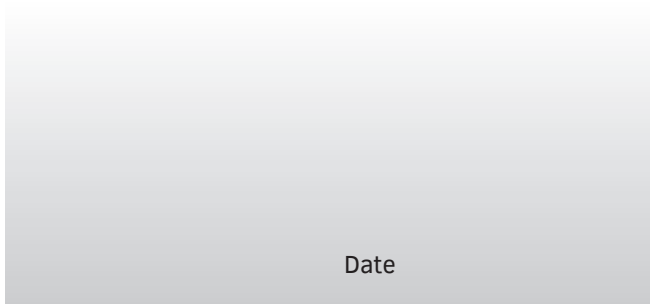

108 Months

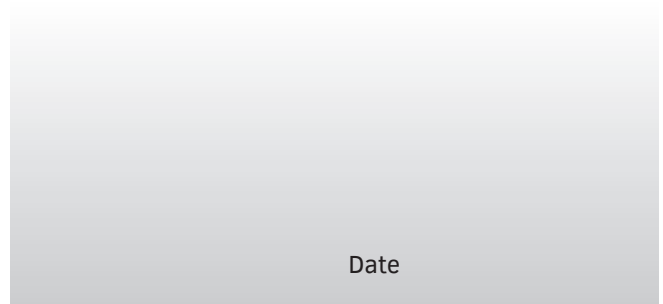

120 Months

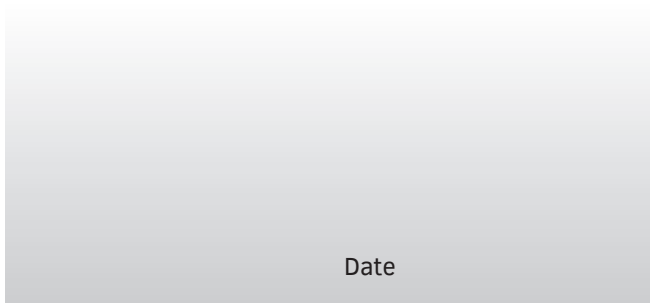

132 Months

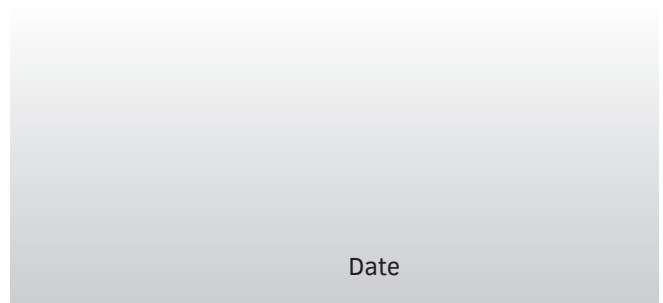

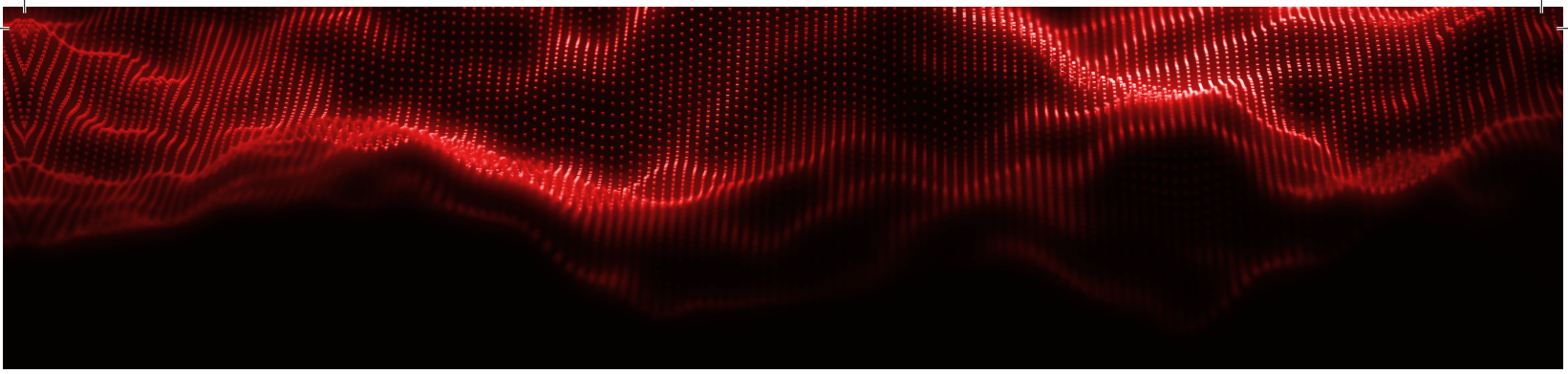

Product Information (* Compulsory)

If you have registered online, this form is not necessary.
PLEASE POST THIS COPY TO THE ADDRESS OVERLEAF

*Model No:	
*Product No:	
*Serial No:	
*Date of Purchase:	

Personal Information (* Compulsory)

*Title		*Forename		*Surname	
*House Number		*House Name			
*Address 1					
*Address 2					
*Town					
*County					
*Postcode					
Home Tel				Mobile Tel	
Email					

Age	18 to 25		26 to 35		36 to 45		46 to 60		61 to 80		81 & over	
*Usage	Domestic Use				Commercial/Professional/Hire Use							

*Dealer Stamp (if available)



*Selling Retailer (If dealer stamp not available)

*Dealer Name	
*Dealer Address	
*Date of Purchase	

Webb Lawnmowers privacy commitment to machine owners.

The information supplied, helps us to improve the products & services we provide, including information that we believe is relevant to your and/or your machine. We value your trust by giving us this information about yourself and we are committed to protecting your privacy.

Webb, its associated companies, authorised dealers or third parties working on our behalf may wish to contact you regarding **PRODUCT RECALLS** specific to your machine. Please advise how you wish to be contacted for this specific reason only:

Post Telephone Email

From time to time Webb, its associated companies, authorised dealers or third parties working on our behalf may wish to contact you regarding our products, services, offers or just opinions, which may be used for marketing, research or analysis purposes.

If you wish to be contacted by any of the following methods, please tick the relevant boxes:

Post Telephone Email

You may give Webb Lawnmowers notice in writing at any time that you no longer wish to receive direct marketing communications

Webb[®] eco

X-SERIES

Service & Support: cs@webbgardenpower.co.uk

Webb, Murdock Road, Dorcan
Swindon, Wiltshire SN3 5HY

New cordless garden machinery range from



ADVANCED 40V BATTERY TECHNOLOGY