

Power Rotary Scissors

PRS-231M

*Brushcutter
Attachment*

Installation and Operation Instructions

- GB **ENGLISH**
(Original instructions)
- FR FRANÇAIS
- DE DEUTSCH
- IT ITALIANO
- ES ESPAÑOL
- NL Nederlands
- DK Dansk

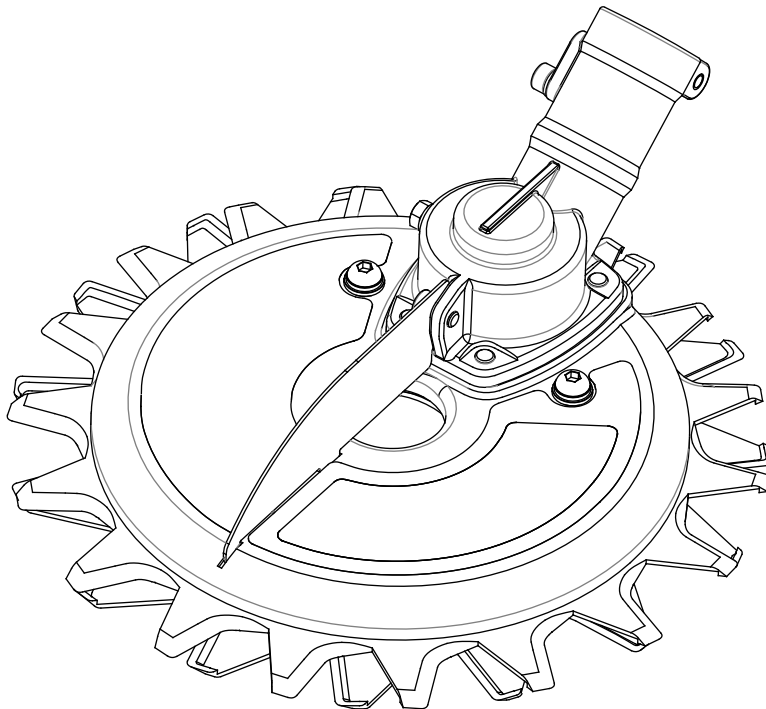

ECHO®

GB

Read and understand this manual before using this product.

Check the brushcutter

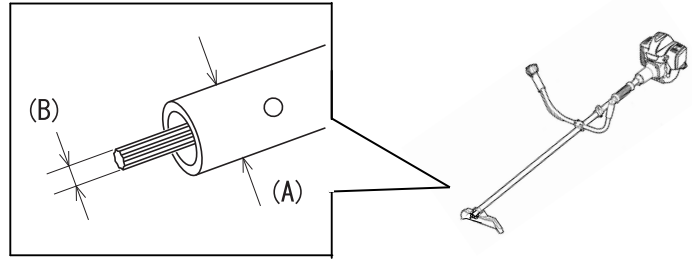

Power Rotary Scissors can be attached to the brushcutter in the table on the right



(See pages 4~5)

(A) Outer tube diameter (mm)	(B) Drive shaft shape		
	Diameter (mm)	No. of teeth	Teeth shape
φ 24 mm	6	10	Spline
φ 25 mm	7	7	Spline
φ 25.4 mm	7	13	Serration
φ 26 mm	8	9	Spline
φ 28 mm	8	10	Serration
	□ 5.2	—	Square

Safety Precautions











Read the safety Precautions before use.

The precautions listed here are intended to prevent accidents or injury to the users of product or other people and ensure safe and proper use of the product.

-  **DANGER** This symbol calls attention to an act or a condition which will lead to serious personal injury or death of operators and bystanders.
-  **WARNING** This symbol calls attention to an act or a condition which can lead to serious personal injury or death of operators and bystanders.
-  **CAUTION** This symbol indicates a potentially hazardous situation which may result in minor or moderate injury.

The item of CAUTION even has the potential which lead to serious result. These are important for safety, so make sure these are strictly obeyed.

Symbols

Symbol shape	Symbol description	Symbol shape	Symbol description
	Carefully read the operators manual.		Wear eye protection to protect the eye from flying debris and stones.
	Be careful not to touch the blades. The blades are sharp and may cause serious injury.		Wear ears protection to avoid hearing impairment.
	Beware of high-temperature areas.		Wear protective helmet to protect the head from falling object.
	Warning, Thrown objects!		Protective gloves must be worn.
	Make sure that there are no people and animals around the work area.		Wear sturdy boots with nonslip soles. Steel toed safety boots are recommended.

DANGER!

Be careful not to touch the blades. The blades are sharp and may cause serious injury.

Read the manual of the brushcutter in advance.

WARNING!

Wear safety glasses while using the Power Rotary Scissors.

Wear gloves when handling the Power Rotary Scissors.
Be very careful of the blades.

Wear protective clothing for grass cutting work.

Wear sturdy boots with nonslip soles.

Be sure to attach the protector in the brushcutter.

Never use the Power Rotary Scissors after consumption of alcohol or drugs, or if feeling tired or ill.

Allow the Power Rotary Scissors to cool sufficiently after operation, before you touch it.
The Power Rotary Scissors heats up during operation due to the friction of the blade.

If a foreign object, such as a piece of wire becomes tangled in the Power Rotary Scissors stopping blade rotation, stop the engine first before removing the object.
If blade rotation is still not smooth after removing the object, see the "Maintenance" section of this manual (Page 8) for further troubleshooting information.

Please make sure that there are no children or other people within a working range of 15 meters, also pay attention to any animals in the working vicinity.

This product can reduce a flying stones. It does not mean not to fly at all.
Make sure the safety confirmation to the surroundings and wear safety glasses while using.

ATTENTION!

Use only for lawn and grass cutting.

To avoid malfunction or injury do not modify your Power Rotary Scissors.

Shield the blades with the protective cover when not in use.

The blades must be free and not touch anything while starting the brushcutter engine.

The Power Rotary Scissors is water resistant. However, if it is used in a wet area, wipe the blades and lubricate after each use.

Do not completely submerge the Power Rotary Scissors and the brushcutter in water.

Sharpen the blades if grass cutting efficiency drops.

See sharpening (page 6), maintenance (page 8).

Periodically lubricate the Power Rotary Scissors to ensure proper performance (See page 9).

Obstacles like plastic bags and steel wires in the grass should be removed before cutting the grass to prevent them from becoming entangled in the blades.

Do not hit the blade against obstacles. It will be caused damage to each part.
Also, there is a possibility that the blade and the bottom disk drop off, which is dangerous.

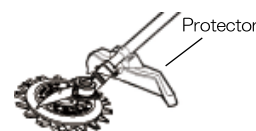
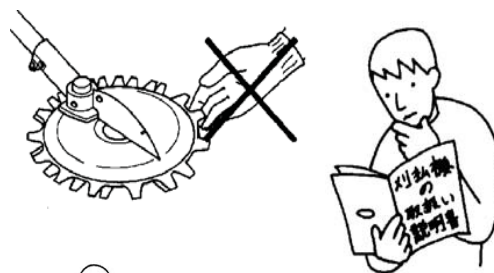

Danger!
Very Hot!

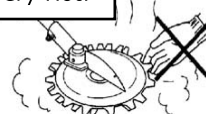

Stop the engine first



Blades off the ground for starting!

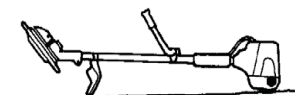

OK!



No!

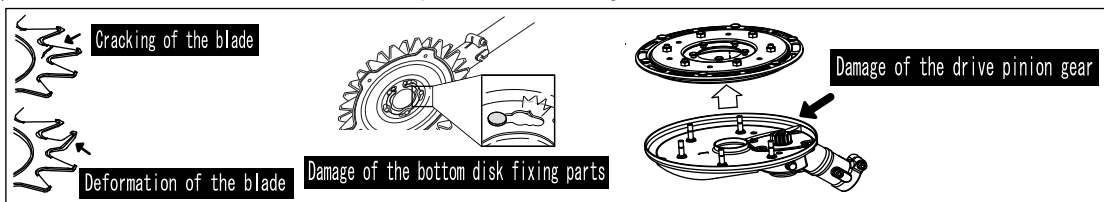
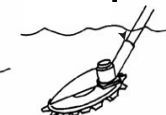



MOUNTING

Check the outer tube diameter

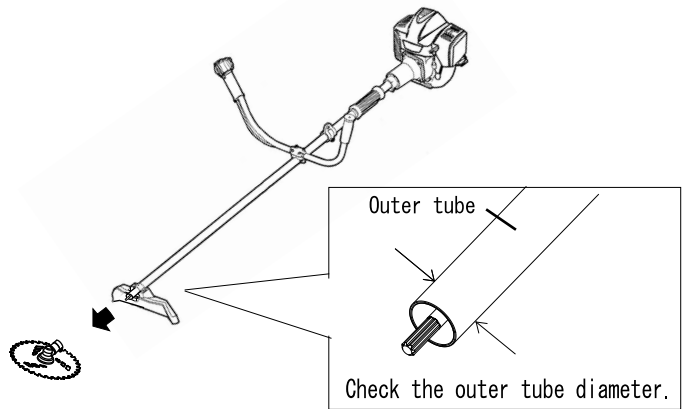
- ① Remove the existing gear case.
- ② Check the outer tube diameter.

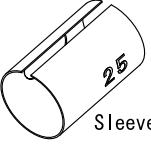

Select the sleeve

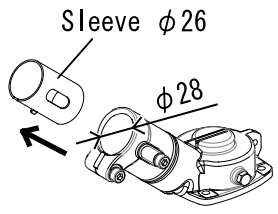
Outer tube diameter				
ϕ 24mm	ϕ 25mm	ϕ 25.4mm	ϕ 26mm	ϕ 28mm
 <p>Sleeve ϕ 24</p>	 <p>Sleeve ϕ 25</p>	 <p>Sleeve ϕ 25.4</p>	<p>Sleeve ϕ 26 is already in the gear case</p>	 <p>Sleeve ϕ 26</p> <p>ϕ 28</p> <p>Remove sleeve ϕ 26 from gear case</p>

Insert the sleeve into the gear case



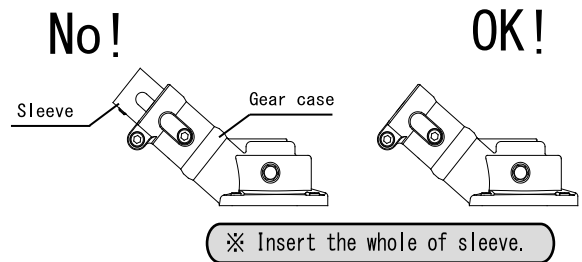
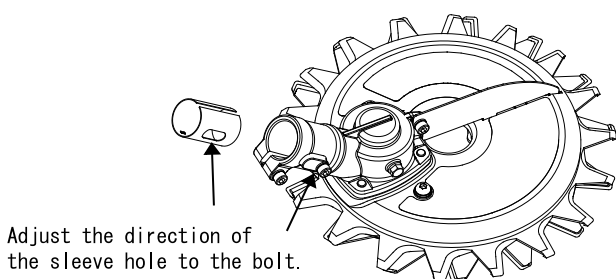
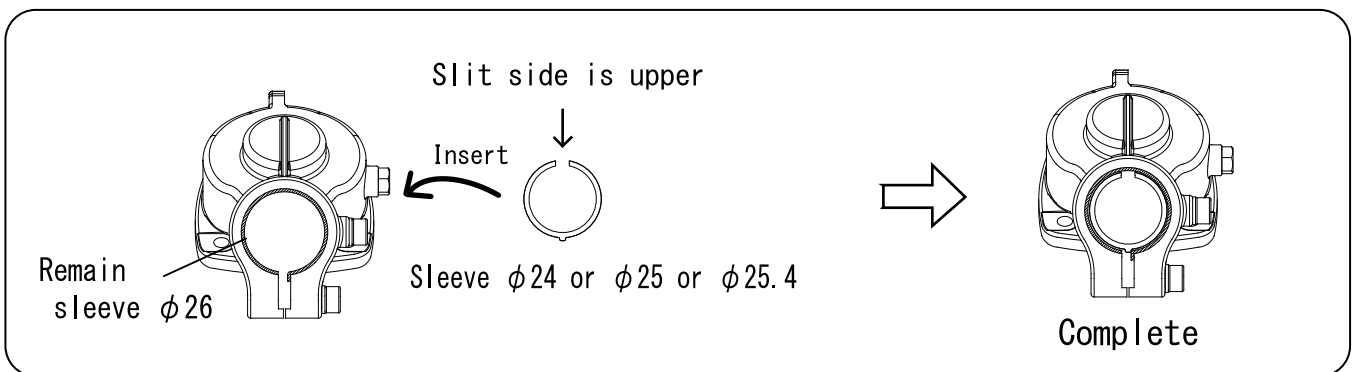



For outer tube diameter ϕ 24, ϕ 25, ϕ 25.4

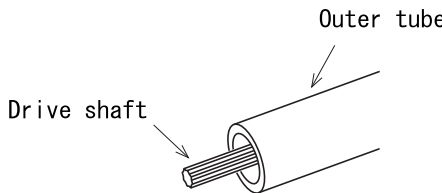

⚠ Be careful that if the sleeve is wrong mounting, the gear case is broken.

Select the adapter



Diameter (mm)	Drive shaft shape		Adapter
	No. of teeth	Teeth shape	
6	10	Spline 	Adapter 6-10
7	7	Spline 	Adapter 7-7
7	13	Serration 	Adapter 7-13
8	9	Spline 	Adapter 8-9
8	10	Serration 	Adapter 8-10
□ 5.2	—	Square 	Adapter S Q



※Check whether the shaft fit the hole of adapter.

Mount the selected adapter to the unit

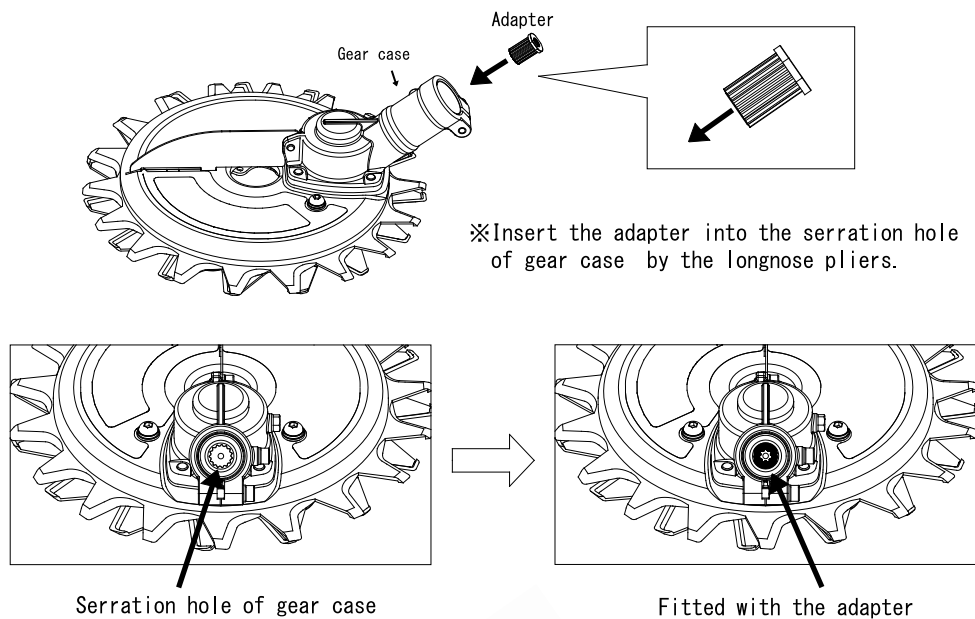

Install the Power Rotary Scissors

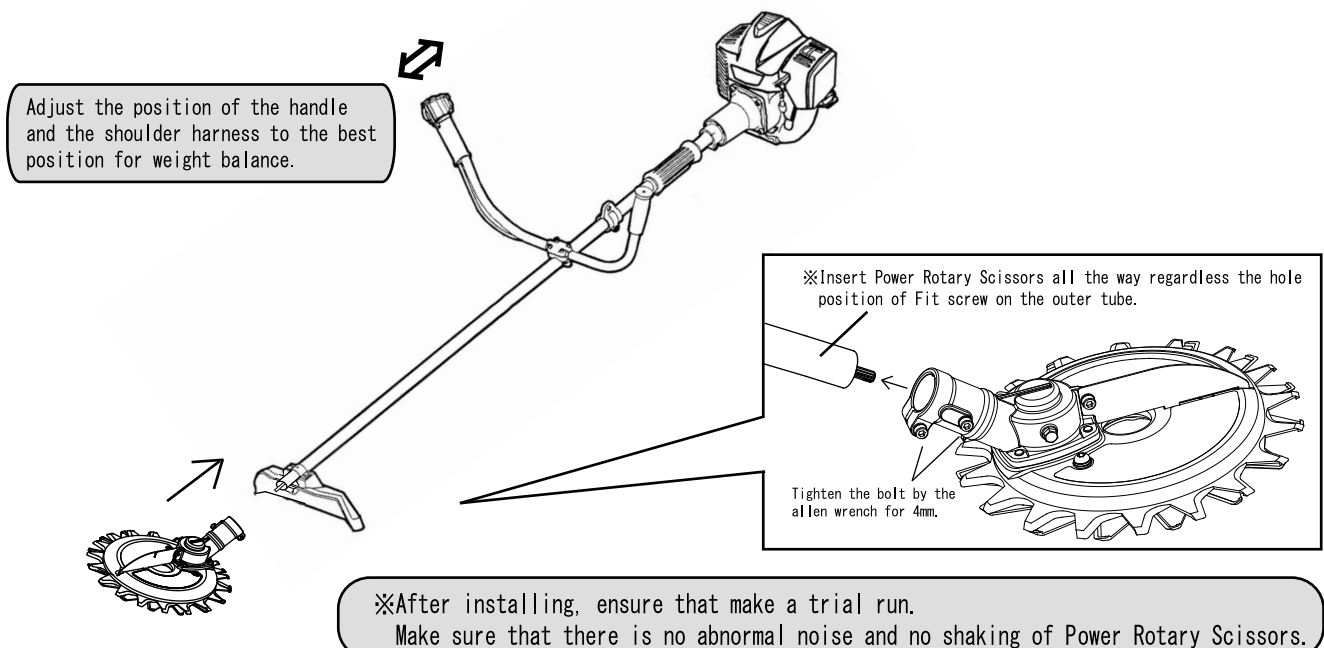

BLADE SHARPENING

Sharpen the blades when grass tends to stick to them.

WARNING

Stop the engine before sharpening the blades. Wear gloves to help prevent injury.

Blade sharpening

1. First remove the upper and lower blades.
(See pages 9 through 11 for removal and installation)
2. Sharpen the edge of the both upper and lower blades.
(See illustration) with a file.
 - Take care not to heat the blade enough to change the color. This may decrease blade hardness.
 - Sharpen the blade edge at 45 degrees.

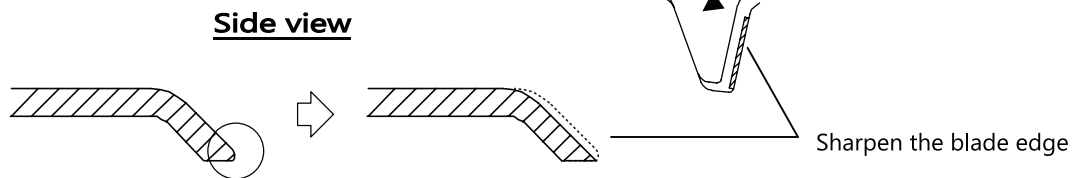

Timing for Blade Replacement and Blade Sharpening

1. It is suggested to sharpen the blades in every 8 to 10 hours of operation as a reference in case of cutting soft grasses or lawn.
2. It is also suggested to replace the blades in every 30 to 40 hours of operation including 3 to 4 times of blade sharpening.
3. Replace the blades if either upper or lower blade thickness has been worn to 2.7mm or less.
 - Referenced operating hours for blade sharpening differs depending on the type grasses, or cutting environments including obstacles like soil and sand.
 - Some grasses could be rolled up in the blades. If this happens, first remove the blades then remove completely the rolled grasses, as it could seriously affect the life of blades and main body.

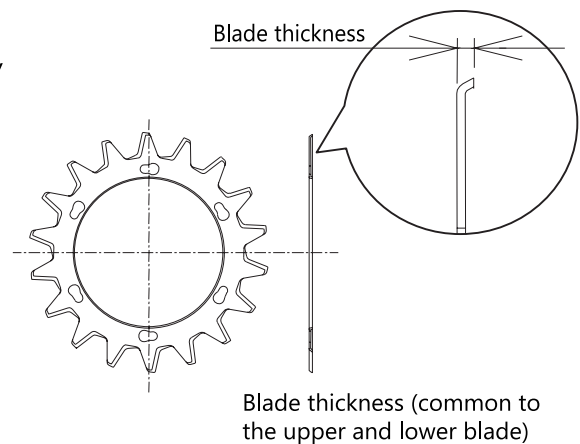

BLADE REPLACEMENT

WARNING

Make sure the engine is stopped before replacing the blades. Wear gloves to handle the blades.

*To replace the blade, exclusive long nose pliers or snap ring pliers is required.

1. Remove the bottom disc fixing bracket.
※ Be careful not to jump out the bottom disc fixing bracket while mounting it.

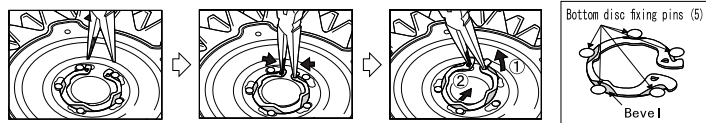

2. Remove the bottom disc.

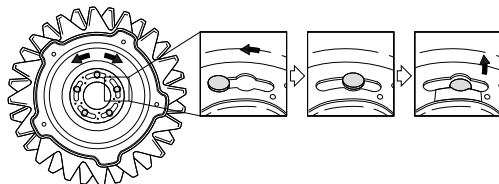

3. Remove the upper and the lower blades.

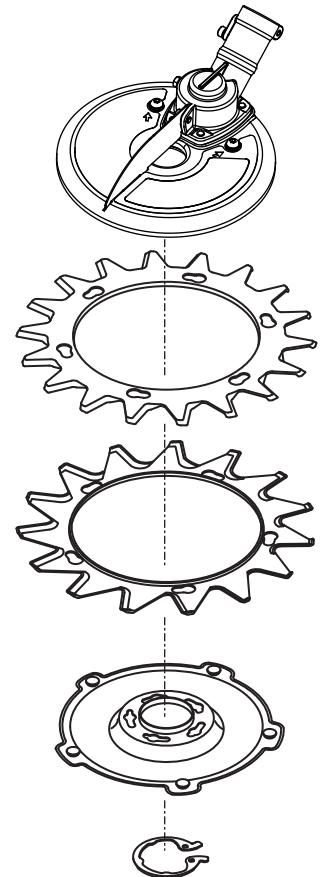
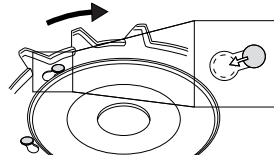

4. Clean up the body with a brush to remove grass and dirt and wash it with water.
5. Wipe the body and dry it. Then wipe it with an oily cloth before installing the blades.
6. Mount the upper and the lower blades.
7. Mount the bottom disc.
8. Mount the bottom disc fixing bracket.

MAINTENANCE



- * Make sure the engine is stopped before replacing the blades.
- * Wear safety glass and gloves to handle the blades.

Lower Blade

1. Clean the blades and bottom disc with a brush, to remove grass or dirt stuck to them.
See **Maintenance points** below for details.
2. Wipe the blades and bottom disc and dry them. Then, wipe them gently with an oily cloth. To install the blade, first position the blade holes on fixing pins, then turn the blade counterclockwise.
 - Take care not to install the blade upside down.
 - Make sure all the fixing pins are in place when the blade is installed.

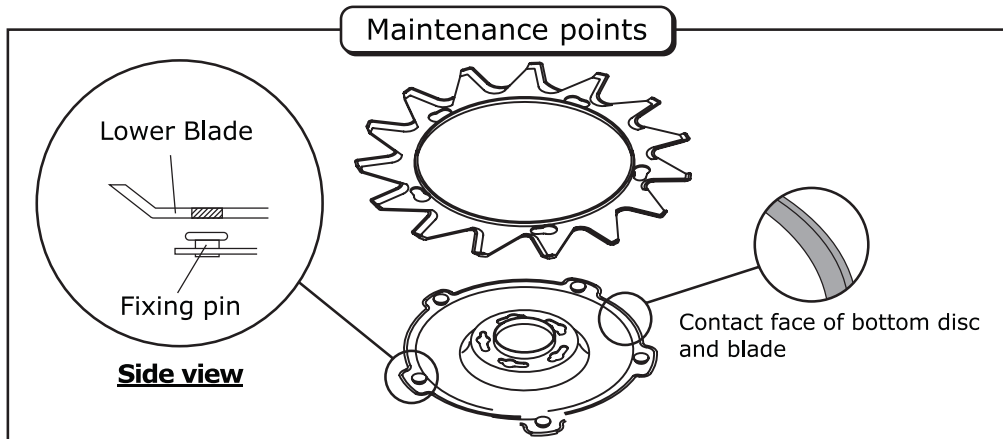

Upper Blade

1. Clean the blades and bottom disc with a brush, to remove grass or dirt stuck to them.
See **Maintenance points** below for more details
2. Wipe the blades and bottom disc, and dry them. Then, wipe them gently with an oily cloth.
3. Mount the blade by aligning the blade holes and fixing pins, then by turning the blade counterclockwise.
 - Take care not to install the blade upside down.
 - Make sure all the fixing pins are in place when the blade is installed.

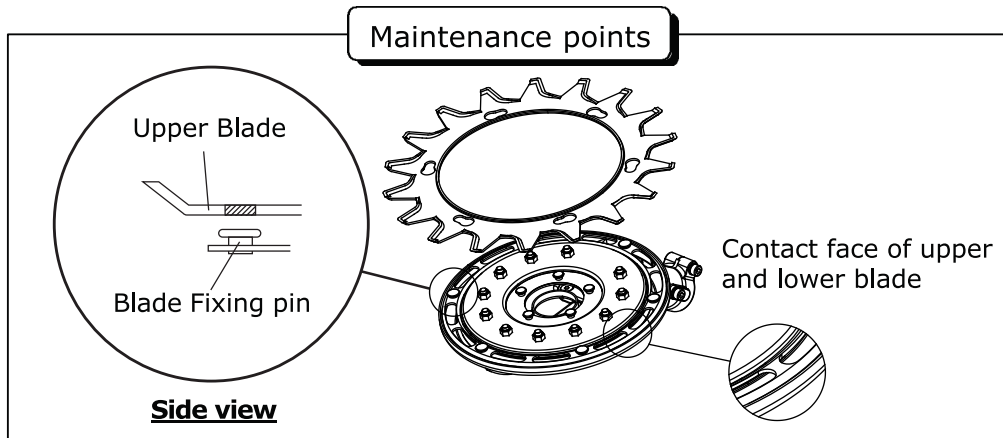

Lubrication

1 Remove the two screws to allow grease to be injected (see illustration), and inject grease into both screw holes. Inject about 20cc per every 10 hours of operation as a reference.

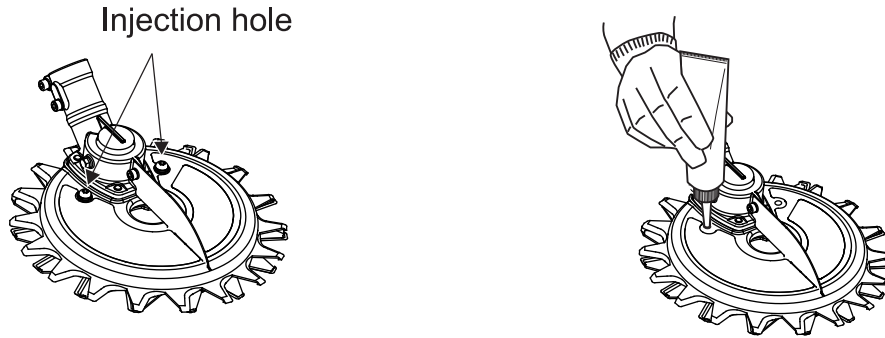

2 Insert the two screws and tighten securely.

3 Remove hex screw (M5×6) in the gear case, and inject about 10cc of grease into the hole every 25 hours of operation as a reference.

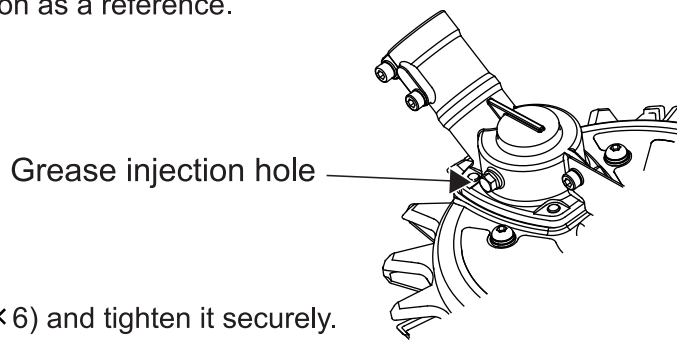

4 Insert the hex screw(M5×6) and tighten it securely.

This completes lubrication

* Lubricate the Power Rotary Scissors and oil the blades if it is to be stored for more than 30 days.

First aid relating to grease

Eye Contact:

- Immediately flush with water for at least 15 minutes. Get medical attention.

Skin Contact:

- Thoroughly remove with cloth or paper and wash carefully with soap and water.

Inhalation:

- Remove the victim from the contamination to fresh air. Cover the victim in a blanket to keep warm and quiet. Consult a physician.

Ingestion:

- Do not induce vomiting. Immediate consult a physician.

Notes to Physicians:

- Supportive care. Treatment based on judgment of the physician in response to reactions of the patient.

Specifications

Model	PRS-231M
Cutting method	Rotary scissor blades
Dimensions L × W × H (mm)	258 × 230 × 101
Diameter (mm)	φ 230
Weight (kg)	1.8
Max engine speed (min ⁻¹)	10,000
Max engine performance (kW)	2.0

Surface	Aluminum (A5052)	
Reduction	Planetary gear reduction	
Ratio	Upper	1:18.8
	Lower	1:13.5

WARNING

Stop the engine before handling the unit. Wear gloves to handle the blades.

Status	Where to check	Solution	See Page
Blade does not turn or does not turn properly	Is the unit properly mounted?	Mount the unit properly.	4
	Any cracks or bends on the blades?	Replace the blade or blades.	7
	Any foreign objects caught in the blades?	Remove the objects.	8
	Is the product properly lubricated?	Inject grease periodically.	9
	Does the brushcutter engine function properly?	Check all engine functions.	
Abnormal noise or Abnormal vibration	Any foreign objects caught in the blades?	Remove the objects.	8
	Any cracks or bends on the blades?	Replace the blade or blades.	7
	Are the upper and lower blade properly mounted?	Check the blade mounting.	7
	Is the product properly lubricated?	Inject grease periodically.	9
	Is the product properly mounted to the brushcutter?	Check the mounting.	4
	Is the brushcutter drive shaft bent?	Check the brushcutter .	
Dull blade cutting	Any cracks or bends on the blades?	Replace the blade or blades.	7
	Blade wear?	Sharpen the blade.	6
	Is the engine speed correct?	Adjust the engine speed properly.	

For European countries only

EC Declaration of Conformity

We, YAMABIKO CORPORATION declare in our sole responsibility that the following product conforms to all the relevant provisions.

Product Name : Power Rotary Scissors
 Model Name : PRS-231M

Council Directives : DIRECTIVE 2006/42/EC OF THE EUROPEAN PARLIAMENT AND OF THE COUNCIL of 17 May 2006 on machinery, and amending Directive 95/16/EC

Applicable Harmonized : Machinery Directive, EN ISO 12100 : 2010
 Standards EN ISO 11806-1 : 2011

the requirements of Directive 2011/65/EU (use of harmonized standard EN 50581:2012)

Masayuki Kimura
 General Manager
 YAMABIKO CORPORATION
 7-2 SUEHIROCHO 1-CHOME, OHME,
 TOKYO 198-8760, JAPAN

Masayuki Kimura

The authorized representative in Europe who is authorized to compile the technical file.
 Company: CERTIFICATION EXPERTS B.V.
 Address: Stationsplein 30, 1382AD Weesp, The Netherlands
 Mr. Richard Glaser



GB

YAMABIKO CORPORATION

7-2, SUEHIROCHO 1-CHOME, OHME, TOKYO, 198-8760, JAPAN
PHONE :81-428-32-6118. FAX:81-428-32-6145