

HYUNDAI
POWER PRODUCTS

PETROL BRUSH CUTTER HYBC5200X

User Manual

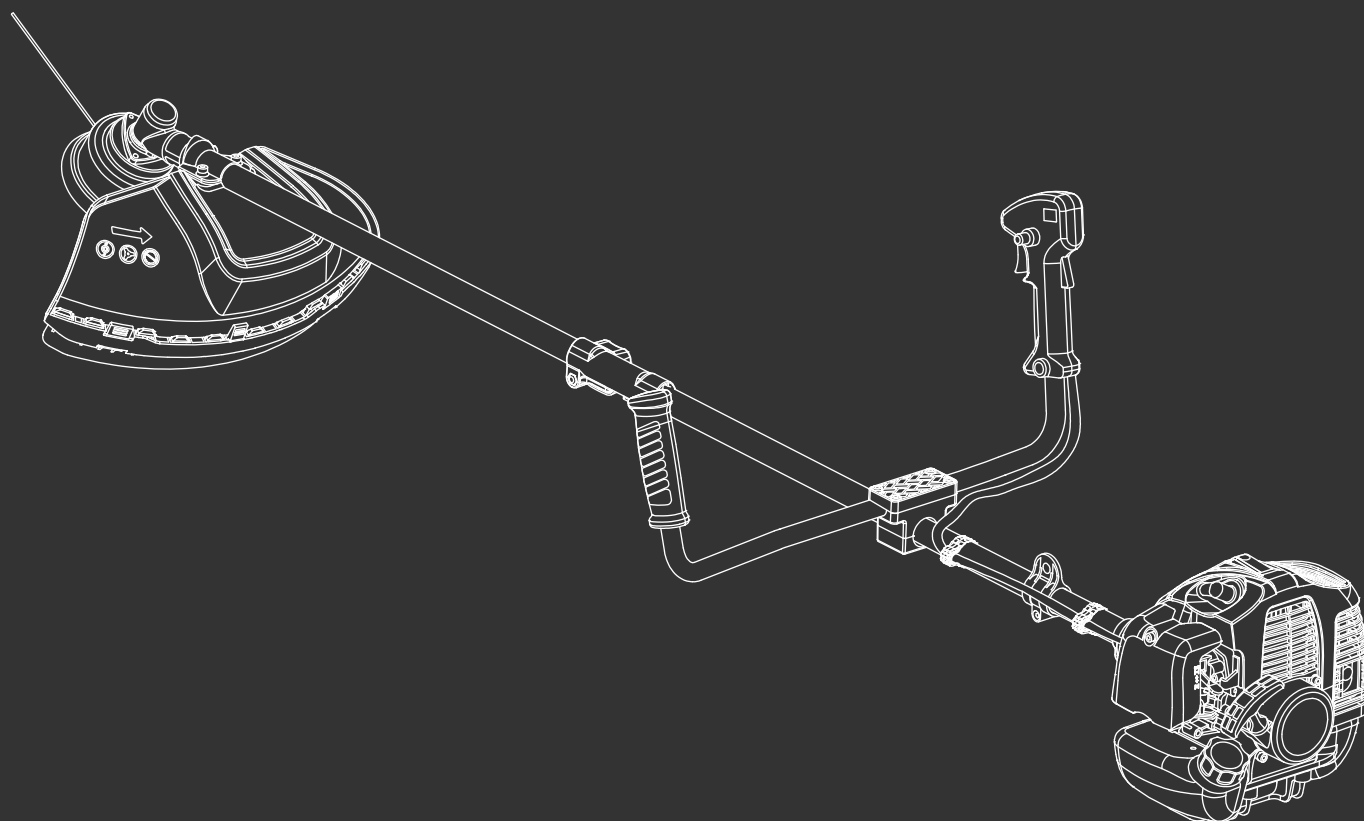

CONTENTS

1.	SAFETY	4 - 8
2.	QUICK START	9 - 21
3.	STARTING PROCEDURE	22 - 24
4.	STOPPING PROCEDURE	24
5.	USING THE MACHINE	25 - 26
6.	MAINTENANCE	27 - 30
7.	TROUBLESHOOTING	31
8.	SPECIFICATION	32
9.	PART LOCATIONS	33 - 34
10.	DECLARATION OF CONFORMITY	35
11.	RECYCLING & PRODUCT DISPOSAL	36
12.	CONTACT DETAILS	36
13.	MANUAL UPDATES	36
14.	WARRANTY	37

1. SAFETY

1.1. General safety notes.

1.1.1. The operator of the machine is responsible for, and has a duty of care in making sure that the machine is operated safely and in accordance with the instructions in this user manual. Keep the manual safe and pass it on if the machine is loaned or sold to another user.

1.1.2. Please note the following safety points.

1.1.2.1. The machine should never be left in a condition which would allow an untrained or unauthorised person/s to operate this machine.

1.1.2.1.1. All due care and diligence should be taken by the operator for the safety of, and with regard to, those around whilst using the machine.

1.1.2.1.2. Some or all of the following - warning signs, symbols and/or PPE pictograms may appear throughout this manual. You MUST adhere to their warning/s. Failure to do so may result in personal injury to yourself or those around you.

DANGER

Indicates a hazard, which, if not avoided, could result in serious injury or death.

WARNING

Indicates a hazard, which, if not avoided, could result in serious injury.

CAUTION

Indicates a hazard which, if not avoided, might result in minor or moderate injury.

NOTE

Indicates a situation that could easily result in equipment damage.



READ and keep the manual safe and pass it on if the machine is loaned or sold to another user. You MUST fully read instructions to make sure you use and operate machine safely.

Appropriate Personal Protective Equipment (PPE), MUST be worn at all times when Machine is in use or being repaired.



⚠ DANGER!

BREATHING IN CARBON MONOXIDE FUMES CAN KILL YOU!
To help protect against CO poisoning install a Carbon Monoxide detector.

NEVER use Petrol/Diesel powered equipment inside, especially a home, garage, tent, camper-van, caravan, motorhome or boat.
EVEN if doors, windows, vents and hatches are open. Only use **OUTDOORS** and as far away from doors, windows, vents and open hatches as possible to prevent inhaling fumes.

READING MANUAL BEFORE USE WILL HELP AVOID OTHER MACHINE HAZARDS.

1.2. Carbon monoxide (where applicable).

1.2.1. Carbon monoxide is a colourless and odourless gas. Inhaling this gas can cause death as well as serious long term health problems such as brain damage.

1.2.2. The symptoms of carbon monoxide poisoning can include but are not limited to the following; Headaches, dizziness, nausea, breathlessness, collapsing or loss of consciousness.

1.2.2.1. Carbon monoxide poisoning symptoms are similar to flu, food poisoning, viral infections and simply tiredness. It is quite common for people to mistake this very dangerous poisoning for something else.

1.2.2.2. To avoid carbon monoxide poisoning DO NOT use Petrol/Diesel- powered equipment inside any of the following; Home, garage, tent, camper van, mobile home, caravan or boat.

This list is not exhaustive and if you are in any doubt contact your dealer.

1.2.3. If you think you have or someone around you has been affected by carbon monoxide poisoning;

1.2.3.1. Get them fresh air immediately, by leaving the affected area or by opening doors and windows. If safe and practical to do so

make sure that the machine is turned off. DO NOT enter a room you suspect of having carbon monoxide present – instead call the emergency services.

1.2.3.2. Contact a doctor immediately or go to hospital - let them know that you suspect carbon monoxide poisoning.

1.2.4 DO NOT use in an enclosed area or a moving vehicle.

1.3. General fuel safety (where applicable).



ALL FUELS ARE FLAMMABLE

1.3.1. Fire hazard - keep fuel away from all sources of ignition for example heaters, lamps, sparks from grinding or welding.



Fire Hazard

1.3.2. DO NOT carry out hot work on tanks that have contained fuel it is extremely dangerous.

1.3.3. ALWAYS keep work area clean and tidy.

1.3.4. ALWAYS clean up all spills promptly using correct methods i.e. absorbent granules and a lidded bin.

1.3.5. ALWAYS dispose of waste fuels correctly.

1.4. Fueling/De-fueling (where applicable).



ALL FUELS ARE FLAMMABLE

1.4.1. ALWAYS fuel and defuel in a well-ventilated area outside of buildings.

1.4.2. ALWAYS wear correct, suitable and fit for purpose Personal Protective Equipment (PPE), suggested items are but not limited to safety gloves and overalls.



1.4.3. When fueling/de-fueling ALWAYS avoid inhaling fumes

1.4.4. When de-fueling ALWAYS use a propriety fuel retriever.

1.4.5. ALWAYS carry fuel in the correct and clearly marked container.



Fire Hazard

1.5. Electrical safety (where applicable).



Risk of electric shock

1.5.1. Electricity can kill - NEVER work on LIVE/ENERGISED equipment.

1.5.2. Prior to carrying out any maintenance work you MUST Identify electrical isolation methods and isolate all electrical supplies,

1.5.3. Prior to use and with all electrical supplies isolated You MUST check all electrical cables, plugs and connections for the following;

1.5.3.1. Are intact and have no signs of damage, to include but not limited to bare wires, chaffing, cuts and loose wiring.

1.5.3.2. If there are any signs of damage, the damaged item MUST be taken out of service until the damage has been repaired by an electrically competent person.

1.5.3.3. All trailing cables should be routed so as not to cause any kind of trip hazard.

1.5.3.4. NEVER work on or near electricity with wet hands, wet clothing, and wet gloves.

1.6. Batteries (where present).



Corrosive

1.6.1. Batteries present a risk if they become damaged by the possible leaking of electrolyte. This electrolyte is an acid and can cause serious burn injuries. Care should be taken when working on or near them. NOTE the electrolyte may be in liquid or gel form.

1.6.2. Should you come into contact with electrolyte you should;

1.6.2.1. Remove all clothing contaminated with electrolyte. If you cannot remove then saturate in water.

1.6.2.2. Get medical assistance as soon as possible. You must advise the medical staff of the type acid.

1.6.2.2.1. Lead/acid battery = dilute sulphuric acid

1.6.2.2.2. Nickel/cadmium = potassium hydroxide alkali electrolyte.

1.6.2.3. Use fresh running water to wash off excess electrolyte, continue this until medical assistance arrives. Make sure that you do not wash the electrolyte to another part of the face or body.

1.6.2.4. If electrolyte comes into contact with Eyes the electrolyte needs to be immediately washed away with large amounts of water. Make sure that you do not wash the electrolyte to another part of the face or body.

1.6.3. Gasses from charging batteries are highly flammable and great care should be taken to charge in well ventilated areas.

1.6.4. There is an explosion risk if the battery terminals are short circuited, when connecting/dis-connecting ALWAYS exercise great care so that the terminals or battery leads are NOT allowed to touch and cause a spark. ALWAYS use suitable insulated tools.



1.7. Vibrations (where applicable).

1.7.1. Prolonged use of hand held (operated) machines will cause the user to feel the effects of/from vibrations. These vibrations can lead to white finger (Raynaud's phenomenon) or carpal tunnel syndrome. This condition reduces the ability of the hand to feel and regulate temperature, causing numbness and heat sensations and may cause nerve damage

1.9. Additional safety labels.

Keep all children, bystanders and helpers 15

and circulatory tissue death.

1.7.2. Not all factors that lead to white finger disease are known, but cold weather, smoking and other diseases that affect blood vessels and blood circulation as well as large and long-lasting impact of shocks are considered factors in the formation of white finger. Note the following to reduce the risk the white finger and carpal tunnel syndrome:

1.7.2.1. Wear gloves and keep your hands warm

1.7.2.2. Take regular breaks

1.7.3. All of the above precautions may help reduce the risk of white finger disease but not rule out carpal tunnel syndrome. Long-term and regular users are therefore recommended to observe the condition of your hands and fingers. Seek medical attention immediately if any of the above symptoms should occur.

1.8. Noise (where applicable).

1.8.1. The operating noise of the machine can damage your hearing. Wear hearing protection such as earplugs or ear defenders to protect your hearing. Long-term and regular users are advised to have hearing checked regularly. Be especially vigilant and cautious when wearing hearing protection because your ability to hear alarm warnings will be reduced.

1.8.2. Noise emissions for this equipment is unavoidable. Carry out noisy work at approved times and for certain periods. Limit the working time to a minimum. For your personal protection and protection of people working nearby it is also advisable for them to wear hearing protection.

1.8.3. See CERTIFICATE of CONFORMITY section for Outdoor Noise declaration of conformity.



meters from the machine.



Warning against flying objects wear helmet, goggles and ear protection.



Warning: Danger from hot components, especially exhaust - Keep clear of combustible materials.



1.10. Additional safety instructions.

1.10.1. This machine may only be used for trimming grass, weeds and brushwood. Never use for other purposes, as this may result in serious injury! Safety instructions must be observed. **DO NOT EXPOSE YOURSELF OR OTHERS TO THE RISKS.** Follow these general instructions -

- ALWAYS wear safety goggles for eye protection.
- Long hair must be tied back.
- DO NOT wear loose clothing or jewelry that could get caught in moving parts of the machine. Safe, strong, non-slip safety shoes should be worn.
- It is recommended that the legs and feet are fully protected, to protect themselves during the operation against flying objects.

1.10.2. Check the entire machine for loose/missing parts (nuts, bolts, screws, etc.). Tighten/ replace before using the machine. **DO NOT** use accessories with this machine other than those recommended/supplied by the manufacturer. Otherwise serious injuries to the user or bystanders as well as damage to the machine will result.

- Keep the handles free of oil and fuel.
- ALWAYS use the correct interface handles and shoulder strap.
- DO NOT smoke when mixing fuel or when filling the tank.

- DO NOT mix fuel in an enclosed area or near open fires.
- Make sure sufficient ventilation / ventilation.
- Mix and store the fuel mixture in a correctly marked container, which is allowed by local regulations.

1.10.3. During and after use the engine and exhaust will be very HOT you must keep all your all parts of your body and clothing including all combustible materials clear of the engine and exhaust.

1.10.4. DO NOT use the machine during or after rain, snow or sleet. The floor will become slippery. DO NOT use the machine on a slope or uneven ground or if there is the chance of slipping or losing the stability.

1.10.5. If you trip or fall whilst machine is in use you **MUST** immediately release the throttle, and turn off the ignition switch.

1.10.6. If you hit any obstacles you must stop the machine and remove the HT lead so that you can inspect the machine. IF the machine is damaged in any way you **MUST** get it repaired before restarting work.

1.10.7. DO NOT use a damaged machine or a machine with a blunt, cracked or damaged cutter blade or trimmer head.

1.10.8. When using the blade cutter there is a danger of kickback. Kickback is a reaction that can occur when the rotating cutting blade strikes an object which cannot be cut. This contact causes the cutting blade to stop for an instant and then suddenly repel from the object taken with accelerated force. This reaction can be violent enough that the operator momentary loses control of the machine. A kickback can occur without warning when the cutter encounters an unseen obstacle when the blade is running. This is more likely in areas where it is difficult to properly check the material/area to be cut. For easy and safe cutting, cut the weeds/brush from right to your left.

1.10.9. If any trimmed materials get tangled in the nylon cord or cutting blade you **MUST** stop the machine and remove the HT lead. Only then can you clear any blockages.

1.10.10.  **DANGER**

NEVER use the machine with a saw blade attachment it is STRICTLY FORBIDDEN.

1.10.11. DO not use the brush cutter for trimming trees.

1.10.12. DO NOT wear rings and jewelry or loose, dangling clothing that could get caught in the machine. DO NOT wear footwear with unprotected toes and DO NOT work barefoot or without leg protection. In certain situations, you have to wear head protection.

2. QUICK START

2.1. This guide is meant to serve as a quick reference for operating your Hyundai brush cutter it is for convenience and the user should read the safety section first.

OUTDOOR USE ONLY.

This brush-cutter produces carbon monoxide - a poisonous, colourless & odourless gas that can cause death or serious injury. Petrol is highly flammable, always handle with extreme care and in a well ventilated area.

Always remove HT lead from spark plug when checking machine or changing parts.

2.2. This product includes, Main unit, Operators handle, Trimmer head, Bump feed nylon trimmer head, 3 tooth steel blade, 8 tooth steel blade, Full harness, Tool kit, 2-Stroke oil mixing bottle & User manual.

2.3. At this point, check that you have all of the included items listed above. If any are missing or damaged, call 01646 687 880 or email info@hyundaipowerproducts.co.uk.

2.4. Handlebar assembly.

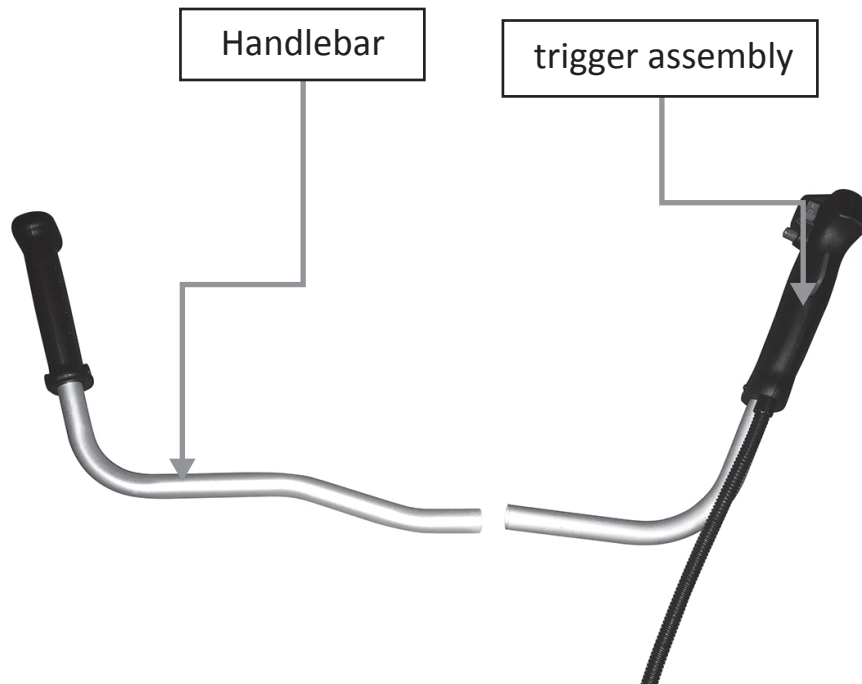

N.B. Note orientation of trigger assembly power switch should be towards user.



Undo the 4 Allen bolts and remove the cover, place handle bar into cradle and align hole in shaft and refit the four Allen bolts once positioned to suit user tighten the bolts.



Handlebar and trigger assembly

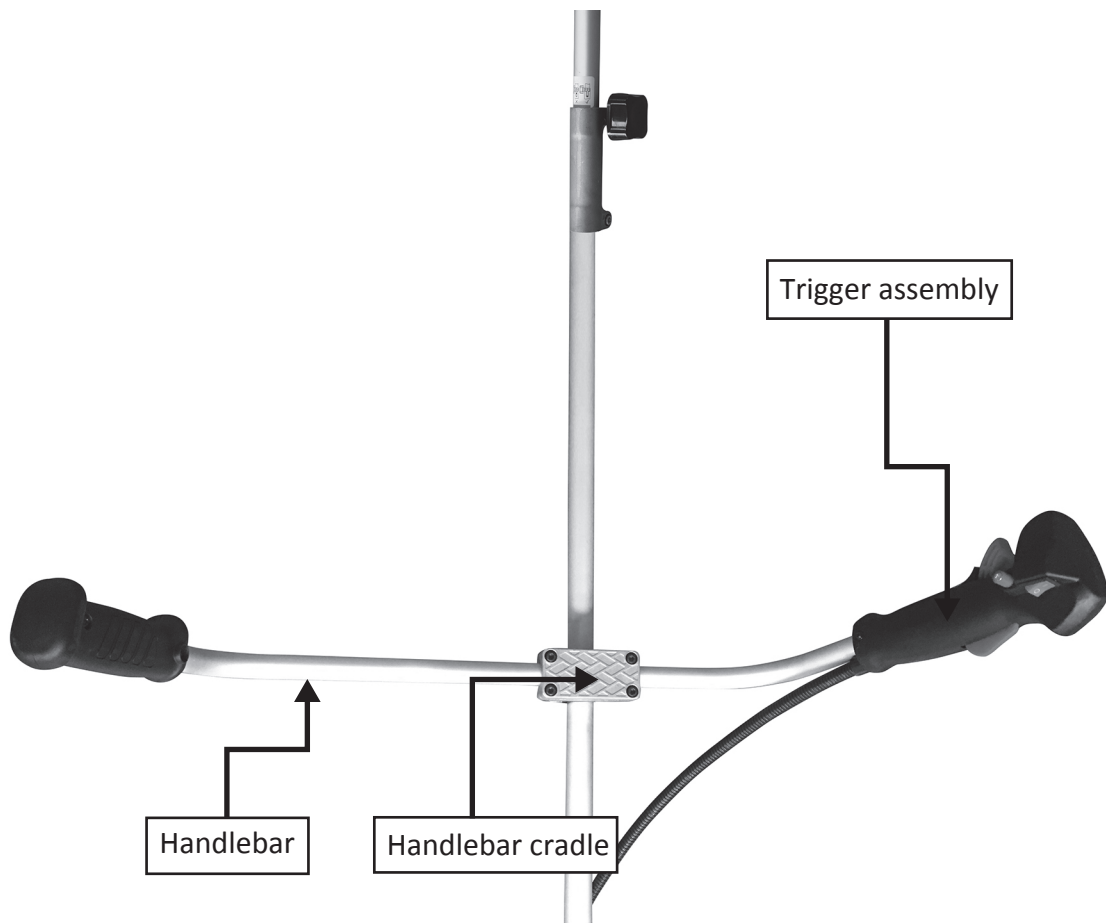

2.5. Trimmer blade assembly.

Before fitting the trimmer guard to the machine you must first fit the trimmer guard cord cutter. Take the cutter blade and 2 self-tapping screws from the Blue tool bag. Align the cutter blade as shown and fix into place. N.B. Keep the protective sleeve in place until blade is fully secured and ready for use.

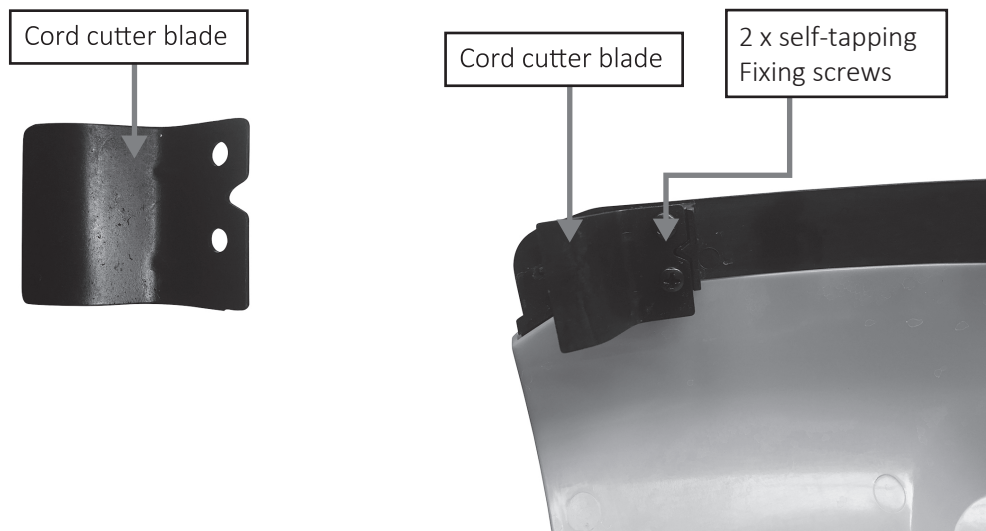

2.6. Trimmer guard assembly.

The trimmer guard needs to be fixed onto the lower shaft before it is mounted onto the machine. Take the trimmer guard clamp and 2 fixing Allen bolts from the tool bag then attach them to the trimmer guard. At this stage DO NOT overtighten the bolts.

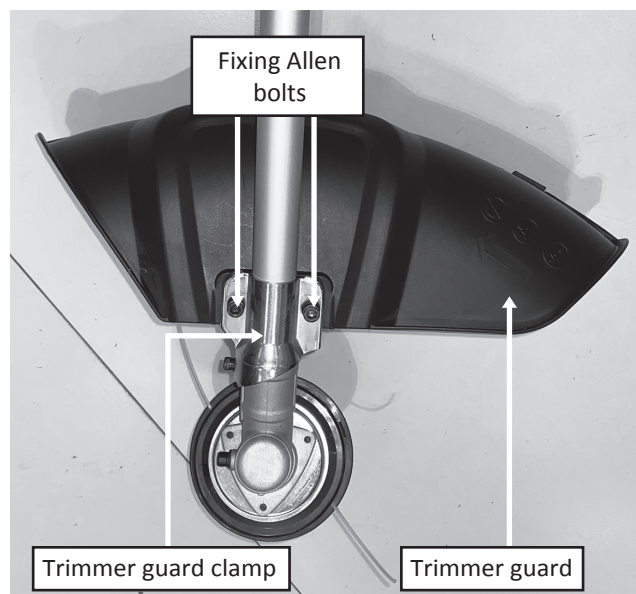

Place the semi assembled trimmer guard and slide it over the shaft as shown below. You will need to rubber bung of the end of the lower shaft – retain the bung for future use as it helps to keep the drive shaft clear and free of debris. Once the guard clamp has been located into the hole of the shaft tighten the two fixing bolts.

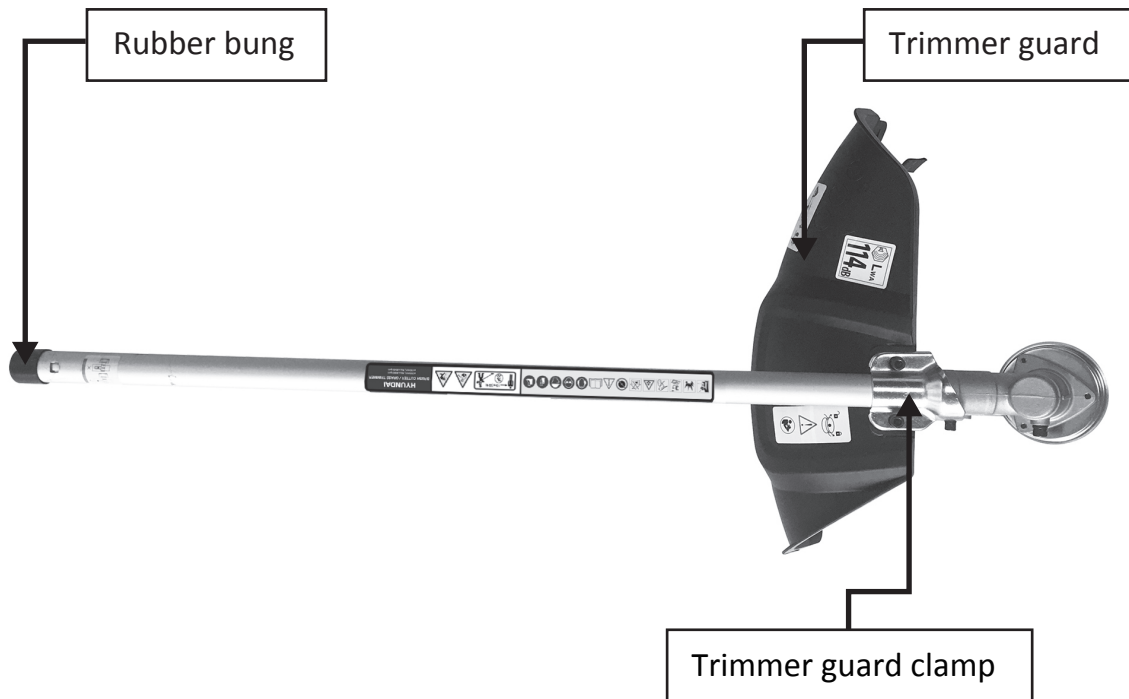

2.7. Grass trimmer assembly.

To fit the trimmer head you need to undo the retaining nut (clockwise direction), then remove the retention cup and the clamp plate (Keep these safe they are not used with the trimmer head).

Using one of the supplied 4mm Allen keys lock the shaft, then screw on the trimmer head in anti-clockwise direction make sure head is fully tightened.

Remove the Allen key before use.

To remove head reverse the process.

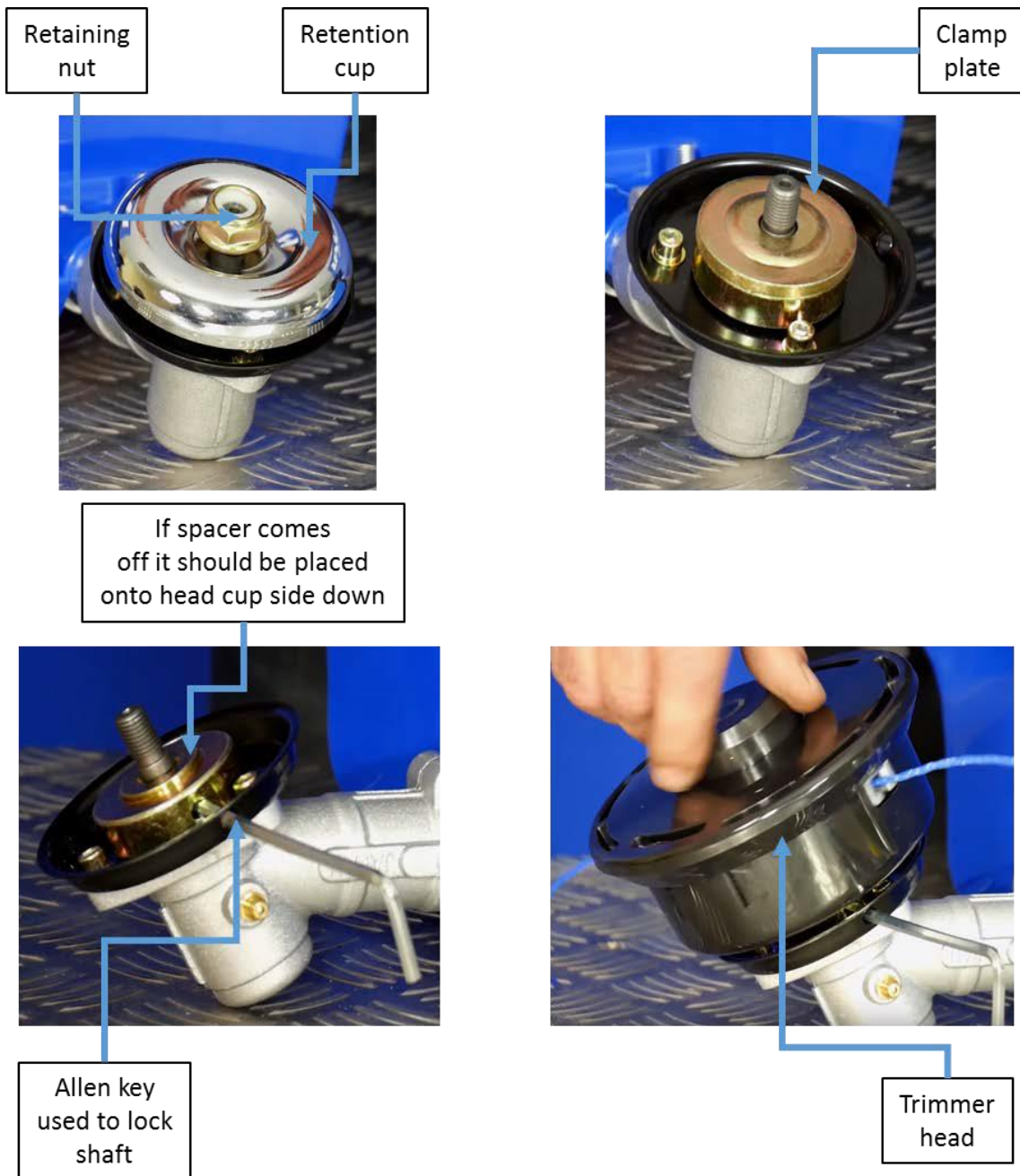

2.8. Cutter head assembly. (Machine is supplied with a 3 and 8 toothed blade).

2.8.1. You should wear safety gloves when handling the blades.

To fit the cutter blade you will need to remove the trimmer head.
Once the trimmer head is removed select either the 3 or 8 toothed blade.
Remove the plastic blade protective guard (retain for future use) and mount onto the shaft.
Fit drive spacer as below.

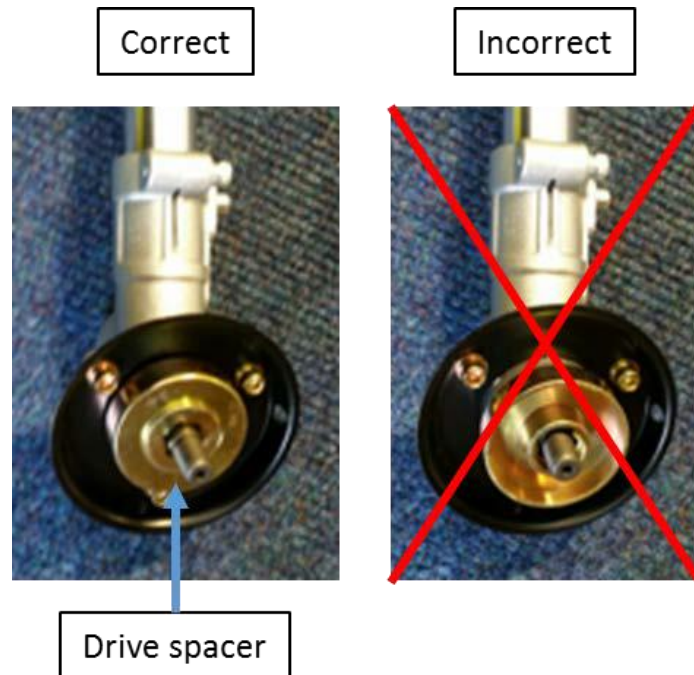

Fit blade. Make sure blade is correctly slotted onto shaft.

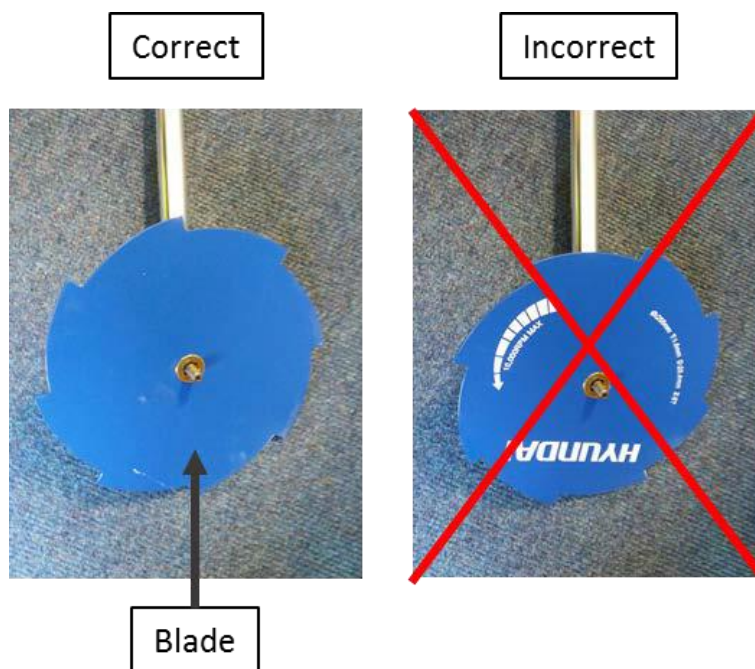

Fit clamp spacer.

Correct

Incorrect

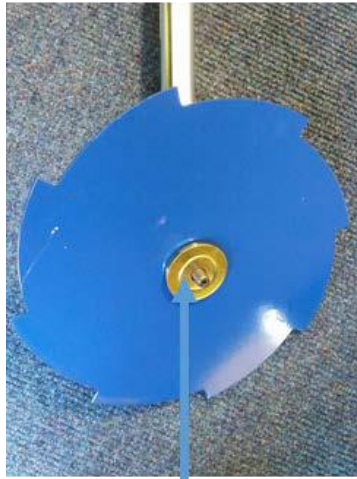

Clamp spacer

Fit cup spacer and securing nut. Lock the shaft as in section 2.7 and fully tighten. N.B. if machine vibrates excessively in use then STOP machine and make sure that the blades is correctly fitted – If in doubt contact Hyundai aftersales department.

Correct

Incorrect

Correct

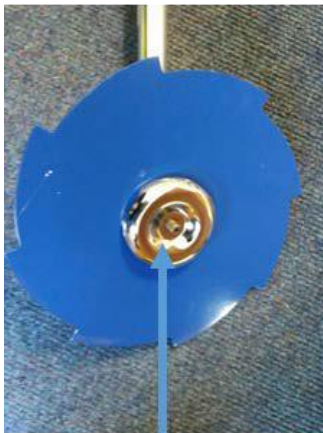

Retention cup

Securing nut

To fully tighten use the supplied spark plug box spanner. N.B. To tighten you need to turn box spanner in an anti-clockwise direction.



2.9. Attaching cutting assembly to drive shaft.

To attach the cutter assembly remove the protection bung (retain for future use) – undo the locking hand wheel, press the locking trigger and insert the cutter assembly into the drive assembly until it locates with the shaft. Once located the locking trigger will drop into place, pull shaft in outward direction to make sure it has locked. Once this is done tighten the locking hand wheel.

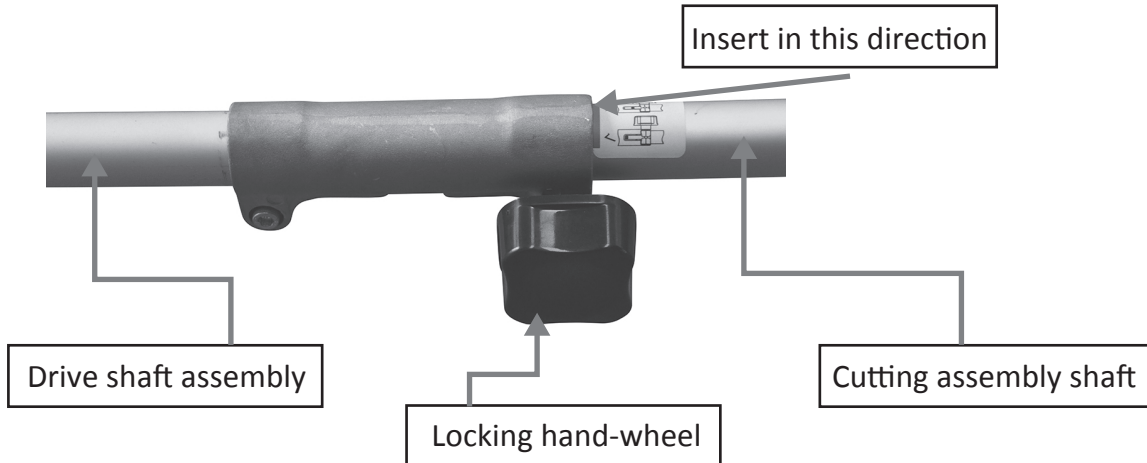

2.10. Head shield/Ear defender assembly (if included).

Rotate to align the tags on the helmet to match the holes on the top of the visor. Place the visor over the tags, then rotate the tags 180° to secure into place. Place the ear defenders over the outside of the headband on the helmet and place into the clips.



2.11. Mixing 2 stroke oil.

Fill the mixing bottle with fresh unleaded petrol to the fuel marker line use a 40:1 ratio. Then top up with 2 stroke oil to 40:1 ratio line shake until fuel/oil has mixed. **This machine will also run on Aspen2 pre-mix fuel.**

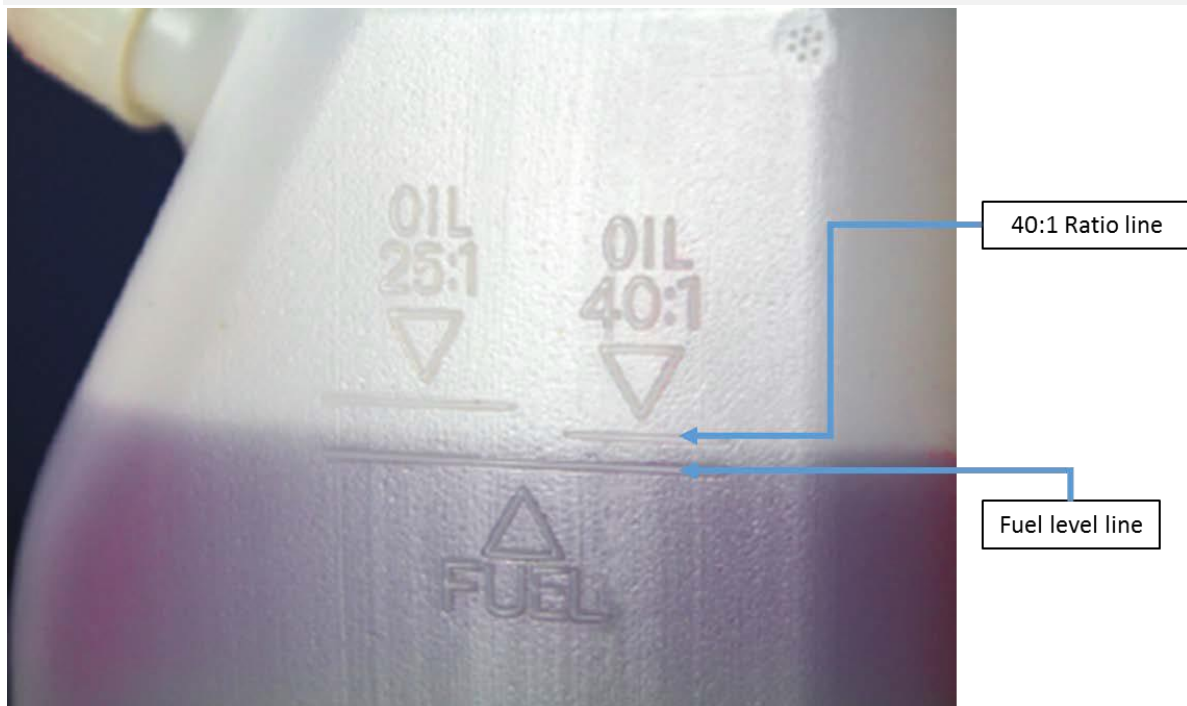

2.12. Adding fuel.

Unscrew the fuel tank cap and carefully add a 2-stroke fuel/oil mixture as in section 2.10. DO NOT overfill and allow a 25 mm gap at the top of the tank. Once full replace and correctly tighten the fuel cap. Fuel tank capacity is 1200ml.

DO NOT use straight unleaded petrol.

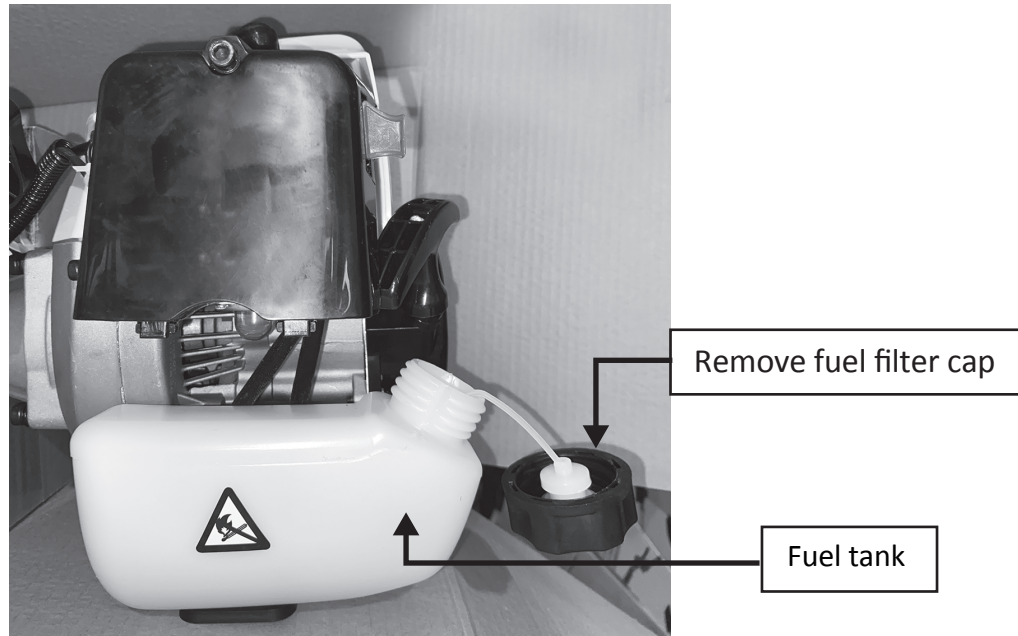

2.13. Fitting replacing spool line.

Squeeze the bump head unit either side on the grooves and pull to remove the top of the head. Remove the spool, spring and washer from the spindle.

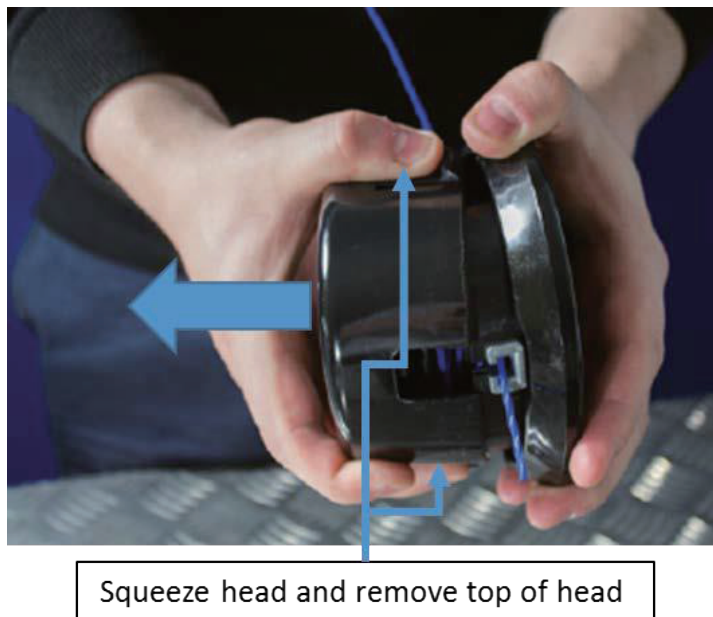

With the bump feed facing outwards from your left hand, take the looped end and place it around the holder in the middle of the spool as shown below.

You will need approximately 3 metres of 2.5 mm of nylon cord the bump head unit either side on the grooves and pull to remove the top of the head. Remove the spool, spring and washer from the spindle.

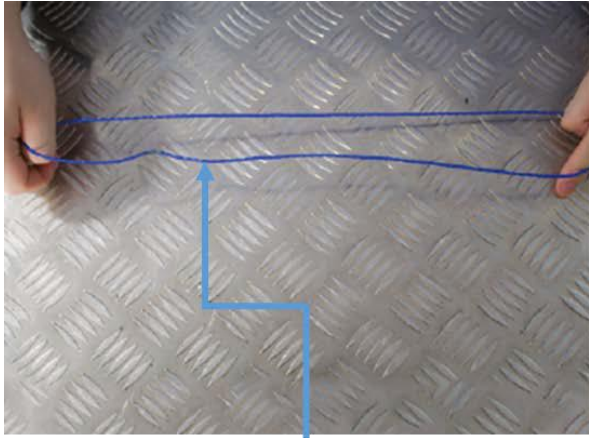

Take cutting line and fold in half

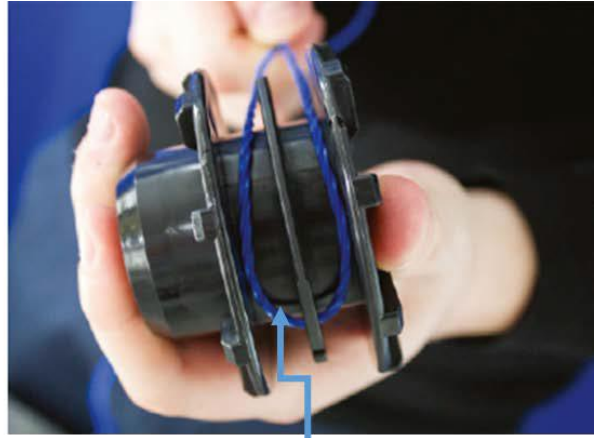

Place the looped end over the spool

Wrap the nylon cord around the spool in an anti-clockwise direction until you have approximately - 150 mm (6"). Then insert spool back into the spindle. Feed the line through the two notches in the spindle and reinsert the washer and spring into the spool. Once complete re-attach the spindle to the cutting head.

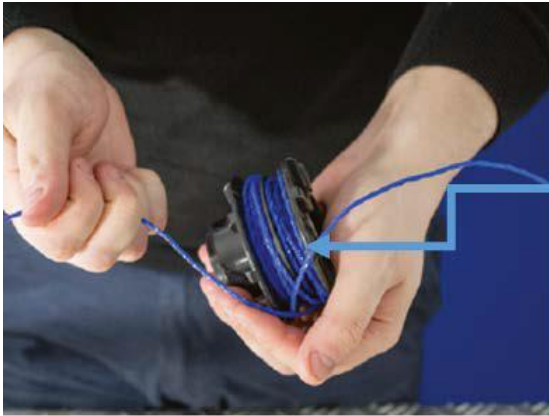

Wrap the nylon cord around the spool in an anti-clockwise direction until you have approximately - 150 mm (6").

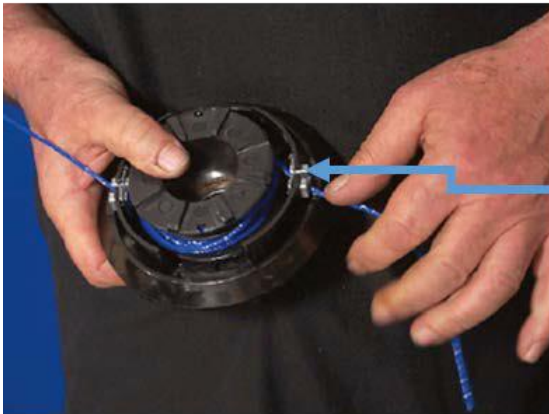

Then insert spool back into the spindle. Feed the line through the two notches in the spindle.



Reinsert the washer and spring into the spool. Once complete re-attach the spindle to the cutting head.

3. STARTING PROCEDURE

Fill with fuel/oil mixture, make sure the fuel cap is secure – see section 2.11. - Set the power switch on the handle to the ON position.

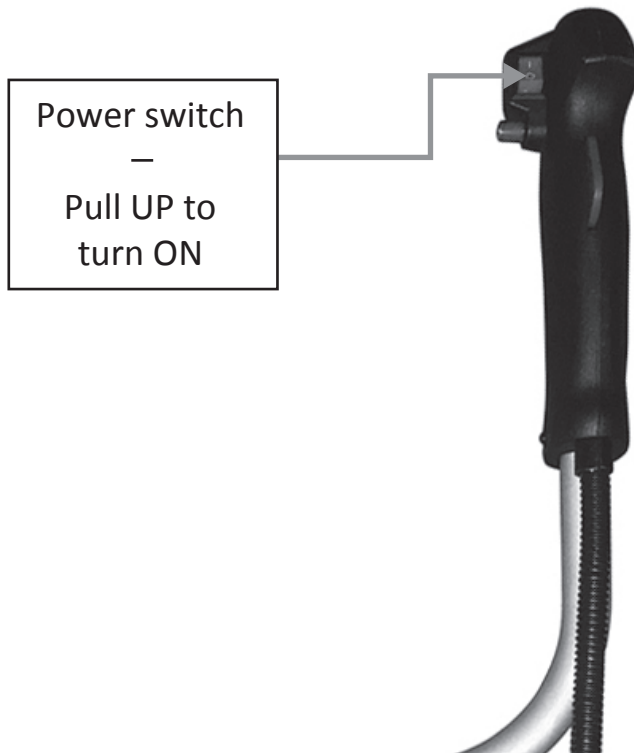

Pump the primer bulb about 8 to 10 times until fuel shows in the bulb.



Primer bulb

For COLD start move choke lever UP to start position. N.B. For a WARM/HOT start you will probably not need to do this.

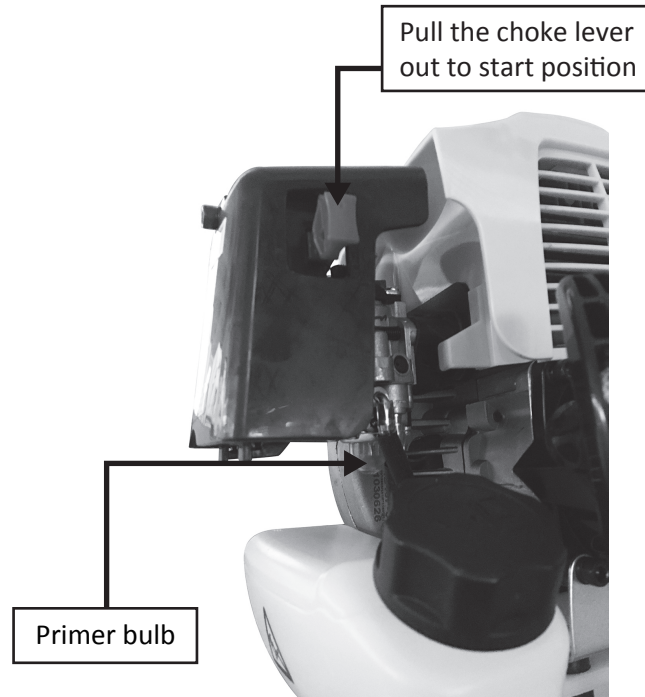

Place one hand on the machine, and using the other hand pull the recoil until you feel a resistance, then pull briskly. Repeat until machine starts. When the engine starts move the choke to the OFF position. DO NOT let go of the recoil handle instead allow the recoil cord to return gently. Once started you need to reduce the choke by slowly moving lever to RUN position if engine falters move choke between START/RUN positions and adjust until engine runs smoothly.

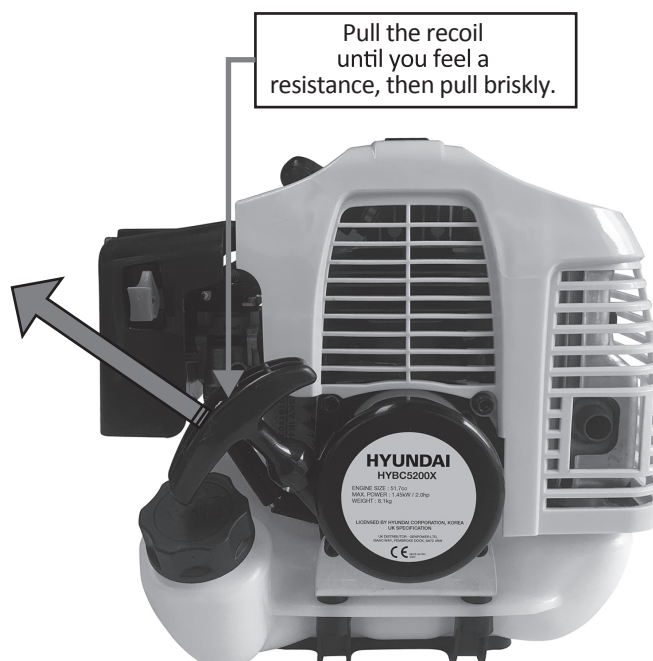

Before starting work allow the engine to warm up. Once the engine has warmed up (2/3 minutes) you can apply the throttle. Press both the throttle lock and throttle lever together. To adjust the amount of throttle partiality release the throttle lever only. The throttle trigger can be locked into place by pressing the trigger lock button. To release the trigger lock press and release the throttle trigger.



4. STOPPING PROCEDURE

- 4.1. Before stopping the machine allow the engine to cool down for a few minutes, by allowing it to run without throttle.
- 4.2. You MUST allow the cutting head to come to a full stop before carrying out any maintenance on the machine.

To STOP the machine release the throttle lever, allow the machine to cool down with no throttle then move the power switch to the OFF position.



5. USING THE MACHINE

WARNING

During use the engine and exhaust gets very HOT. You must keep all parts of the body and clothing clear. DO NOT leave a HOT machine near combustible materials.

5.1. Before starting work.

5.1.1. YOU MUST check the work area for obstacles such as stones, metal rods or other objects. If these cannot be removed, mark these positions, so you can avoid contact with the trimmer head and objects. Overhead power lines can be caught on the blade head if machine is swirled in the air.

5.2. Accessories.

5.2.1. Make sure that your product is only equipped with original accessories. Only use the machine with original parts which are specified by the manufacturer. The use of any other accessories may cause injury to the user and damage to the machine.

5.3. Wearing the shoulder harness.

CAUTION

When you use this machine always wear the provided harness.

Make sure that the machine is securely hooked onto the strap.

If you do not, you will not be able to control the machine safely.

This may result in injury to yourself or other people.

Never use a harness with any type of defect especially with a defective quick release mechanism.

a. Put the harness on.



b. Connect quick release buckle.

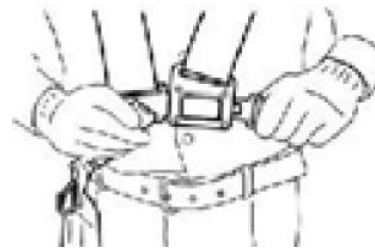

c. 1 = Protector Shield and machine hook. Attach machine to machine hook.

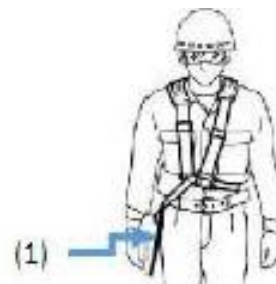

d. Adjust the harness to suit the user.



e. 1 = Quick release Harness buckle.

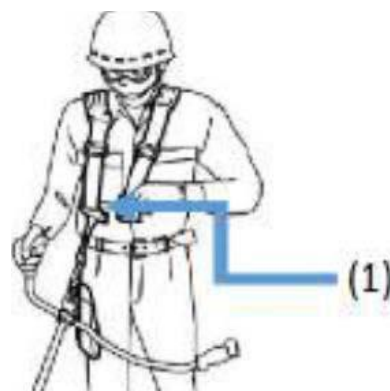

f. The shoulder strap is fitted with a quick release device (see image) fitted. You can remove the shoulder strap quickly by pulling the quick release device.

5.4. Trimming techniques.

CAUTION

If you are not familiar with the trimming, practice with the machine with the machine stopped.

5.4.1. Always trim or cut with the engine running at high speed.

5.4.2. Do not run the machine slowly except for when warming up before use or cooling down after use.

5.4.3. Swing the nylon cutting head of the trimmer horizontally from left to right.



5.4.4. Keep cutting deck parallel with the ground. Do not tilt the nylon cutting or blade head during operation.

5.4.5. For correct cutting height trim a test area in advance.

5.4.6. Keep nylon cutting or blade head at the same level for an even depth of cut.

5.4.7. Nylon trimming head is only to be used for trimming grass.

5.4.8. Metal blade head is only to be used for cutting brush.

5.4.9. To prevent overheating NEVER over cut, instead cut off smaller lengths of grass or brush. You MUST also remove any tangled materials – You MUST stop the machine and remove the HT lead before carrying out this task.

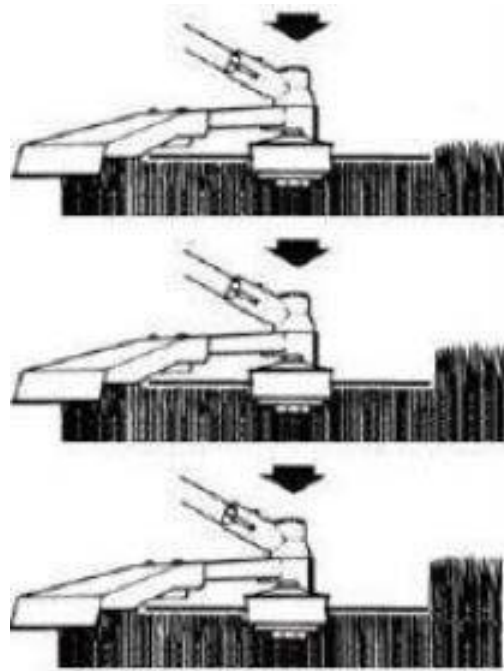

5.4.10. When trimming around trees trim slowly making sure that the nylon cord does not come into contact with the trunk. Walk around the tree from left to right and approach grass with the tip of the cutting nylon cord.

5.4.11. To release more nylon cutting cord run the machine at full throttle and tap the nylon cutting head on the grass. The nylon cord is then released. Any excess cord is cut off by the trimmer blade mounted on the guard. When trimming near brick or stone walls the nylon cord will wear out quicker.

6. MAINTENANCE

WARNING

Always stop the engine and unplug the spark plug before doing any repairs or maintenance. Never touch the rotating nylon cord or blade.

Check and maintain fuel level regularly, and maintain the fuel/oil mix to the correct ratio. Frequently check the brush cutter and make sure that all grass deposits are removed from the trimmer head and/or blade

Check the blade, in order to obtain a good cut, the blade should always be sharp and well balanced. At regular intervals, check the tightness of all nuts, bolts and screws.

If the blade hits an obstacle check for damage and if the machine vibrates badly stop the lawnmower and take it to a service dealer.

CAUTION

Always refuel in a well-ventilated area with the engine off.

Whilst carrying out maintenance you must wear appropriate Personal Protective Equipment (PPE). Suggested PPE Sturdy footwear, work gloves (especially when working near blade), long trousers and hearing protection.

Component		Maintenance cycle				
		Each use	Every 3 mths or 15 hours	Every 6 mths or 50 hours	Every 12 mths or 100 hours	Every 24 mths or 300 hours
Air filter	Check	o				
	Clean		o a			
Sparkplug	Check/Adjust				o	
	Change					o
Sparkplug electrode	Clean				o	
Cooling fins	Check/Clean			o		
Connections – nuts bolts screws etc.	Check and tighten as required	o				
Coupling	Examine			o b		
Idle	Check/Adjust				o b	
Valve clearance	Check/Adjust				o b	
Spark arrester	Check/Clean	Every 300hours				
Fuel tank	Examine				o	
Fuel pipes	Examine					
Bevel gear	Fill	After 25 hours of use (For location of bevel gear grease nipple Section 9 Part Location.				

a = Increase maintenance intervals if operating in dusty environments. b = All maintenance operations - except those listed in the operating instructions, must be performed by qualified service personnel

6.1. Air filter.

CAUTION

Never let the engine run without the air filter. A dirty air filter element affects the engine performance, increases fuel consumption and makes it difficult to start. If you notice a loss of engine power.

6.1.1. Remove the air filter cover by undoing the Allen bolt using the supplied Allen key.

6.1.2. Carefully remove the outer cover, then remove the inner cover.

6.1.3. Once the inner cover has been removed you can remove the foam air filter element. If it is damaged replace it. Otherwise wash the element in clean soapy water, rinse in fresh water and allow to fully air dry before replacing filter element.

N.B. To reinstate the filter assembly reverse the above process.

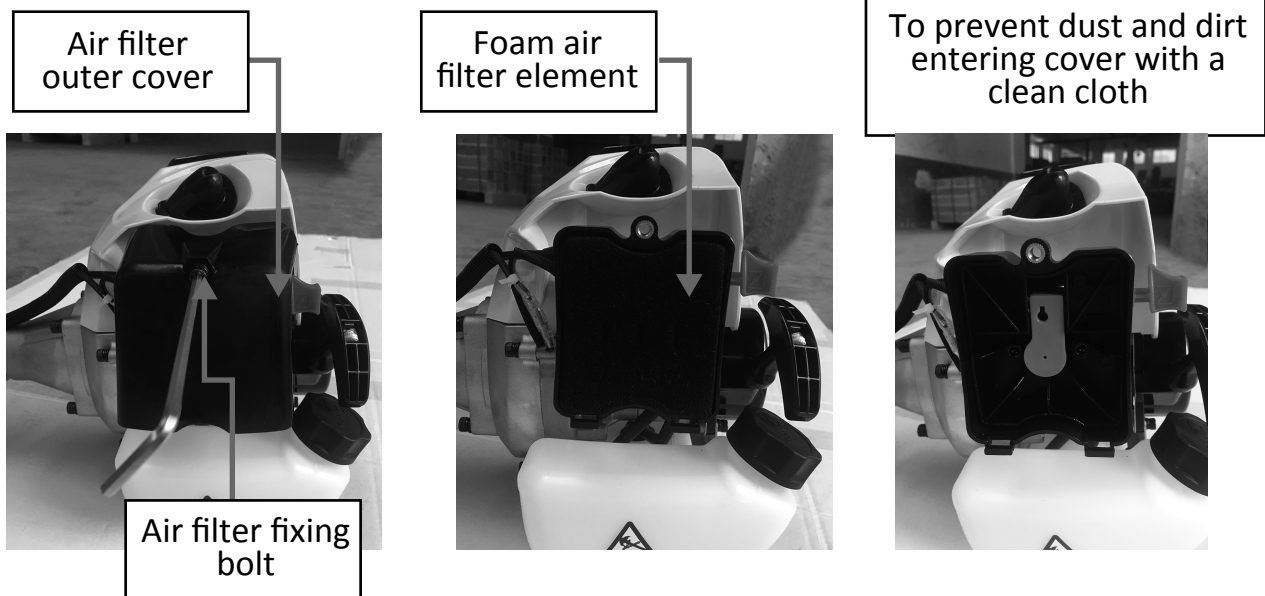

6.2. Spark plug.

WARNING

The spark plug MUST be fully tightened otherwise the engine will overheat causing damage. Always complete the following steps after the engine has been turned off and allowed to cool down.

6.2.1. To make sure the engine runs correctly a spark plug gap of 0.6 -0.7 mm must be maintained and the spark plug must be free of carbon deposits.

6.2.1. To remove the spark undo the cover then pull back the protective cover. Pull off the HT lead and then undo the spark plug using the supplied box spanner in an anti-clockwise direction.

6.2.3. Once the plug has been removed check it for visual damage, electrode wear and carbon deposits. Replace a damaged or badly worn spark plug. Clean off any carbon deposits by using a soft brass brush.

6.2.4. Check the gap with a feeler gauge and adjust electrode at the correct gap of 0.6 -0.7 mm.

6.2.5. Check the washer (replace as required) of the spark plug. Refit the spark plug by hand to make sure it does not cross thread, tighten the spark plug to a torque of 12/15Nm.

6.2.6. To refit spark plug reverse the above process.

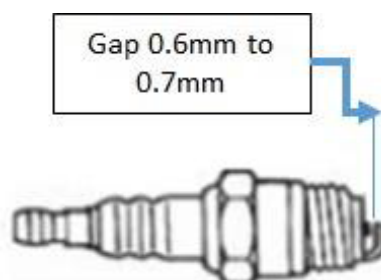
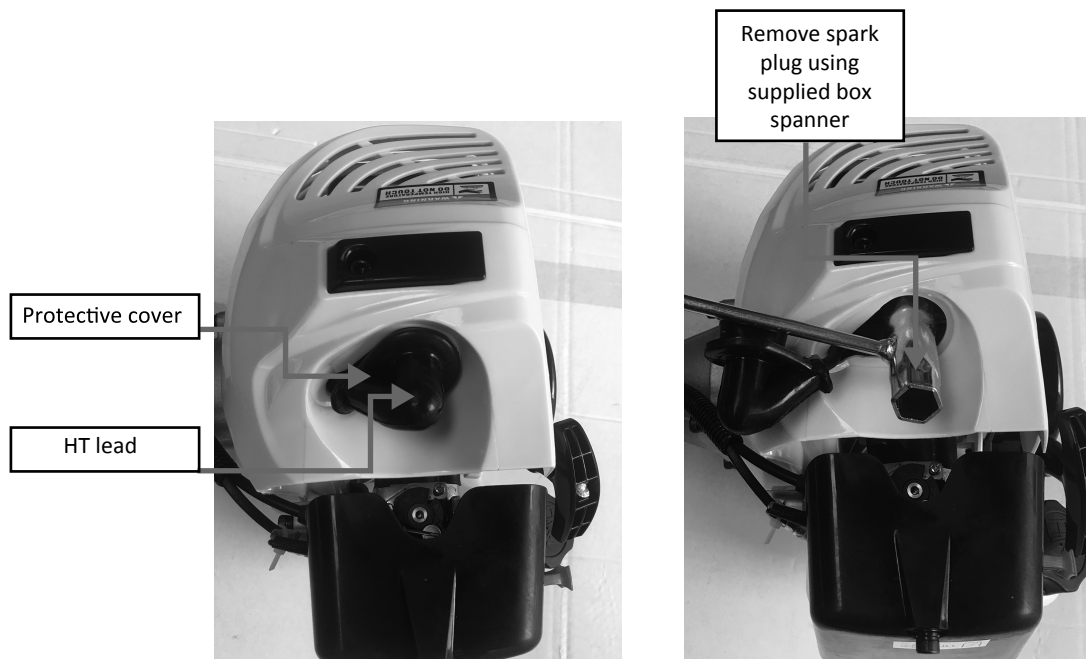

6.3. Trimmer blade sharpening

WARNING

When sharpening the blade you MUST wear safety gloves.

6.3.1. Remove the cutting blade from the shield. Remove the blade by undoing the 2 self-tapping screws (put in a safe place). Place the blade firmly into a vice.

6.3.2. Sharpen blade using a suitable flat file. You MUST maintain the blades original cutting angle.

6.3.3. Reverse process to refit blade.

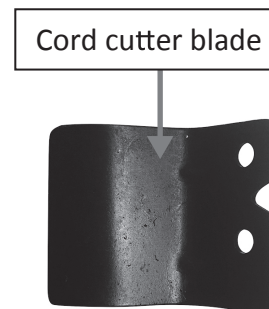
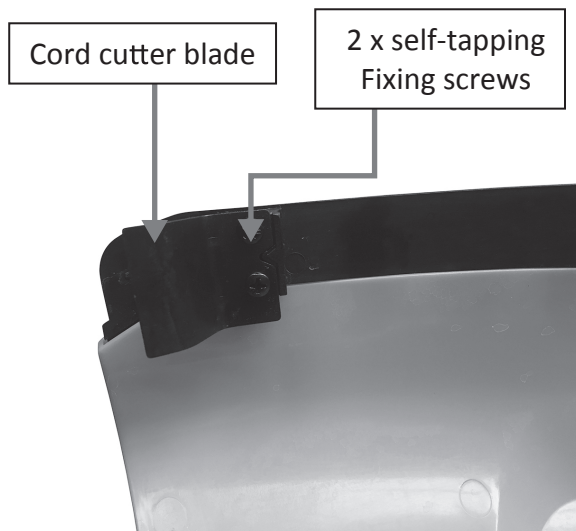

6.4. Storage.

WARNING

If you do not follow these steps, deposit may arise in the carburetor. This will cause starting difficulties and may cause permanent damage.

6.4.1. Perform all the general maintenance that the maintenance section of your 'User Manual' is recommended.

6.4.2. Clean the outside of the machine, drive axle, shield and nylon cutting head.

6.4.3. Remove all fuel from the fuel tank.

6.4.4. After all the fuel has been removed from the fuel tank. Start the engine. Allow the engine to run in idle until engine stops alone. This allows the fuel to be removed from the carburetor.

6.4.5. Allow the engine to cool down for

about five minutes.

6.4.6. Remove the spark plug and pour 1 teaspoon of clean oil into the combustion chamber. Slowly pull the starter rope several times to coat internal components. Replace the spark plug.

6.4.7. Store the machine in a cool, dry place away from any source of ignition such as an oil burner, water heater etc.

6.5. Transporting the machine.

6.5.1. When transporting the machine make sure that no fuel is allowed to leak out.

6.5.2. DO NOT allow the trimmer/brush cutter come into contact with persons, animals and property.

7. TROUBLESHOOTING

CAUTION

7.1. If troubleshooting does not solve the problem, contact your dealer or the manufacturer directly. Use only original parts approved by the manufacturer, otherwise a hazard risk arises.

NO SPARK

Possible causes;

1. Carbon deposit between electrodes of the spark plug.
2. Ignition coil defective flywheel magneto too weak.

Possible corrective actions;

1. Clean the spark plug. Adjust the gap to 0.6 ~ 0.7mm, Replace the spark plug.
2. Replace the Ignition coil or the flywheel.

WEAK SPARK

Possible causes;

1. Too much fuel in the combustion chamber, poor fuel or water in tank.
2. Blocked fuel line

Possible corrective actions;

1. Remove spark plug and dry, replace fuel.
2. Clean the carburetor and clean the lines.

NORMAL FUEL SUPPLY BUT WEAK COMPRESSION

Possible causes;

1. Worn piston rings, spark plug not tightened, the cylinder head is not tightly wrong valve clearance or ignition.

Possible corrective actions;

1. Replace or adjust.

NORMAL FUEL SUPPLY AND POOR SPARK

Possible causes;

1. Poor contact between spark plug cap and spark plug.

Possible corrective actions;

1. Check or exchange.

MOTOR DOES NOT COME UPTO SPEED

Possible causes;

1. Choke is in "cold start" position, exhaust system does not clog air supply, worn Movable elements, spark weak, valve clearance to big, sooty cylinder head.

Possible corrective actions;

1. Open choke, exhaust system ignition coil exchange check or replace flywheel Adjust spark plug.

POWER RUNS OUT

Possible causes;

1. Congested fuel lines to the carburetor. Spark plug gap incorrect.

Possible corrective actions;

1. Unblock/Replace lines and carburetor. Reset spark plug gap.

NOISY ENGINE

Possible causes;

1. Incorrect choke lever position, or damage to crankshaft.

Possible corrective actions;

1. Check and correct choke lever position. Check and/or replace crankshaft.

LEAKING CARBURETTOR

Possible causes;

1. Failure of the non-return valve on the fuel tank lid. Worn carburetor gasket.

Possible corrective actions;

1. Replace the fuel cap. Replace the carburetor seal.

8. SPECIFICATION

Model:	HYBC5200X
Type of engine:	IC52-2J
Sort of engine:	2 stroke air-cooled
Engine volume:	51.7 cm ³
Maximum engine power:	1.45 kW
Number of revolutions	
· string head:	6525 rpm
· blade head:	6900 rpm
Length of the shaft housing:	1640 mm
Type of handle:	Two-handed
Fuel:	A mixture of fuel and oil 40:1 (2.5%)
Fuel tank capacity:	1.2 L
Head:	Thread and blade
Power Unit Net weight:	7.6 kg
Sound pressure level $L_{p(A)}$:	106 dB(A)
Sound power level $L_{w(A)}$:	110 dB(A)
Vibrations:	6,83 / 6,37 m/s ² (string) 8,71 / 6,12 m/s ² (blade)

NOTE: These manual instructions are for the above-mentioned machines. In the case of deviations between the individual models of the engine, the specificity of each engine is crucial in terms of technology and application.

We reserve the right to make changes without prior notice

9. PART LOCATIONS



- 1 - Fuel tank
- 2 - Recoil Start
- 3 - Air filter
- 4 - Start button
- 5 - Harness

- 6 - Handle
- 7 - Shaft
- 8 - Guard
- 9 - Blade
- 10 - Throttle

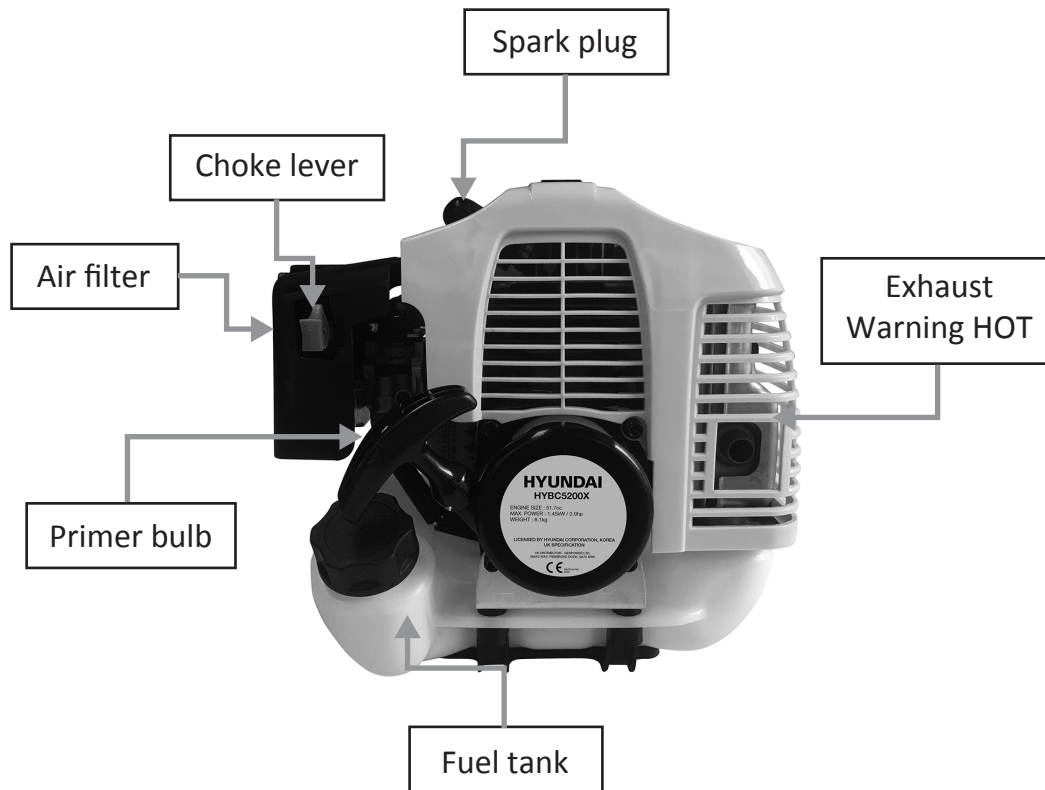

10. EC DECLARATION OF CONFORMITY

We hereby declare that the machine detailed in this declaration complies to all the relevant provisions of the following EC directives.

- 2006/42/EC The Machinery Directive
- 2014/30/EU Annex II Electromagnetic Compatibility Directive
- 2016/1628/EC The Emission of Gaseous and Particulate Pollutants from internal Combustion engines
- 2000/14/EC Noise Emissions in the Environment by Equipment for use Outdoors

And is in conformity with the applicable requirements of the following documents:

- EN ISO 11806-1:2011
- EN ISO 10517:2019

Declaration for 2000/14/EC Noise Emissions in the Environment by Equipment for use Outdoors.

Notified Body for EC Directive 2000/14/EC TÜV Rheinland (Shanghai) Co., Ltd.

Model	Type	Engine Size	Measured Sound Power	Guaranteed Sound Power	Engine Output
HYMT5200X HYBC5200X HYPS5200X HYPT5200X	Multi-tool Brushcutter Pole Saw Pole Trimmer	51.7cc	99dB(A)	112dB(A)	1.45kW

Product Details

Brand: Hyundai

Model: HYMT5200X, HYBC5200X, HYPS5200X, HYPT5200X

Description: Petrol brushcutter, multi-tool, pole saw and pole hedgetrimmer.

Name and address of technical documentation holder and EU distributor:

Genpower Ltd, Isaac Way, Pembroke Dock, Pembrokeshire, SA72 4RW, UK.

Signed by:  Roland Llewelin, Managing Director

Date: 16/12/2019

11. RECYCLING & PRODUCT DISPOSAL

11.1. We do not offer a takeback scheme for the recovery of Waste Electrical Electronic Equipment (WEEE) & Batteries instead the responsibility to dispose of WEEE and or Batteries is passed onto you by us. So when it becomes necessary to dispose of your machine you must take it to your local Civic Amenity Site. For further information please contact your Local Authority for disposal advice.

11.2. You MUST make sure that all unused oil and fuel is disposed of correctly either beforehand or at your local Civic Amenity Site. Under NO circumstance must any oil and fuel be put down any drains.

11.3. Waste Electrical Electronic Equipment (WEEE) recycling.



11.3.1. Certain products contain WEEE waste which should not be disposed of in your domestic waste.

11.3.2. You MUST recycle WEEE in accordance with your local authority or recycling centre.

11.4. Battery recycling, certain products contain batteries which should not be disposed of in your domestic waste.



11.4.1. You MUST recycle batteries in accordance with your local authority or recycling centre.

11.5. Unwanted packaging materials should be sorted and taken to a recycling centre so it can be disposed of in a manner which is compatible with the environment.

11.6. The following symbol means that you should 'Reduce – Reuse – Recycle'.



11.7. We are a Member of the VALPAK National Compliance scheme and our registration number is RM08660.

11.8. For further information about disposal please contact your Local Authority.

11.9. You can also get more advice and guidance about recycling at the following website <http://www.recycle-more.co.uk>

11.10. Should you pass this product onto another user either sold or loaned you MUST pass on this user manual. This will make sure that all other users can use and maintain the machine safely.

12. CONTACT DETAILS

POSTAL ADDRESS

Genpower Ltd, Isaac Way, London Road, Pembroke Dock, Pembrokeshire, SA72 4RW. UK.

TELEPHONE

+44 (0) 1646 687880

FAX

+44 (0) 1646 686198

TECHNICAL E-MAIL

aftersales@hyundaipowerproducts.co.uk

WEBSITE

www.hyundaipowerproducts.co.uk

13. MANUAL UPDATES

13.1. Our manuals are constantly being reviewed and updated. Should you find an error, omission or something you find unclear please contact your dealer for assistance. E&OE.

13.2. Our latest manuals are also placed online.

13.3. We reserve the right to make any modifications without prior notice whenever necessary.

14. WARRANTY

14.1. Proof of purchase will be required before you make a warranty claim.

Full warranty terms and conditions can be found on the HYUNDAI POWER PRODUCTS website: www.hyundaipowerproducts.co.uk

15. SPARE PARTS

15.1. Only use original parts: The use of non-original and/or incorrectly fitted parts will jeopardize the safety of the machine, may cause accidents or personal injuries for which the manufacturer is under no circumstance liable or responsible.

Part	Part Number
Recoil Start	HYBC5200XRECOIL
Guard	HYBC5200XGUARD
Spark Plug	HYBC5200XSPARKPLUG

HYUNDAI

POWER PRODUCTS

Importer:
GENPOWER LTD
Isaac Way, London Road,
Pembroke Dock, UNITED KINGDOM, SA72 4RW
T: +44 (0) 1646 687 880 F: +44 (0) 1646 686 198
E: info@hyundaipowerequipment.co.uk
www.hyundaipowerproducts.co.uk

Imported/Distributed by Genpower Ltd for The United Kingdom & Ireland

Licensed by Hyundai Corporation, Korea