

HYUNDAI
POWER PRODUCTS

PETROL BRUSHCUTTER

HYBC5080AV

User Manual

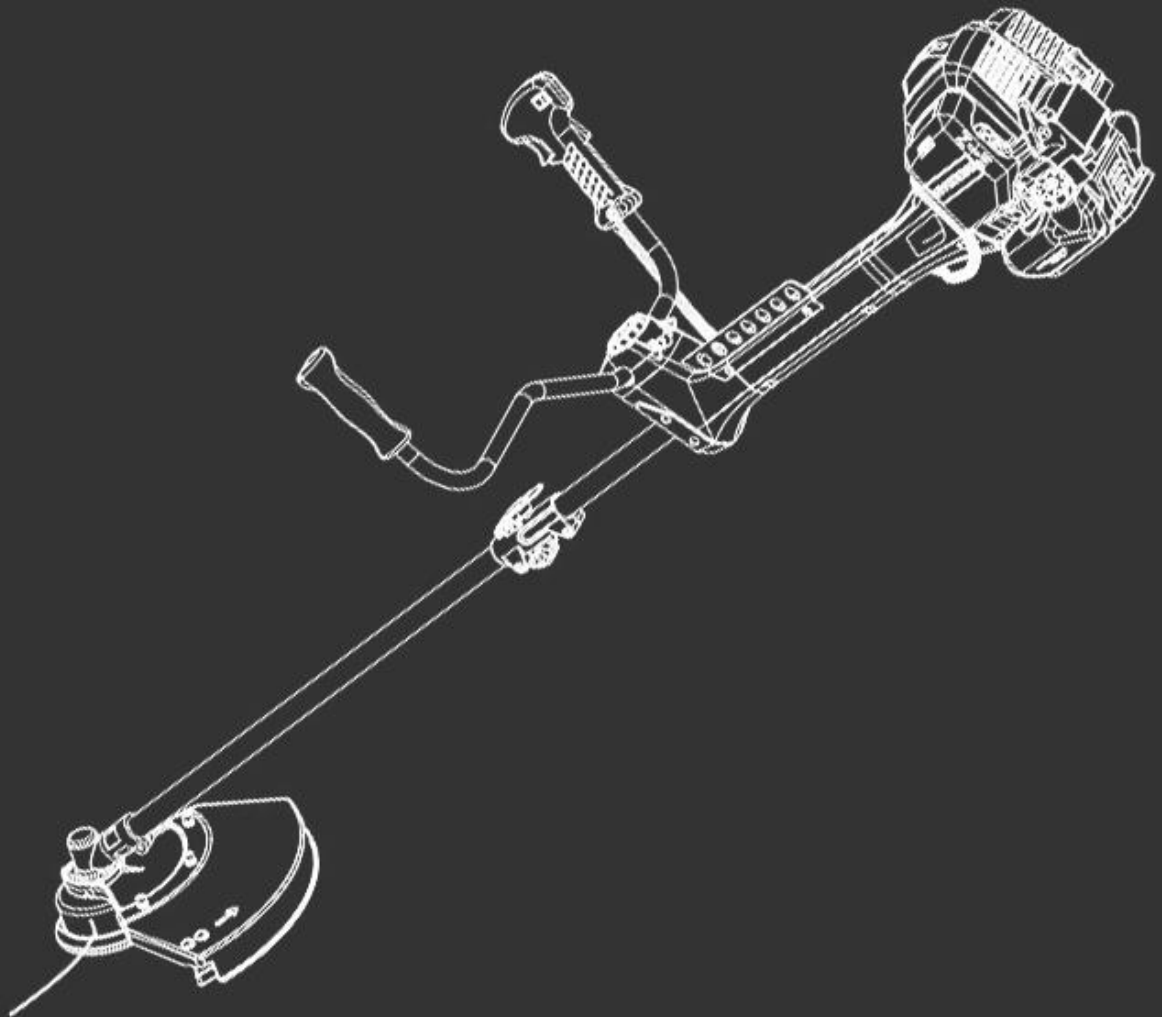

CONTENTS

1.	SAFETY	4 - 7
2.	QUICK START	8 - 18
3.	STARTING PROCEDURE	19 - 21
4.	STOPPING PROCEDURE	21
5.	USING THE MACHINE	22 - 23
6.	MAINTENANCE	24 - 27
7.	TROUBLESHOOTING	28
8.	SPECIFICATION	29
9.	PART LOCATIONS	30
10.	DECLARATIONS OF CONFORMITY	31
11.	RECYCLING & PRODUCT DISPOSAL	32
12.	CONTACT DETAILS	32
13.	MANUAL UPDATES	32
14.	WARRANTY	33

1. SAFETY

1.1. General safety notes.

1.1.1. The operator of the machine is responsible for, and has a duty of care in making sure that the machine is operated safely and in accordance with the instructions in this user manual. Keep the manual safe and pass it on if the machine is loaned or sold to another user.

1.1.2. Please note the following safety points.

1.1.2.1. The machine should never be left in a condition which would allow an untrained or unauthorised person/s to operate this machine.

1.1.2.1.1. All due care and diligence should be taken by the operator for the safety of, and with regard to, those around whilst using the machine.

1.1.2.1.2. Some or all of the following - warning signs, symbols and/or PPE pictograms may appear throughout this manual. You MUST adhere to their warning/s. Failure to do so may result in personal injury to yourself or those around you.

DANGER

Indicates a hazard, which, if not avoided, could result in serious injury or death.

WARNING

Indicates a hazard, which, if not avoided, could result in serious injury.

CAUTION

Indicates a hazard which, if not avoided, might result in minor or moderate injury.

NOTE

Indicates a situation that could easily result in equipment damage.



READ and keep the manual safe and pass it on if the machine is loaned or sold to another user. You MUST fully read instructions to make sure you use and operate machine safely.

Appropriate Personal Protective Equipment (PPE), MUST be worn at all times when machine is in use or being repaired.



1.2. Carbon monoxide (where applicable).

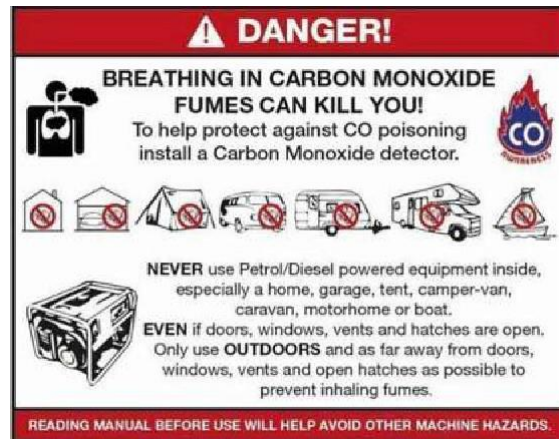

1.2.1. Carbon monoxide is a colourless and odourless gas. Inhaling this gas can cause death as well as serious long term health problems such as brain damage.

1.2.2. The symptoms of carbon monoxide poisoning can include but are not limited to the following; Headaches, dizziness, nausea, breathlessness, collapsing or loss of consciousness.

1.2.2.1. Carbon monoxide poisoning symptoms are similar to flu, food poisoning, viral infections and simply tiredness. It is quite common for people to mistake this very dangerous poisoning for something else.

1.2.2.2. To avoid carbon monoxide poisoning DO NOT use Petrol/Diesel- powered equipment inside any of the following; Home, garage, tent, camper van, mobile home, caravan or boat.

This list is not exhaustive and if you are in any doubt contact your dealer.

1.2.3. If you think you have or someone around you has been affected by carbon monoxide poisoning;

1.2.3.1. Get them fresh air immediately, by leaving the affected area or by opening doors and windows. If safe and practical to do so make sure that the machine is turned off. DO NOT enter a room you suspect of having carbon monoxide present – instead call the emergency services.

1.2.3.2. Contact a doctor immediately or go to hospital - let them know that you suspect carbon monoxide poisoning.

1.2.4 DO NOT use in an enclosed area or a moving vehicle.

1.3. General fuel safety (where applicable).



ALL FUELS ARE FLAMMABLE

1.3.1. Fire hazard - keep fuel away from all sources of ignition for example heaters, lamps, sparks from grinding or welding.



Fire Hazard

1.3.2. DO NOT carry out hot work on tanks that have contained fuel it is extremely dangerous.

1.3.3. ALWAYS keep work area clean and tidy.

1.3.4. ALWAYS clean up all spills promptly using correct methods i.e. absorbent granules and a lidded bin.

1.3.5. ALWAYS dispose of waste fuels correctly.

1.4. Fuelling/De-fuelling (where applicable).



ALL FUELS ARE FLAMMABLE

1.4.1. ALWAYS fuel and defuel in a well-ventilated area outside of buildings.

1.4.2. ALWAYS wear correct, suitable and fit for purpose Personal Protective Equipment (PPE), suggested items are but not limited to safety gloves and overalls.



1.4.3. When fuelling/de-fuelling ALWAYS avoid inhaling fumes

1.4.4. When de-fuelling ALWAYS use a propriety fuel retriever.

1.4.5. ALWAYS carry fuel in the correct and clearly marked container.



Fire Hazard

1.5. Electrical safety (where applicable).



Risk of electric shock

1.5.1. Electricity can kill - NEVER work on LIVE/ENERGISED equipment.

1.5.2. Prior to carrying out any maintenance work you MUST Identify electrical isolation methods and isolate all electrical supplies,

1.5.3. Prior to use and with all electrical supplies isolated You MUST check all electrical cables, plugs and connections for the following;

1.5.3.1. Are intact and have no signs of damage, to include but not limited to bare wires, chaffing, cuts and loose wiring.

1.5.3.2. If there are any signs of damage, the damaged item MUST be taken out of service until the damage has been repaired by an electrically competent person.

1.5.3.3. All trailing cables should be routed so as not to cause any kind of trip hazard.

1.5.3.4. NEVER work on or near electricity with wet hands, wet clothing, and wet gloves.

1.6. Batteries (where present).



Corrosive

1.6.1. Batteries present a risk if they become damaged by the possible leaking of electrolyte. This electrolyte is an acid and can cause serious burn injuries. Care should be taken

when working on or near them. NOTE the electrolyte may be in liquid or gel form.

1.6.2. Should you come into contact with electrolyte you should;

1.6.2.1. Remove all clothing contaminated with electrolyte. If you cannot remove then saturate in water.

1.6.2.2. Get medical assistance as soon as possible. You must advise the medical staff of the type acid.

1.6.2.2.1. Lead/acid battery = dilute sulphuric acid

1.6.2.2.2. Nickel/cadmium = potassium hydroxide alkali electrolyte.

1.6.2.3. Use fresh running water to wash off excess electrolyte, continue this until medical assistance arrives. Make sure that you do not wash the electrolyte to another part of the face or body.

1.6.2.4. If electrolyte comes into contact with Eyes the electrolyte needs to be immediately washed away with large amounts of water. Make sure that you do not wash the electrolyte to another part of the face or body.

1.6.3. Gasses from charging batteries are highly flammable and great care should be taken to charge in well ventilated areas.

1.6.4. There is an explosion risk if the battery terminals are short circuited, when connecting/dis-connecting ALWAYS exercise great care so that the terminals or battery leads are NOT allowed to touch and cause a spark. ALWAYS use suitable insulated tools.



1.7. Vibrations (where applicable).

1.7.1. Prolonged use of hand held (operated) machines will cause the user to feel the effects of/from vibrations. These vibrations can lead to white finger (Raynaud's phenomenon) or carpal tunnel syndrome. This condition

reduces the ability of the hand to feel and regulate temperature, causing numbness and heat sensations and may cause nerve damage and circulatory tissue death.

1.7.2. Not all factors that lead to white finger disease are known, but cold weather, smoking and other diseases that affect blood vessels and blood circulation as well as large and long-lasting impact of shocks are considered factors in the formation of white finger. Note the following to reduce the risk the white finger and carpal tunnel syndrome:

1.7.2.1. Wear gloves and keep your hands warm

1.7.2.2. Take regular breaks

1.7.3. All of the above precautions may help reduce the risk of white finger disease but not rule out carpal tunnel syndrome. Long-term and regular users are therefore recommended to observe the condition of your hands and fingers. Seek medical attention immediately if any of the above symptoms should occur.

1.8. Noise (where applicable).

1.8.1. The operating noise of the machine can damage your hearing. Wear hearing protection such as earplugs or ear defenders to protect your hearing. Long-term and regular users are advised to have hearing checked regularly. Be especially vigilant and cautious when wearing hearing protection because your ability to hear alarm warnings will be reduced.

1.8.2. Noise emissions for this equipment is unavoidable. Carry out noisy work at approved times and for certain periods. Limit the working time to a minimum. For your personal protection and protection of people working nearby it is also advisable for them to wear hearing protection.

1.8.3. See CERTIFICATE of CONFORMITY section for Outdoor Noise declaration of conformity.



1.9. Additional safety labels.

Keep all children, bystanders and helpers 15 meters from the machine.



Warning against flying objects wear helmet, goggles and ear protection.



Warning: Danger from hot components, especially exhaust - Keep clear of combustible materials.



1.10. Additional safety instructions.

1.10.1. Spectators should be told how to correctly attract the operator's attention, otherwise it could create an unsafe situation.

1.10.2. Never touch either the nylon cutting head or the metal cutting blade whilst the machine is in use – You MUST allow the machine to come to a stop and to remove the HT lead before carrying out any maintenance.

1.10.3. During and after use the engine and exhaust will be very HOT you must keep all your all parts of your body and clothing including all combustible materials clear of the engine and exhaust.

1.10.4. DO NOT use the machine during or after rain, snow or sleet. The floor will become slippery. DO NOT use the machine on a slope or uneven ground or if there is the chance of slipping or losing the stability.

1.10.5. If you trip or fall whilst machine is in use you MUST immediately release the throttle, and turn off the ignition switch.

1.10.6. If you hit any obstacles you must stop the machine and remove the HT lead so that you can inspect the machine. IF the machine is

damaged in any way you MUST get it repaired before restarting work.

1.10.7. DO NOT use the machine with a blunt, cracked or damaged cutter blade.

1.10.8. When using the blade cutter there is a danger of kickback. Kickback is a reaction that can occur when the rotating cutting blade strikes an object which cannot be cut. This contact causes the cutting blade to stop for an instant and then suddenly repel from the object taken with accelerated force. This reaction can be violent enough that the operator momentary loses control of the machine. A kickback can occur without warning when the cutter encounters an unseen obstacle when the blade is running. This is more likely in areas where it is difficult to properly check the material/area to be cut. For easy and safe cutting, cut the weeds/brush from right to your left.

1.10.9. If any trimmed materials get tangled in the nylon cord or cutting blade you MUST stop the machine and remove the HT lead. Only then can you clear any blockages.

1.10.10. DANGER

NEVER use the machine with a saw blade attachment it is STRICTLY FORBIDDEN.

1.10.11. DO not use the brush cutter for trimming trees.

1.10.12. DO NOT wear rings and jewelry or loose, dangling clothing that could get caught in the machine. DO NOT wear footwear with unprotected toes and DO NOT work barefoot or without leg protection. In certain situations, you have to wear head protection.

2. QUICK START

You can also check out our online video at www.youtube.com/hyundaipowerequip

2.1. This guide is meant to serve as a quick reference for operating your Hyundai brush cutter. It is for convenience and the user should read the safety section first.

OUTDOOR USE ONLY.

This brush-cutter produces carbon monoxide - a poisonous, colourless & odourless gas that can cause death or serious injury. Petrol is highly flammable, always handle with extreme care and in a well ventilated area.

Always remove HT lead from spark plug when checking machine or changing parts.

2.2. This product includes:

Main unit, Operators handle, Trimmer head, Bump feed nylon trimmer head, 3 tooth steel blade, 5 tooth steel blade, Spare 2.5 mm nylon cord, Full harness, Gloves, Face shield, Ear defenders, Tool kit, Spare Bosch spark plug, 2-Stroke oil mixing bottle, User manual.

2.3. At this point, check that you have all of the included items listed above. If any are missing or damaged, call 01646 687 880 or email info@hyundaipowerproducts.co.uk.

2.4. Handle assembly.

Remove the nut and bolt from the trigger with the supplied Allen key. Place the trigger onto the handle. Align the holes on trigger with hole on the handle pole. Insert the nut and bolt and tighten.



Lift the White cover unscrew and remove the hand-wheel.

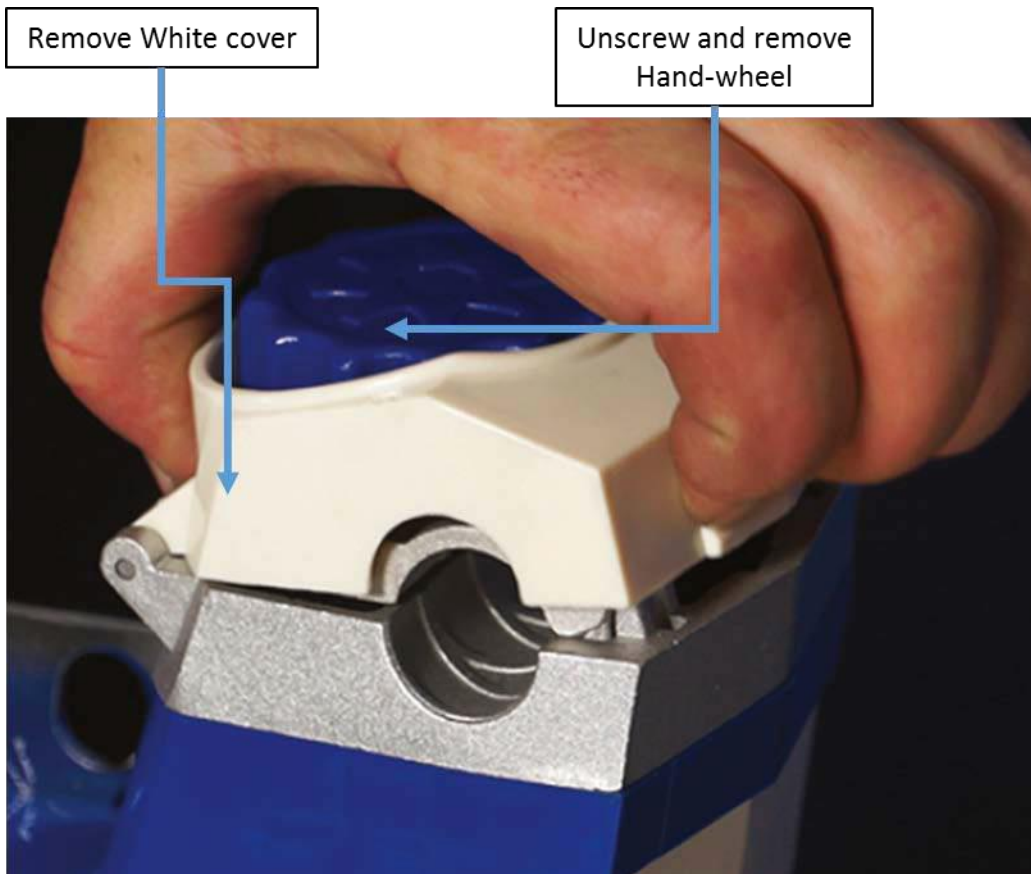

Push back the hinged cover, place the handle into the cradle, push hinge back over the handle-bar and lock into place using the hand-wheel. Push the White cover back into position.



2.5. Trimmer blade assembly.

Place the two bolts through the guard from the top.

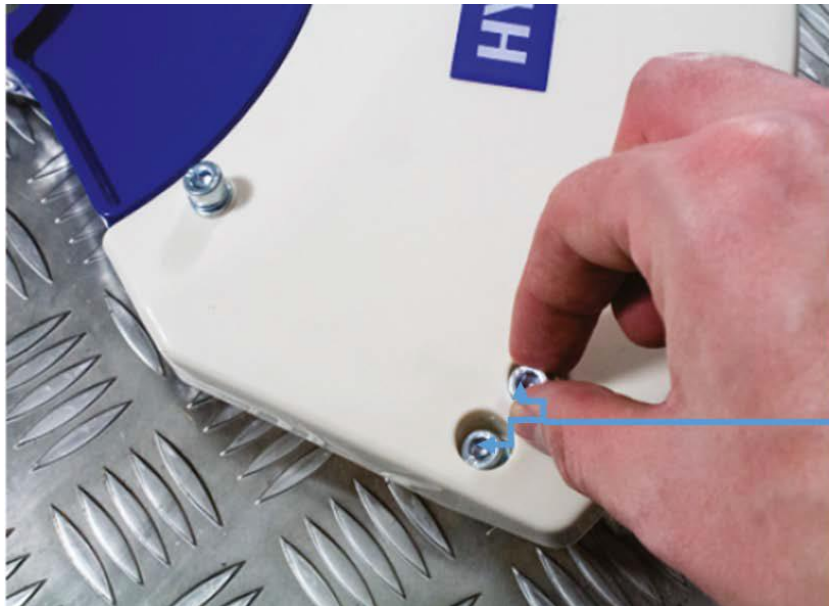

Push 2 x bolts through the guard from the top

On the underside of guard place the cutter over the bolts and secure in places using the 2 nuts. Tighten by using Allen key and spanner.

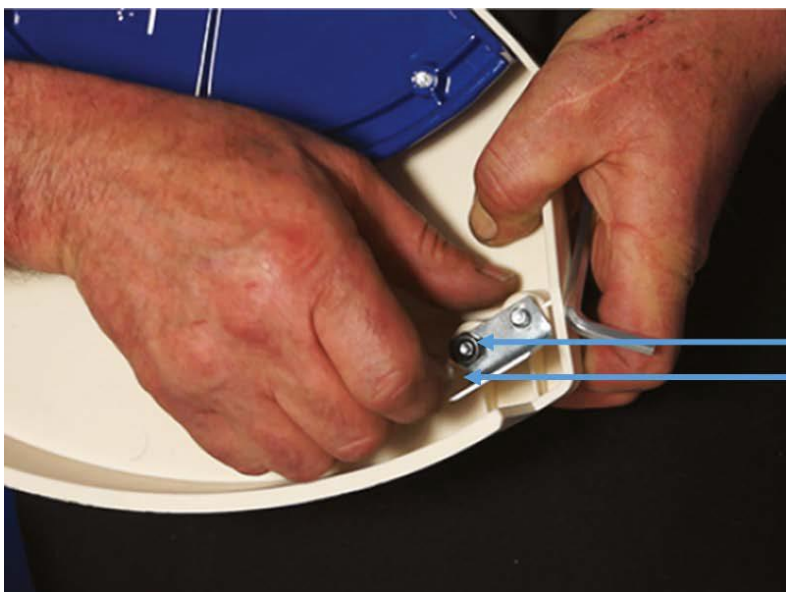

Place the cutter over the 2 x bolts
Then secure in place using the 2 nut.

Cutter blade

The cord cutter blade should have sharp cutting edge facing in direction shown in image below. If the blade is not mounted correctly it will not cut the cord at the correct length.

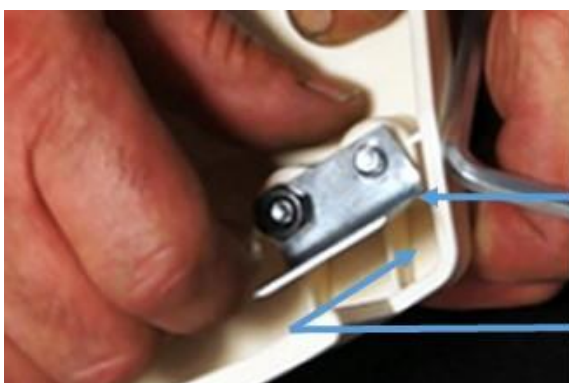

Sharp cutting edge

The cutter should have sharp cutting edge facing in this direction

2.6. Guard assembly.

Remove in this order - lock-nut, stainless steel cover, spacer and drive spacer.

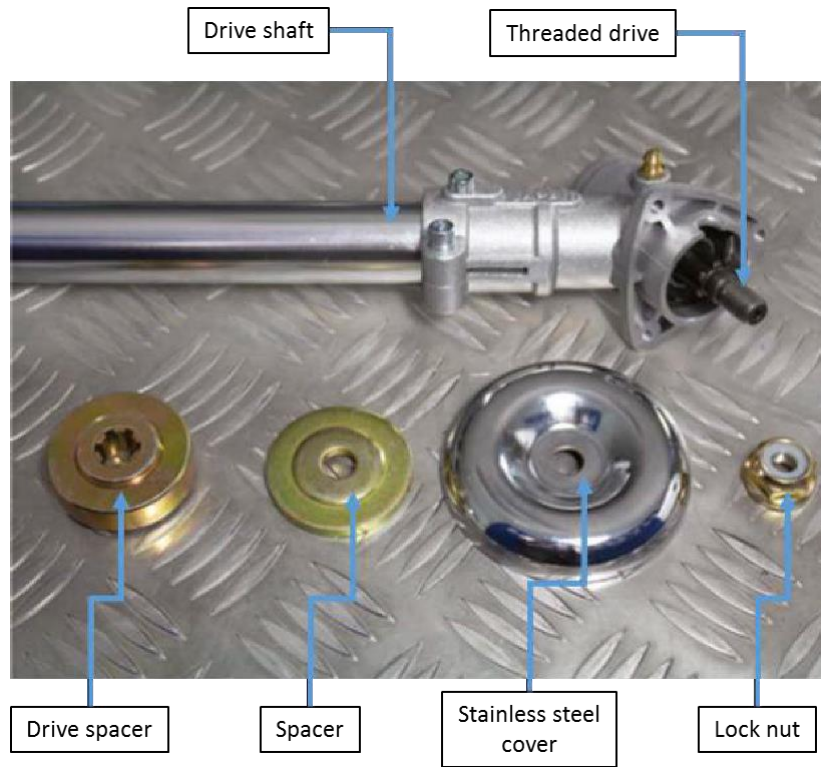

Place trimmer guard over threaded drive, align the three holes and secure in place using the 3 Allen bolts. Tighten in place using the Allen key.

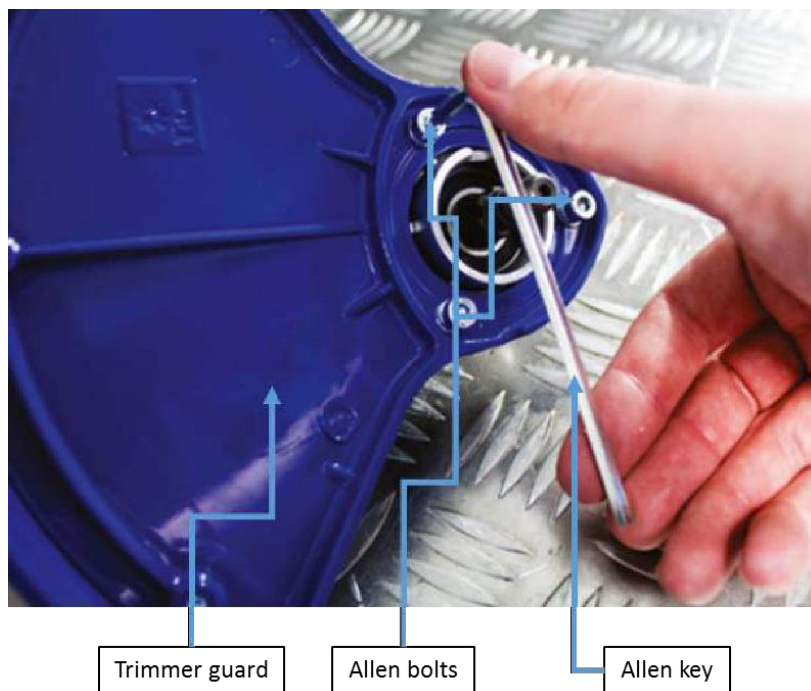

2.7. Grass trimmer assembly. (Bump trimmer head).

Place the drive spacer over the threaded drive. Then attach the trimmer head onto the threaded drive – tighten in an anti-clockwise direction.

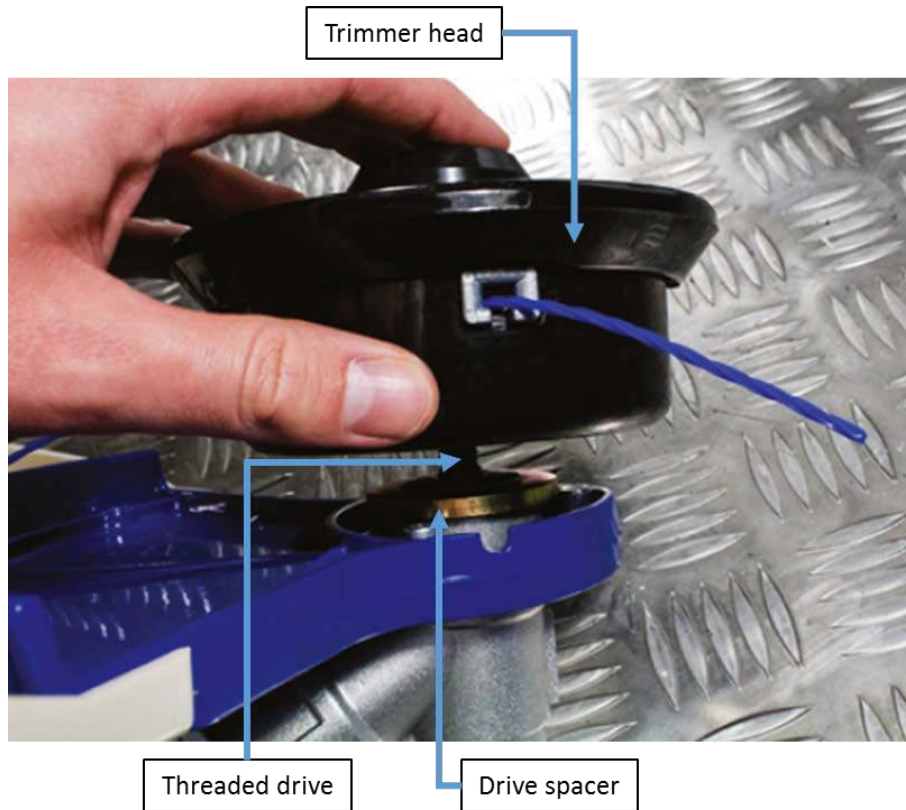

Align hole on drive spacer with groove on the guard, then using the Allen key lock the shaft in place – once shaft is locked you can tighten the trimmer head.

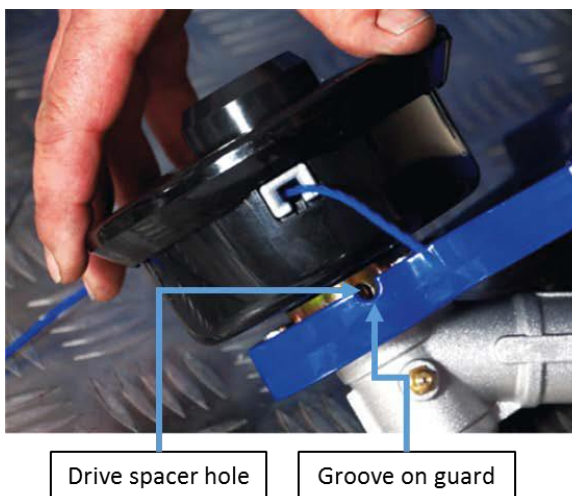

2.8. Cutting blade assembly. (Instruction to suit either 3 or 5 bladed cutter).

Place the drive spacer over the threaded drive – N.B. Raised area to be toward the thread

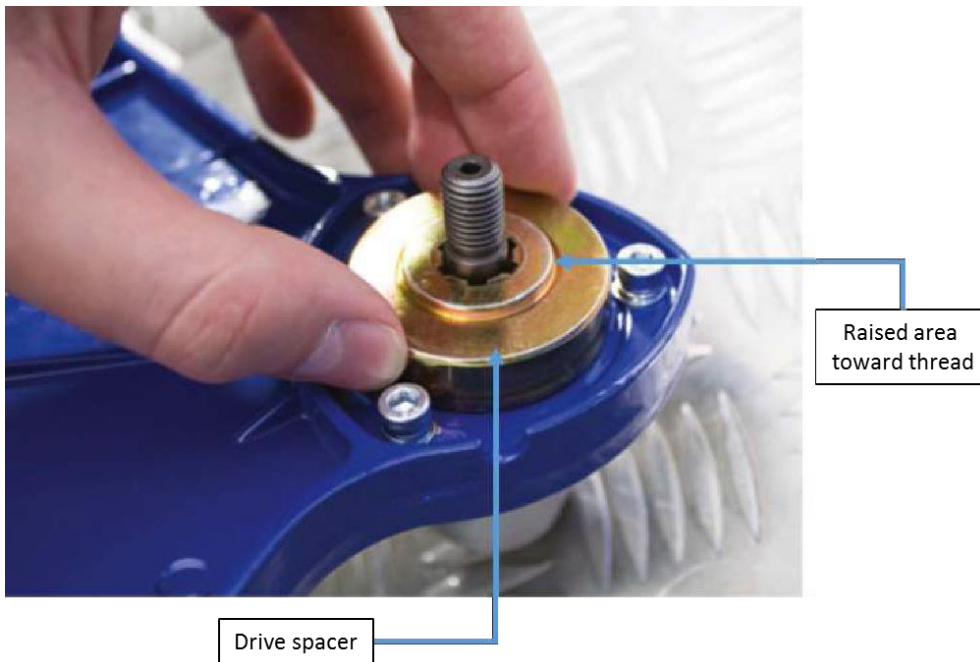

Place the over the threaded drive, then place spacer over threaded drive– N.B. Raised area to be toward the thread. N.B. There should be now writing showing.

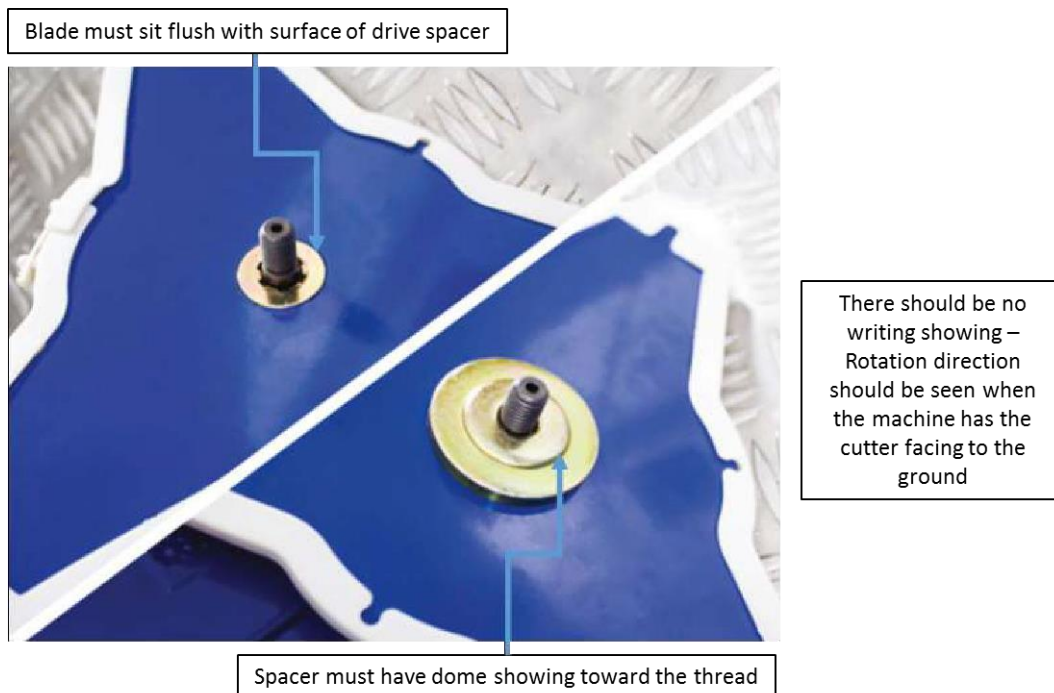

Once blade is in place, put the stainless steel cover over the spacer, put lock-nut onto threaded shaft and loosely tighten (anti-clockwise direction). Use the box spanner to over the lock-nut and tighten – use the Allen key to lock the shaft.

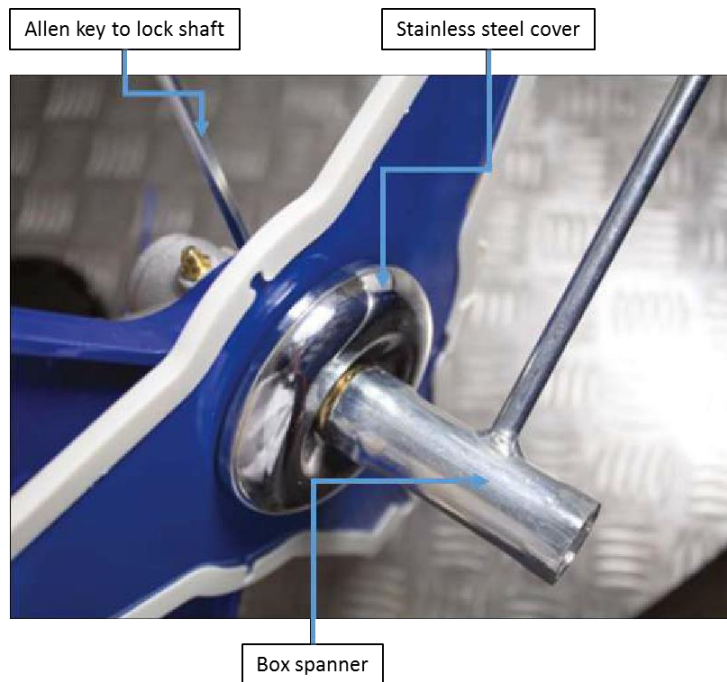

2.9. Drive shaft assembly.

Remove the rubber plug from the end of the shaft – Loosen the hand wheel then push the two shafts together and rotate until they click into place. Once locked into place tighten the hand wheel. To release shaft undo hand wheel then press release lever.

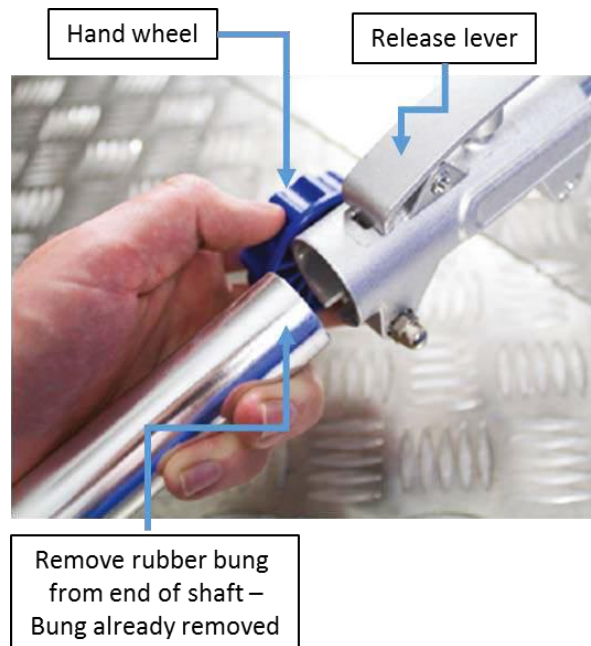

2.10. Fitting/replacing spool line.

Squeeze the bump head unit either side on the grooves and pull to remove the top of the head. Remove the spool, spring and washer from the spindle.

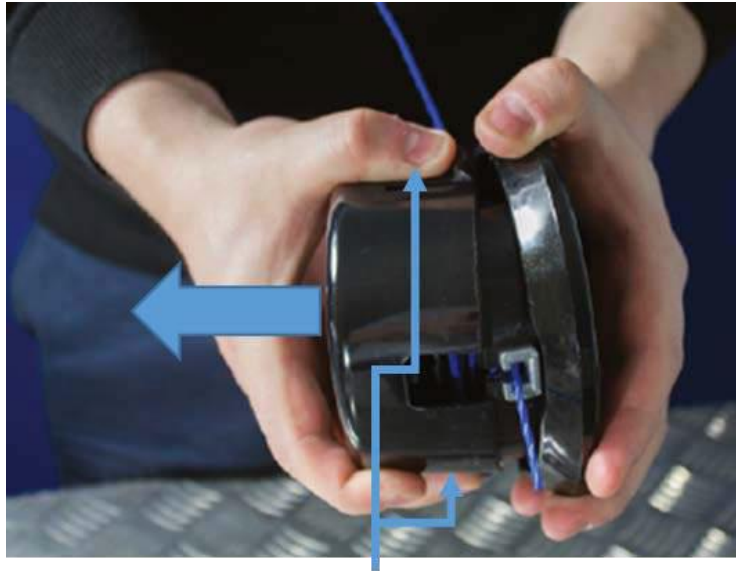

Squeeze head and remove top of head

With the bump feed facing outwards from your left hand, take the looped end and place it around the holder in the middle of the spool as shown below. You will need approximately 3 metres of 2.5 mm of nylon cord

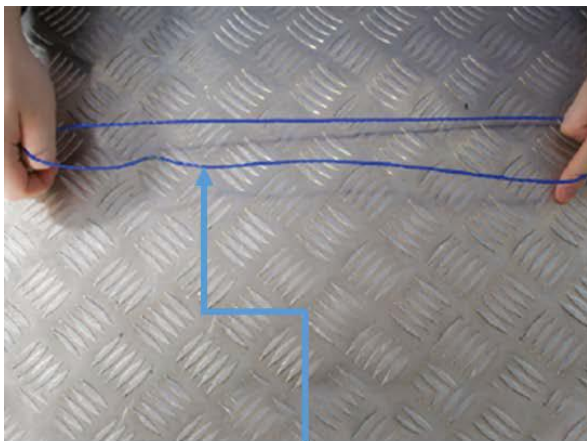

Take cutting line and fold in half



Place the looped end over the spool

Wrap the nylon cord around the spool in an anti-clockwise direction until you have approximately - 150 mm (6"). Then insert spool back into the spindle. Feed the line through the two notches in the spindle and reinsert the washer and spring into the spool. Once complete re-attach the spindle to the cutting head.



Wrap the nylon cord around the spool in an anti-clockwise direction until you have approximately - 150 mm (6").

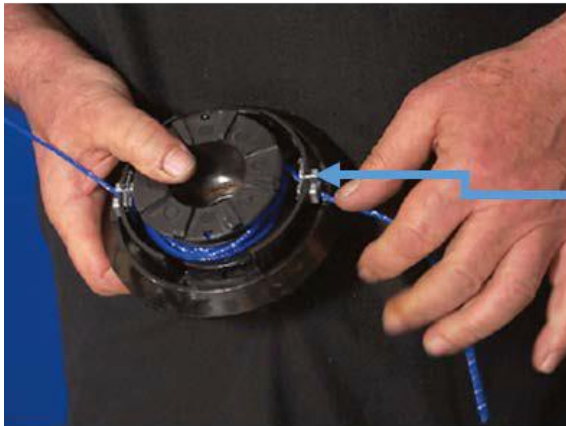

Then insert spool back into the spindle. Feed the line through the two notches in the spindle.



Reinsert the washer and spring into the spool. Once complete re-attach the spindle to the cutting head.

2.11. Face mask assembly.

Rotate to align the tags on the helmet to match the holes on the top of the visor. Place the visor over the tags, then rotate the tags 180° to secure into place. Place the ear defenders over the outside of the headband on the helmet and place into the clips.



2.12. Mixing two stroke oil.

Fill the mixing bottle with fresh unleaded petrol to the fuel level line. For the first fill use the ratio of 25:1 thereafter use a ratio of 40:1.

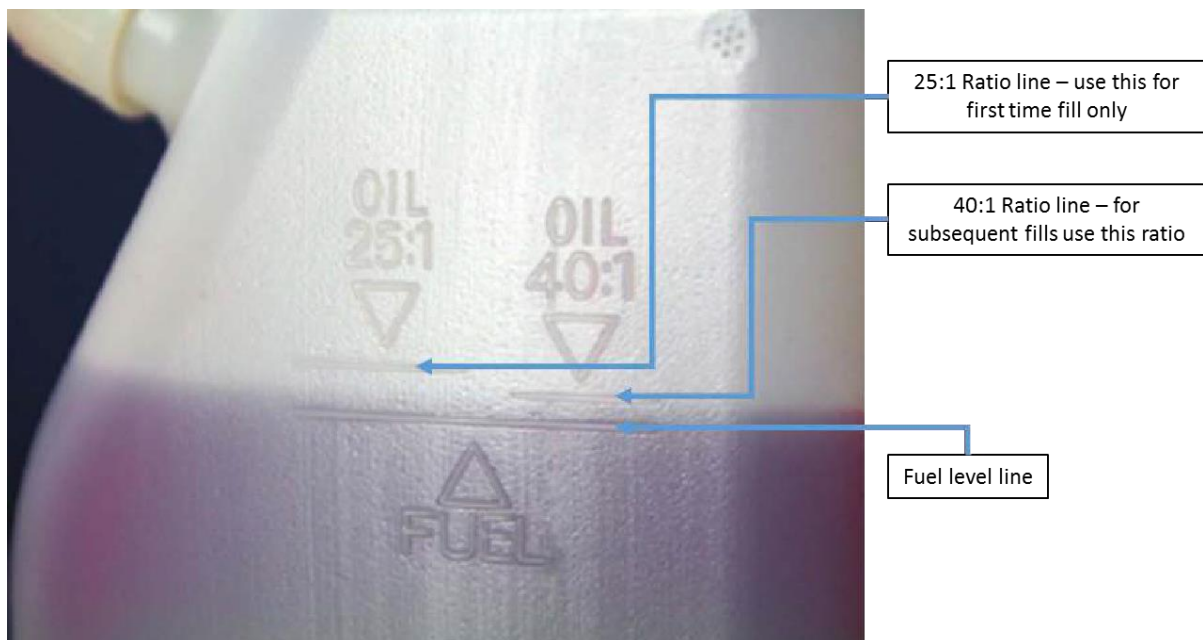

2.13. Adding fuel.

Unscrew the fuel tank cap and carefully add a fuel/2 stroke oil mixture as in section 2.12. DO NOT overfill and allow a 25 mm gap at the top of the tank. Once full replace and correctly tighten the fuelcap.

DO NOT use straight unleaded petrol.



Remove fuel cap

Fill with a Fuel/Oil mixture

3. STARTING PROCEDURE

Fill with fuel/oil mixture, make sure the fuel cap is secure. - Set the ignition switch on the handle to the ON position.



Make sure fuel cap is on and secure

Put ignition switch to the ON position

Pump the primer bulb several times until fuel shows in the bulb.

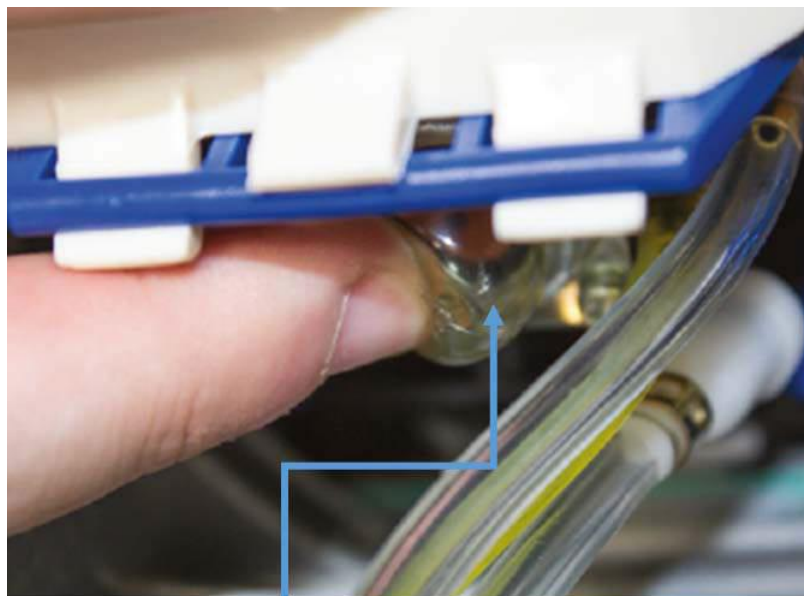

Primer bulb

For COLD start set the choke lever to the ON position by moving upwards as shown.
For a WARM start keep the choke lever at the OFF position.

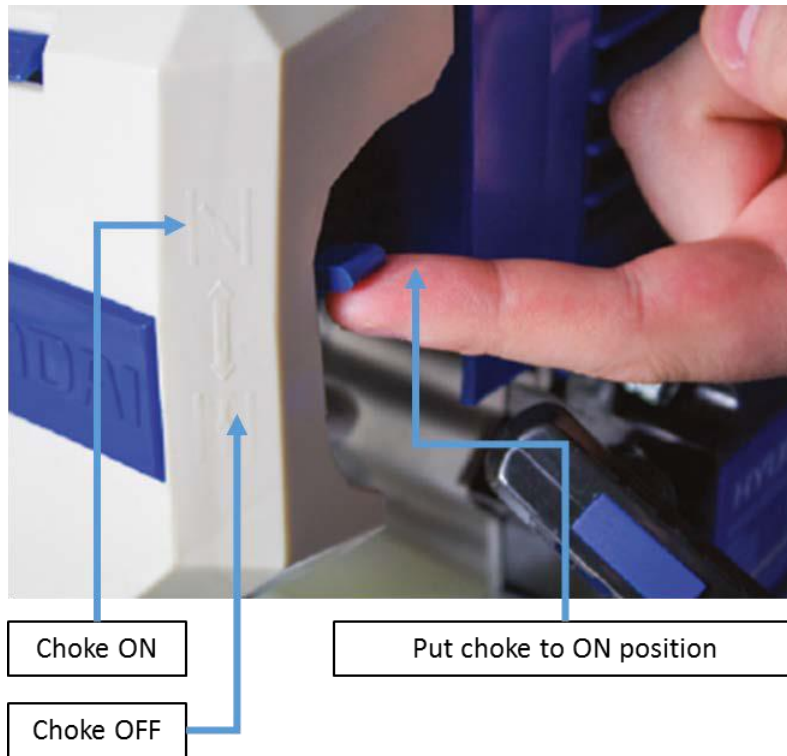

Place one hand on the machine, and using the other hand pull the recoil until you feel a resistance, then pull briskly. Repeat until machine starts. When the machine starts move the choke to the OFF position. DO NOT let go of the recoil handle instead allow the recoil cord and handle return slowly.



Once the engine has started press the throttle lever and throttle safety together. This will accelerate the machine to cutting speed. To lock the throttle press the throttle lock button. To release the throttle lock lightly press the throttle lever.



4. STOPPING PROCEDURE

- 4.1. Before stopping the machine allow the engine to cool down for a few minutes, by allowing it to run without throttle.
- 4.2. You MUST allow the cutting head to come to a full stop before carrying out any maintenance on the machine.

To STOP the machine release the throttle lever and move the ignition switch to the OFF position. If not already in OFF position move the choke to the OFF position.

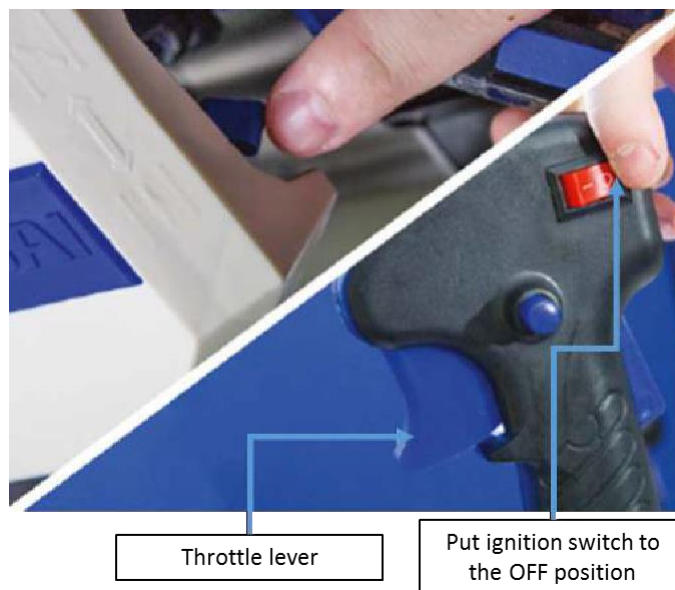

5. USING THE MACHINE

5.1. Before starting work.

5.1.1. YOU MUST check the work area for obstacles such as stones, metal rods or other objects. If these cannot be removed, mark these positions, so you can avoid contact with the trimmer head and objects. Overhead power lines can be caught on the blade head if machine is swirled in the air.

5.2. Accessories.

5.2.1. Make sure that your product is only equipped with original accessories. Only use the machine with original parts which are specified by the manufacturer. The use of any other accessories may cause injury to the user and damage to the machine.

5.3. Wearing the shoulder harness.

CAUTION

When you use this machine always wear the provided harness.

Make sure that the machine is securely hooked onto the strap.

If you do not, you will not be able to control the machine safely.

This may result in injury to yourself or other people.

Never use a harness with any type of defect especially with a defective quick release mechanism.

a. Put the harness on.



b. Connect quick release buckle



c. 1 = Protector Shield and machine hook.

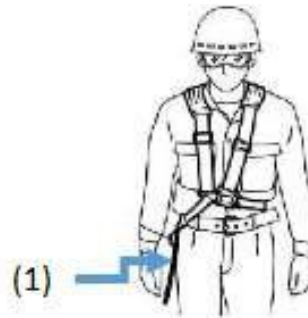

d. Adjust the harness to suit user.



e. 1 = Quick release Harness buckle. Attach machine to harness hook.

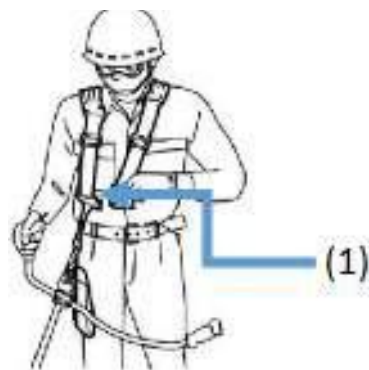

f. The shoulder strap is fitted with a quick release device (see image) fitted. You can remove the shoulder strap quickly by pulling the quick release device.

5.4. Trimming techniques.

CAUTION

If you are not familiar with the trimming, practice with the machine with the machine stopped.

5.4.1. Always trim or cut with the engine running at high speed.

5.4.2. Do not run the machine slowly except for when warming up before use or cooling down after use.

5.4.3. Swing the nylon cutting head of the trimmer horizontally from left to right.



5.4.4. Keep cutting deck parallel with the ground. Do not tilt the nylon cutting or blade head during operation.

5.4.5. For correct cutting height trim a test area in advance.

5.4.6. Keep nylon cutting or blade head at the same level for an even depth of cut.

5.4.7. Nylon trimming head is only to be used for cutting grass.

5.4.8. Metal blade head is only to be used for brush only.

5.4.9. To prevent overheating NEVER over cut, instead cut off smaller lengths of grass or brush. You MUST also remove any tangled materials – You MUST stop the machine and remove the HT lead before carrying out this task.

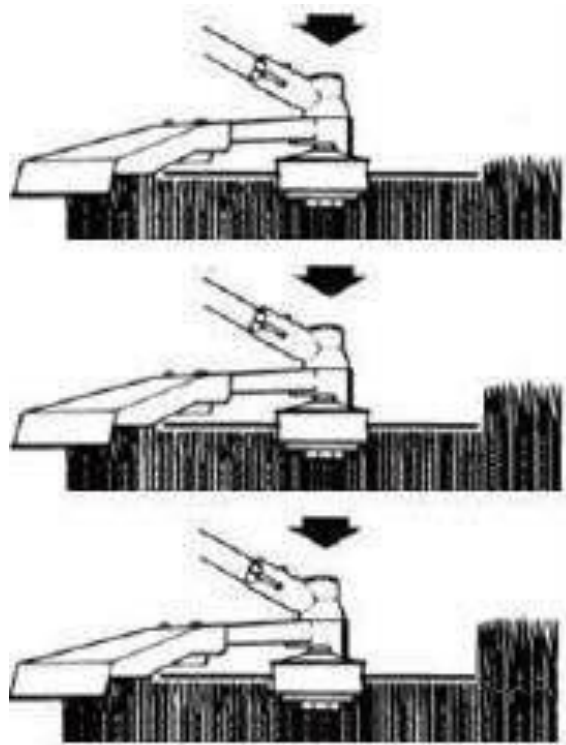

5.4.10. When trimming around trees trim slowly making sure that the nylon cord does not come into contact with the trunk. Walk around the tree from left to right and approach grass with the tip of the cutting nylon cord.

5.4.11. To release more nylon cutting cord run the machine at full throttle and tap the nylon cutting head on the grass. The nylon cord is then released. Any excess cord is cut off by the trimmer blade mounted on the guard. When trimming near brick or stone walls the nylon cord will wear out quicker.

6. MAINTENANCE

WARNING

Always stop the engine and unplug the spark plug before doing any repairs or maintenance.

Never touch the rotating nylon cord or blade.

Check and maintain fuel level regularly, and maintain the fuel/oil mix to the correct ratio.

Frequently check the brush cutter and make sure that all grass deposits are removed from the trimmer head and/or blade

Check the blade, in order to obtain a good cut, the blade should always be sharp and well balanced.

At regular intervals, check the tightness of all nuts, bolts and screws.

If the blade hits an obstacle check for damage and if the machine vibrates badly stop the lawnmower and take it to a service dealer.

CAUTION

Always refuel in a well-ventilated area with the engine off.

Whilst carrying out maintenance you must wear appropriate Personal Protective Equipment (PPE).

Suggested PPE Sturdy footwear, work gloves (especially when working near blade), long trousers and hearing protection.

Component						
		Each use	Every 3 mths or 15 hours	Every 6 mths or 50 hours	Every 12 mths or 100 hours	Every 24 mths or 300 hours
Air filter	Check	o				
	Clean		o a			
Sparkplug	Check/Adjust				o	
	Change					o
Sparkplug electrode	Clean				o	
Cooling fins	Check/Clean			o		
Connections – nuts bolts screws etc.	Check and tighten as required	o				
Coupling	Examine			o b		
Idle	Check/Adjust				o b	
Valve clearance	Check/Adjust				o b	
Spark arrester	Check/Clean	Every 300hours				
Fuel tank	Examine				o	
Fuel pipes	Examine	Each use replace as required				
Bevel gear	Fill	After 25 hours of use (For location of bevel gear grease nipple Section 9 Part Location.				

a = Increase maintenance intervals if operating in dusty environments. b = All maintenance operations - except those listed in the operating instructions, must be performed by qualified service personnel

6.1. Air filter.

⚠ CAUTION

Never let the engine run without the air filter. A dirty air affects the engine performance, increases fuel consumption and makes it difficult to start. If you notice a loss of engine power.

6.1.1. Push clip (1) down and pull filter cover (2) away from machine, take care to release lower clips (3).

6.1.2. Remove the filter (4) by pressing clip (5) and lifting filter clear.

6.1.3. Wash with soap and water. Never use petrol or benzene!

6.1.4. You MUST allow the filter to fully air dry before replacing it on the machine.

6.1.5. To replace the filter reverse the above process.

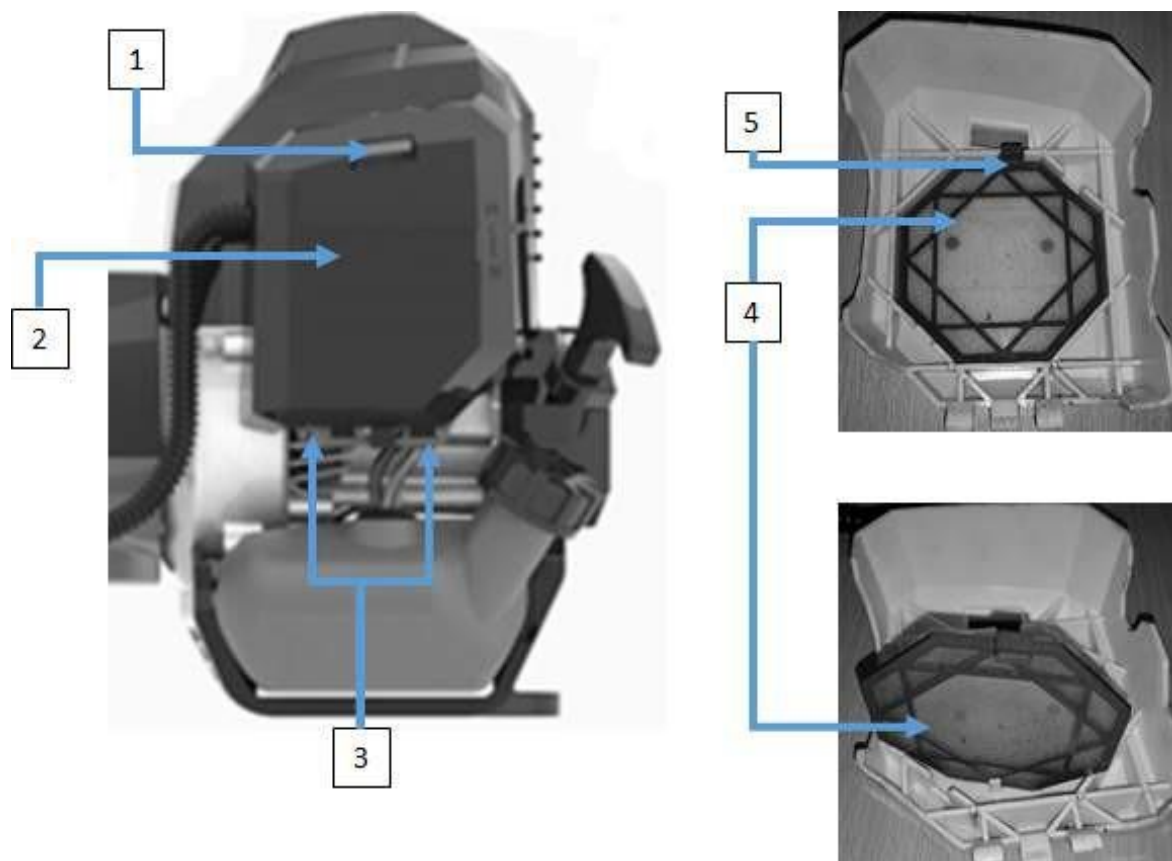

6.2. Spark plug.

WARNING

The spark plug MUST be fully tightened otherwise the engine will overheat causing damage. Always complete the following steps after the engine has been turned off and allowed to cool down.

- 6.2.1. To make sure the engine runs correctly a spark plug gap of 0.6 -0.7 mm must be maintained and the spark plug must be free of carbon deposits.
- 6.2.2. Undo retaining screw (1) and lift spark plug cover (2) clear.
- 6.2.3. Disconnect the spark plug cap (3) carefully. Do not pull on the HT lead instead pull on the spark plug cap (3).
- 6.2.4. Using the supplied spark plug wrench unscrew the spark plug (4) in an anti-clockwise direction.
- 6.2.5. Check the spark plug (4) visually for damage and electrode wear, remove the carbon deposits.
- 6.2.6. Check the gap with a feeler gauge and adjust electrode at the correct gap of 0.6 -0.7 mm.
- 6.2.7. Check the washer (replace as required) of the spark plug. Refit the spark plug by hand to make sure it does not cross thread, tighten the spark plug to a torque of 12/15Nm.
- 6.2.8. Refit the spark plug cap onto the spark plug.

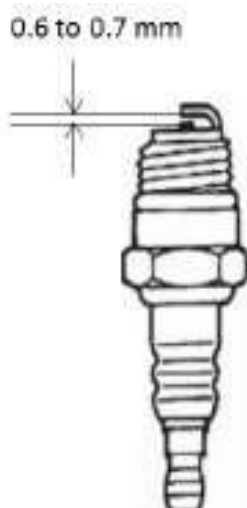
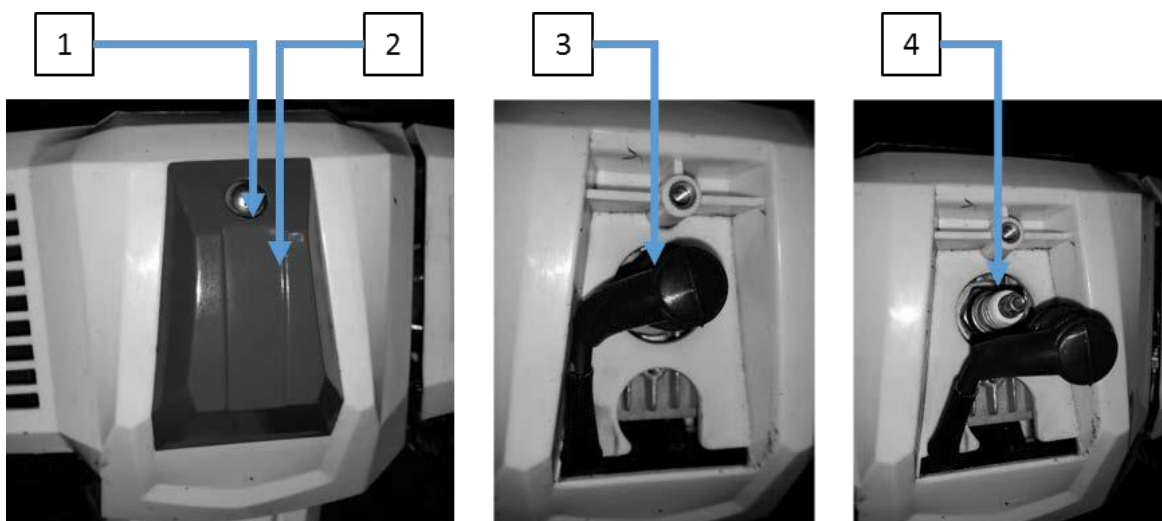

6.3. Trimmer blade sharpening.

WARNING

When sharpening the blade you MUST wear safety gloves.

- 6.3.1. Remove the cutting blade (2) from the shield (1).
- 6.3.2. Put cutting blade securely into a vice.
- 6.3.3. Sharpen the blade with a suitable flat file.
- 6.3.4. Please make sure that you maintain the angle of cutting. Maintain the original cutting angle.

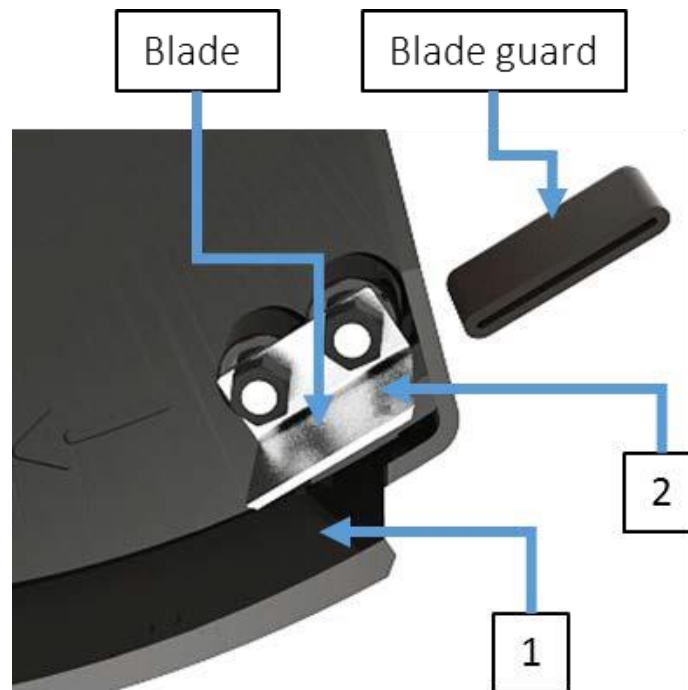

6.4. Storage.

WARNING

If you do not follow these steps, deposit may arise in the carburetor. This will cause starting difficulties and may cause permanent damage.

- 6.4.1. Perform all the general maintenance that the maintenance section of your 'User Manual' is recommended.
- 6.4.2. Clean the outside of the machine, drive axle, shield and nylon cutting head.
- 6.4.3. Remove all fuel from the fuel tank.
- 6.4.4. After all the fuel is drained, start the engine.
- 6.4.5. Allow the engine to run in idle until engine stops alone. This allows the fuel to be removed from the carburetor.
- 6.4.6. Allow engine to cool down (about 5 minutes).
- 6.4.7. Use a spark plug wrench, remove the spark plug.
- 6.4.8. Pour 1 teaspoon of clean 2-cycle oil into the combustion chamber. Slowly pull the starter rope several times to coat internal components. Replace the spark plug.
- 6.4.9. Store the machine in a cool, dry place away from any source of ignition such as an oil burner, water heater etc.

6.5. Transporting the machine.

- 6.5.1. When transporting the machine make sure that no fuel is allowed to leak out.
- 6.5.2. DO NOT allow the trimmer/brush cutter come into contact with persons, animals and property.

7. TROUBLESHOOTING

CAUTION

7.1. If troubleshooting does not solve the problem, contact your dealer or the manufacturer directly. Use only original parts approved by the manufacturer, otherwise a hazard risk arises.

NO SPARK.

Possible causes;

1. Carbon deposit between electrodes of the spark plug.
2. Ignition coil defective flywheel magneto too weak.

Possible corrective actions;

1. Clean the spark plug. Adjust the gap to 0.6~0.7mm, Replace the spark plug.
2. Replace the Ignition coil or the flywheel.

WEAK SPARK.

Possible causes;

1. Too much fuel in the combustion chamber, poor fuel or water in tank.
2. Blocked fuel line

Possible corrective actions;

1. Remove spark plug and dry, replace fuel.
2. Clean the carburetor and clean the lines.

NORMAL FUEL SUPPLY BUT WEAK COMPRESSION

Possible causes;

1. Worn piston rings, spark plug not tightened, the cylinder head is not tightly wrong valve clearance or ignition.

Possible corrective actions;

1. Replace or adjust.

NORMAL FUEL SUPPLY AND POOR SPARK

Possible causes;

1. Poor contact between spark plug cap and spark plug.

Possible corrective actions;

1. Check or exchange.

MOTOR DOES NOT COME UP TO SPEED

Possible causes;

1. Choke is in "cold start" position, exhaust system does not clog air supply, worn Movable elements, spark weak, valve clearance to big, sooty cylinder head.

Possible corrective actions;

1. Open choke, exhaust system ignition coil exchange check or replace flywheel Adjust spark plug.

POWER RUNS OUT

Possible causes;

1. Congested fuel lines to the carburetor. Spark plug gap incorrect.

Possible corrective actions;

1. Unblock/Replace fuel lines and carburetor. Reset spark plug gap.

NOISY ENGINE

Possible causes;

1. Incorrect choke lever position, or damage to crankshaft.

Possible corrective actions;

1. Check and correct choke lever position. Check and/or replace crankshaft.

LEAKING CARBURETOR

Possible causes;

1. Failure of the non-return valve on the fuel tank lid. Worn carburetor gasket.

Possible corrective actions;

1. Replace the fuel cap. Replace the carburetor seal.

8. SPECIFICATION.

	MODEL	HYBC5080AV
ENGINE	Engine type	Single cylinder, 2 stroke, air cooled.
	Engine size - cc	50.8
	Fuel tank capacity - ml	800
	Noise level dB (A)	115
	Max speed - rpm	7500
	Power - kw	1.56
	Start method	Recoil
	Fuel type/ratio	Fresh unleaded petrol mixed with Semi-synthetic 2 Stroke oil first use ratio 25:1 - thereafter use ratio of 40:1
	Drive type	Centrifugal clutch
MACHINE	Bevel gear - grease type/qty ml	High temperature gear grease/25
	Head line length/diameter - mm	3000/2.5
	Cutting width mm /length mm /diameter mm	255mm for cutter blade / 400-450 for cutter head (Blade 1.6mm/3T
	Gross weight - kg	13.68
	Dry weight kg	9.68
	Fully assembled dimensions L x W x H - mm	1820 x 750 x 500

9. PART LOCATIONS.

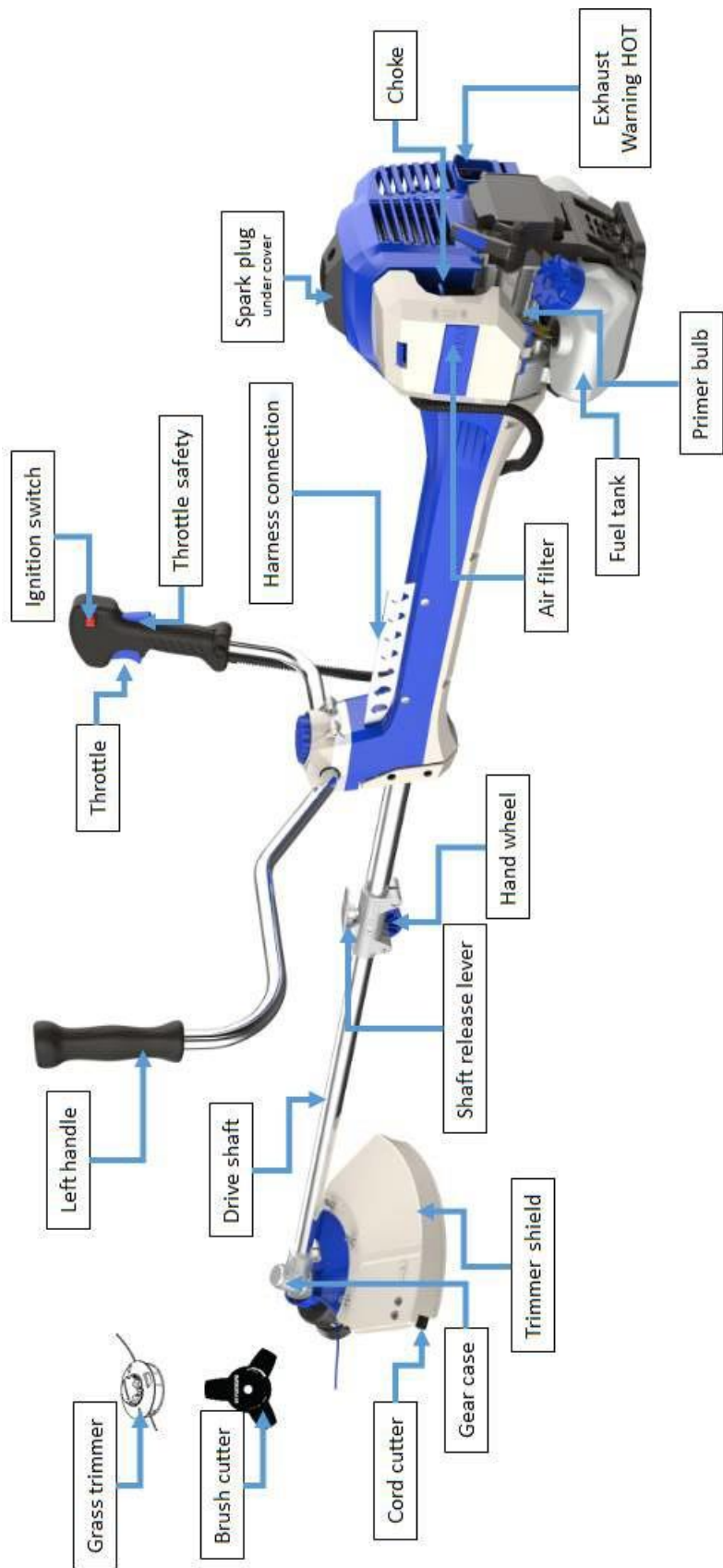

10. DECLARATIONS OF CONFORMITY

EC Declaration of Conformity

We hereby declare that the machine detailed in this declaration complies to all the relevant provisions of the following EC directives.

- 2006/42/EC The Machinery Directive
- 2014/30/EU Annex II Electromagnetic Compatibility Directive
- 2016/1628/EC The Emission of Gaseous and Particulate Pollutants from internal Combustion engines
- 2000/14/EC Noise Emissions in the Environment by Equipment for use Outdoors.

And is in conformity with the applicable requirements of the following documents:

- EN ISO 11806-1:2011
- EN ISO 10517:2019

Declaration for 2000/14/EC Noise Emissions in the Environment by Equipment for use Outdoors.

Notified Body for EC Directive 2000/14/EC TÜV Rheinland (Shanghai) Co., Ltd.

Model	Type	Engine Size	Measured Sound Power	Guaranteed Sound Power	Engine output
HYBC5080AV	Petrol Brushcutter	50.8cc	113.99dB(A)	117dB(A)	1.7kW

Product Details

Brand : Hyundai

Model : HYBC5080AV

Description : Petrol Brushcutter

Name and address of technical documentation holder and EU distributor:

Genpower Ltd, Isaac Way, Pembroke Dock, Pembrokeshire, SA72 4RW, UK.

Signed by:



Roland Llewellyn, Managing Director

Date : 21/04/2020

11. RECYCLING & PRODUCT DISPOSAL

11.1. We do not offer a takeback scheme for the recovery of Waste Electrical Electronic Equipment (WEEE) & Batteries instead the responsibility to dispose of WEEE and or Batteries is passed onto you by us. So when it becomes necessary to dispose of your machine you must take it to your local Civic

11.1.1. Certain products contain WEEE waste which should not be disposed of in your domestic waste.



11.3.2. You MUST recycle WEEE in accordance with your local authority or recycling centre.

11.4. Battery recycling, certain products contain batteries which should not be disposed of in your domestic waste.



11.4.1. You MUST recycle batteries in accordance with your local authority or recycling centre.

11.5. Unwanted packaging materials should be sorted and taken to a recycling centre so it can be disposed of in a manner which is compatible with the environment.

11.6. The following symbol means that you should 'Reduce – Reuse – Recycle'.



11.7. We are a Member of the VALPAK National Compliance scheme and our registration number is RM08660

11.8. For further information about disposal please contact your Local Authority.

11.9. You can also get more advice and guidance about recycling at the following website <http://www.recycle-more.co.uk>

Amenity Site. For further information please contact your Local Authority for disposal advice.

11.2. You MUST make sure that all unused oil and fuel is disposed of correctly either beforehand or at your local Civic Amenity Site. Under NO circumstance must any oil and fuel be put down any drains.

11.3. Waste Electrical Electronic Equipment (WEEE) recycling.

11.3

11.10. Should you pass this product onto another user either sold or loaned you MUST pass on this user manual. This will make sure that all other users can use and maintain the machine safely.



12. CONTACT DETAILS

POSTAL ADDRESS

Genpower Ltd, Isaac Way, London Road,
Pembroke Dock, Pembrokeshire, SA72 4RW.
UK.

TELEPHONE

+44 (0) 1646 687880

FAX

+44 (0) 1646 686198

TECHNICAL E-MAIL

aftersales@hyundaipowerproducts.co.uk

WEBSITE www.hyundaipowerproducts.co.uk

13. MANUAL UPDATES

13.1. Our manuals are constantly being reviewed and updated. Should you find an error, omission or something you find unclear please contact your dealer for assistance. E&OE.

13.2. Our latest manuals are also placed online.

13.3. We reserve the right to make any modifications without prior notice whenever necessary.

14. WARRANTY

14.1. Proof of purchase will be required before you make a warranty claim.

Full warranty terms and conditions can be found on the HYUNDAI POWER PRODUCTS website:
www.hyundaipowerproducts.co.uk

HYUNDAI

POWER PRODUCTS

Importer:

GENPOWER LTD

Isaac Way, London Road

Pembroke Dock, UNITED KINGDOM, SA72 4RW

T: +44 (0) 1646 687 880 F: +44 (0) 1646 686 198

E: info@hyundaipowerproducts.co.uk

www.hyundaipowerproducts.co.uk

Imported/Distributed by GENPOWER LTD for The United Kingdom & Ireland

Licensed by Hyundai Corporation, Korea