



Operator's Manual

user manual, maintenance instructions and spare parts

25C-SP Grass Trimmer



Read this manual carefully before operating the machine
Original Instructions Version July 15

PRODUCT DESCRIPTION

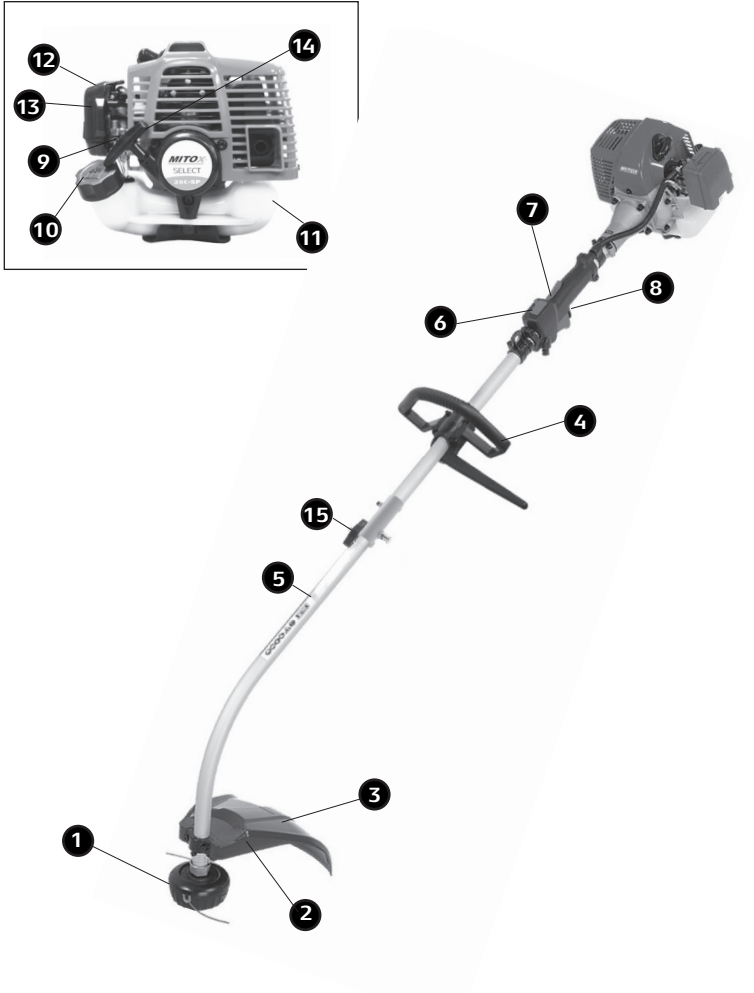

This Grass Trimmer is a 2 stroke fast running power tool and is designed to be used in a domestic application for trimming new growth.

Component Location

1	NYLON CUTTER HEAD	CONTAINS REPLACEABLE NYLON TRIMMING LINE
2	CUT-OFF KNIFE	TRIMS NYLON FILAMENT TO THE CORRECT LENGTH
3	SHIELD	MOUNTED JUST ABOVE THE CUTTING ATTACHMENT HELPS PROTECT THE OPERATOR
4	D-HANDLE	CAN BE ADJUSTED AT YOUR CONVENIENCE FOR COMFORT
5	DRIVE SHAFT ASSEMBLY	CONTAINS A FLEXIBLE DRIVE SHAFT
6	IGNITION SWITCH	ON AND OFF SWITCH
7	SAFETY LEVER	TO PREVENT ACCIDENTAL OPERATION OF THE THROTTLE
8	THROTTLE TRIGGER	SPRING LOADED TO RETURN TO IDLE WHEN RELEASED
9	PURGE BULB	PUSH THE PURGE BULB TO REMOVE THE AIR FROM THE FUEL SYSTEM
10	FUEL CAP	
11	FUEL TANK	CONTAINS FUEL AND FUEL FILTER
12	AIR FILTER COVER	CONTAINS REPLACEABLE FELT ELEMENT
13	CHOKE	TO HELP IN COLD STARTING
14	STARTER HANDLE	PULL TO START THE ENGINE
15	COUPLING	JOINS THE POWER UNIT TO THE GRASS TRIMMER ATTACHMENT

Warnings in the Manual



This mark indicates instructions which must be followed in order to prevent accidents which could lead to serious bodily injury or death.













This mark indicates instructions which must be followed or it leads to mechanical failure, breakdown, or damage.



This mark indicates hints or useful directions in the use of the product.

Safety Symbols

<p>Warning: Danger, Caution</p>	
<p>Read the documentation and safety instructions which are provided in this user manual.</p>	
<p>When operating this machine, use protective equipment such as goggles, helmet and ear defenders.</p>	
<p>Wear security shoes and gloves.</p>	
<p>Check the condition of the working area to avoid any accident by hitting hidden obstacles such as stumps, stones, cans, or broken glass.</p>	
<p>Hot surface: Risk of burn.</p>	
<p>Danger: Risk of intoxication.</p>	
<p>Danger: Risk of fire or explosion</p>	
<p>Directive 2000-14/CE. Guaranteed noise levels</p>	
<p>Beware of objects being thrown from the operating zone</p>	
<p>Warning: Keep all people, animals and vulnerable objects at least 15 metres from the working area.</p>	

<p>Never modify the cutter in any way. Improper use of any cutter can cause serious or fatal injury.</p>	
<p>Not for use with metal blades.</p>	

Taking Care of Warning Labels

Always keep warning labels clean and free of scratches, which might make them illegible or difficult to read. If the warning labels provided with your grass trimmer become damaged, peel off, or otherwise become illegible or difficult to read, order new labels from the authorised servicing dealer and replace the damaged labels. When applying new labels, first wipe away any dirt and dry the surface before applying the new label in the same place as the original label.

Explanation of Symbols on the Machine

For safe operation and maintenance, symbols are carved in relief on the machine:



FUEL TANK

Fuel tank 2 stroke mix
Position: Fuel cap



CHOKE OPERATION

Starting mode when the engine is hot (choke off).
Position: Air cleaner cover.



Starting mode when the engine is cold (choke on).
Position: Air cleaner cover.

Safety Precautions

Introduction

Read this Owner/Operator Manual carefully. Be sure you understand how to operate this grass trimmer properly before you use it. Failure to do so could result in serious injury.

Keep this manual handy so that you may refer to it later whenever any questions arise. Also note that you are able to contact the dealer from whom you purchased the product for assistance.

Always include this manual when selling, lending, or otherwise transferring the ownership of this product.

This product has been designed to be used as a grass trimmer power tool as described previously and it should never be used for any other purpose; doing so could result in unforeseen accidents and injuries occurring. Only approved Mitox accessories should be used with this product.

When using this grass trimmer for the first time, take the grass trimmer to a wide, clear, open space, start the engine, and practice handling the grass trimmer until you are sure that you will be able to handle it properly in actual operation.

You should never use this grass trimmer when under the influence of alcohol, suffering from exhaustion or lack of sleep, suffering from drowsiness as a result of having taken medicine, or at any other time when your judgement might be impaired or that you might not be able to operate the grass trimmer properly and in a safe manner.

Never allow children or anyone unable to fully understand the directions given in this manual to use this grass trimmer.

When planning your work schedule, allow plenty of time to perform the work and allow plenty of time for rest. Limit the amount of time you continuously use the grass trimmer to 30~40 minutes per session and take 10~20 minutes of rest between work sessions. Also, try to keep the total amount of work performed in a single day to 2 hours.

Never run the engine indoors as the exhaust gases contain harmful carbon monoxide.

Never use the grass trimmer in conditions as described below:

When the ground is slippery or when other conditions exist which might make it difficult to maintain a steady posture while using the grass trimmer.

At night, at times of heavy fog, or at any other times when your field of vision is limited and it would be difficult to gain a clear view of the area where the grass trimmer is to be used. In heavy rain, during lightning storms, at times of strong or gale-force winds, or at any other times when weather conditions might make it unsafe to use this product.

Lack of sleep, tiredness, or physical exhaustion results in lower attention spans, and this in turn can lead to accidents and injury.

Work Clothing and Safety Equipment

When using the grass trimmer, you should wear proper clothing and protective equipment.

- Helmet
- Protection goggles or face protector
- Ear protectors
- Thick work gloves
- Non-slip sole work boots
- When using your grass trimmer, always wear strong, durable, work clothing; shirts should be long-sleeved and trousers should be full-length.

Safety and Operation



This grass trimmer is equipped with a very sharp blade.

Improper handling can cause accidents which may in turn lead to serious injury or death. For this reason, you should always be careful to adhere to the following instructions when using your

grass trimmer.

Never hold the grass trimmer in a way in which the cutting head is pointing towards someone else.

Never allow the cutting head to come into contact with your body.

Always turn off the engine before adjusting the grass trimmer, or at any time when coming into close proximity with the cutting head.

Always wear thick work gloves when adjusting the grass trimmer.

Safe Handling of Fuel



The engine of the grass trimmer is designed to run on a two stroke oil/fuel mixture.

This fuel is highly flammable, never store cans of fuel or refill the fuel tank in any place where there is a source of heat or fire, which might ignite the fuel.

Do not smoke whilst operating the grass trimmer or refilling, keep lit cigarettes away from the grass trimmer at all times.

When refilling the fuel tank always stop the engine first and carefully make sure that there are no sparks or naked flames anywhere nearby before refuelling.

If any fuel spillage occurs during refuelling, use a dry rag to wipe any fuel which has been spilled onto the grass trimmer before starting the engine.

After refuelling, screw the fuel cap back tightly onto the fuel tank and carry the grass trimmer to a spot 5 metres or more away from where it was refuelled before starting the engine.

Before Operating the Grass Trimmer

Before beginning work, carefully check the work area and remove any obstacles. Within a perimeter of 15 metres of the work area should be considered a hazardous area into which no one should enter while the grass trimmer is being used, and when necessary this area should be marked with a warning rope, warning signs, or other forms of warning.

When work is to be performed simultaneously by two or more operators, care should also be taken to constantly look around to check the presence and locations of other operators within the work area to maintain a safe distance between each operator.

Before beginning work, each component of the grass trimmer should be checked to make sure that it is in proper working order, make sure that there are no loose screws or bolts, fuel leaks, ruptures, dents, broken guards or any other problems which might interfere with safe operation.

Keep all parts of your body away from the cutting head when the engine is running.

Before Starting the Engine

Carefully check the work area to make sure that no obstacles exist within a perimeter of 15 metres around the grass trimmer before starting the engine.

To start the engine, place the grass trimmer onto the ground in a flat clear area and hold it firmly in place to ensure that neither the cutting head nor the throttle come into contact with any obstacles when the engine starts.

After starting the engine, make sure that the cutting head stops moving when the throttle trigger is released (idle). If the cutting head continues to move when the engine is at idle, adjust the idle screw on the carburettor to a point where the cutting head stops moving, if this cannot be achieved, take the grass trimmer to your authorised service dealer for adjustment.

Avoid Noise Problems

Check and follow the local regulations for sound levels and hours of operation for garden machinery.

In general, operate grass trimmers between 8 am and 5 pm on weekdays and 9 am to 5 pm at weekends.

Avoid using the grass trimmer late at night and/or early in the morning.

Safety when using the Grass Trimmer

When using the grass trimmer, grip the handles firmly with both hands, place your feet slightly apart so your weight is distributed evenly across both legs, and always maintain a steady even posture while working.

- Maintain full engine speed when cutting.
- Never allow other persons to come within the work area as doing so might expose them to danger.
- Keep work area clear of all persons, particularly small children and pets. Injury may result from flying debris.
- If grass or other objects get caught in the grass trimmer during operation, always stop the engine before removing the object.
- Never touch the spark plug or plug HT cable while the engine is in operation, doing so may result in an electrical shock.
- Never touch the exhaust, spark plug, or any metallic parts while the engine is in operation or immediately after shutting down the engine. These parts reach high temperatures during operation and doing so could result in serious burns.
- When you finish cutting in one location and wish to continue work in another area, stop the engine.
- Always remove fuel from the fuel tank before transportation to prevent fuel spillage.
- Never leave the grass trimmer exposed to direct sunlight as this can heat the fuel tank and may cause a discharge of fuel, and flood the engine.
- Be careful not to hit the nylon cutting head against stones or the ground.



Two-Stroke Fuel



Fuel is very flammable. Do not smoke or bring any flame or sparks near fuel.

Always stop the engine and allow it to cool before refuelling.

Refuel outdoors on bare ground, restart engine at least 5m away from the refuelling stop.

The engine is lubricated by oil mixed into petrol. Prepare a mixture of unleaded petrol and semi-synthetic two-stroke oil that meets the specifications of: API TC, ISO-L-EGC, JASO FC (Low Smoke) oil.

Recommended mixing ratio is 40:1.

FUEL WITH NO OIL (RAW PETROL) will cause severe damage to the engine which is not covered by the manufacturer's warranty.

Use fresh, unleaded petrol (90 RON) and semi-synthetic oil specially made for high performance two-stroke engines. Mix in a ratio of 40 parts petrol to 1 part of oil.

By using two-stroke oil specially made for two-stroke engines you will reduce the formation of ash and carbon deposits on the spark plug, piston, exhaust muffler and cylinder as well as reducing emissions of harmful exhaust gases.

Oil FOR 4-CYCLE ENGINES should not be used as two-stroke lubrication oil as it can cause fouling of the spark plug, exhaust port blocking, piston ring sticking and other internal engine damage.

NOTE

Due to increased Ethanol content in petrol we recommend the use of B3C Ethanol Shield 2-Stroke Oil, or Ethanol Shield Fuel Stabiliser to protect your MITOX® engine against the harmful effects of Ethanol.

Visit www.b3cfuel.co.uk for more information.



Fuel Storage

Mixed two-stroke fuel (without Ethanol Shield) which has been left unused for a period of one month or more may damage the carburettor and result in the engine failing to start or operate correctly.

When storing the grass trimmer for a period of more than one month, empty the fuel tank, and run the engine to empty the carburettor of fuel.

Two stroke fuel can cause deterioration of rubber and/or plastic components during prolonged storage.

It is important to only use good quality, fresh fuel mix.

Fuelling

Shake the fuel container to thoroughly mix the two-stroke oil and petrol.

Clean dirt from around the fuel cap before removing.

Pour two-stroke fuel into the fuel tank with a filtered funnel, up to 80% of the fuel tanks capacity.

Replace the fuel cap and tighten securely. Spilled fuel must be wiped away from the grass trimmer before starting the engine.

Move at least 5m away from the refuelling area before restarting the engine.



When refilling the tank, always turn off the engine and allow it to cool down. Take a careful look around to make sure that there are no sparks or open flames anywhere nearby before refuelling.

Assembly of the Grass Trimmer



The blade fitted to the guard is sharp and can cause injury, always wear gloves.

Installing the Guard

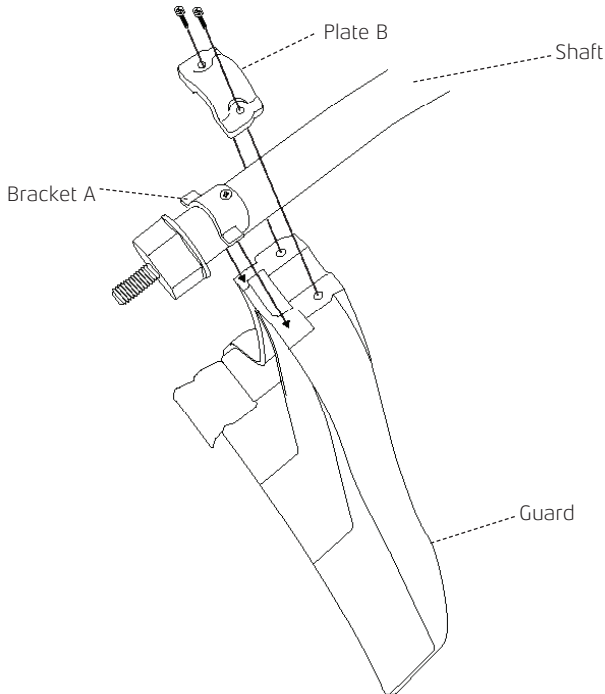

To install the guard to the shaft, locate the shield using bracket A as a locating point, and secure using plate B and 2 screws.

Installing the Loop Handle Assembly (L Models)

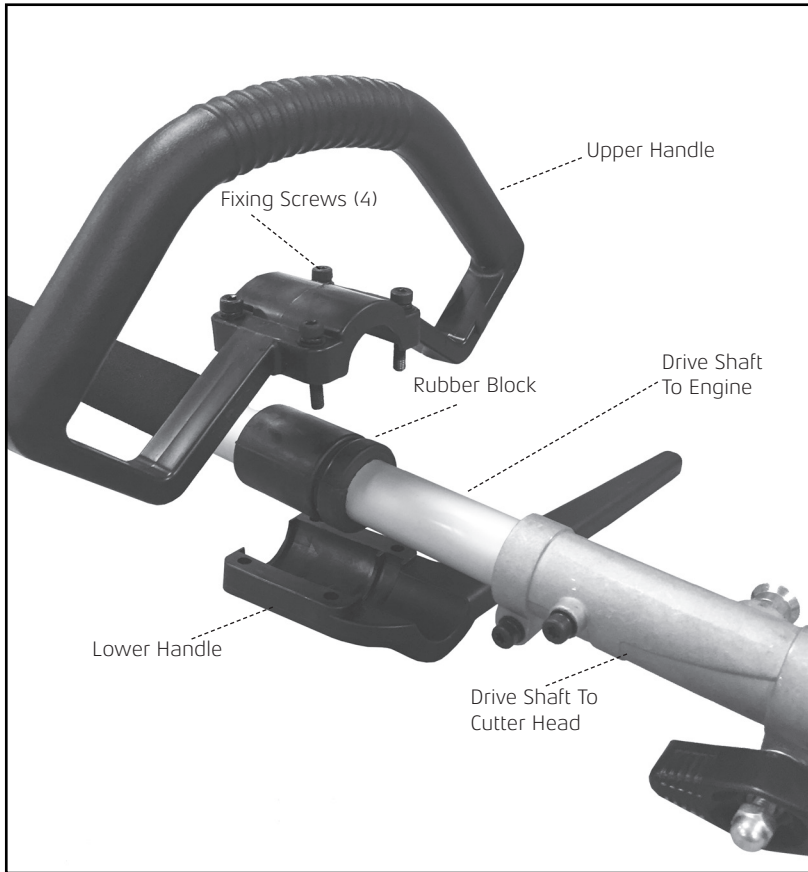

- Fix the loop-handle to the shaft over the rubber block provided. Adjust to a comfortable working position then tighten the fixing screws securely.

Installing the Nylon Head

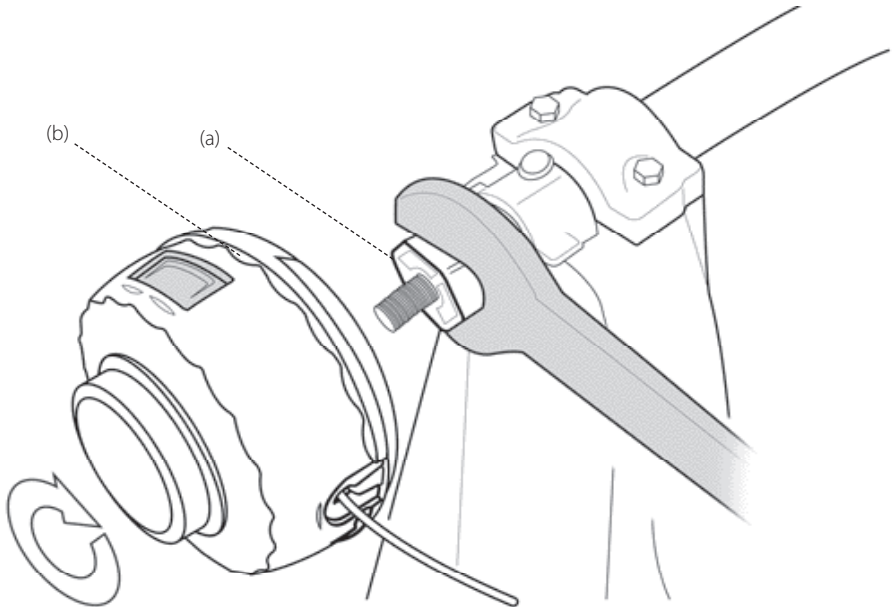

- Hold the dust cover (a) with the spanner supplied to stop the shaft rotating and screw the trimmer head (b) clockwise onto the drive shaft until tight.

Installing the Curved Shaft Attachment

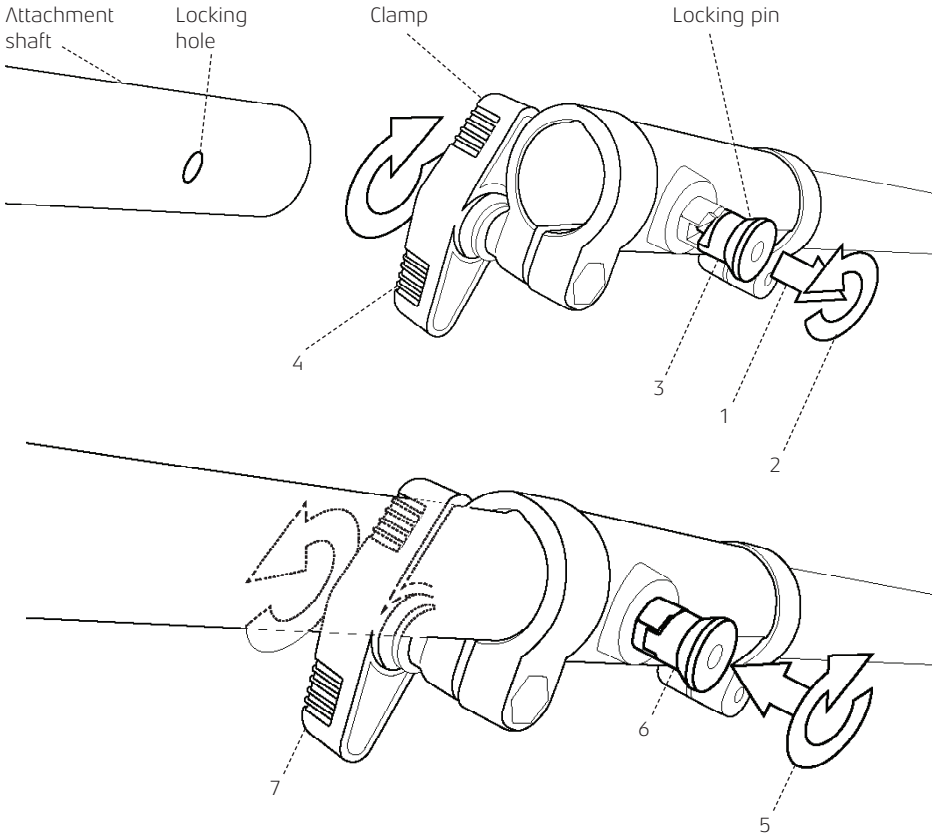

- Pull out the locking pin (1) and twist (2) to lock in the outer position (3).
- Loosen the clamp by turning the handle (4).
- Insert the attachment shaft, lining up the locking hole with the locking pin .
- Twist the locking pin (5) to release it from the outer position. You may need to twist the attachment shaft to ensure that the locking pin engages with the locking hole (6).
- Tighten the clamp by turning the handle (7).

Using the Grass Trimmer

Nylon Head

- Cut the grass in 1.5 metre widths, keeping the machine well balanced.
- Avoid engaging stones, piles of earth, small pieces of wood or anything that could be hidden or difficult to see in the grass. If a large object is accidentally struck, if the cutting head gets blocked, overloaded or stringy material gets wrapped in the cutting head, reduce the engine speed so the engine idles. Make sure that the cutting head has stopped rotating, switch off the engine and remove the material.
- Put the grass trimmer on the ground and check that the cutting head has not been damaged. If necessary, change the cutting head. If the head is only wrapped by vegetation, remove by hand and clean the cutting head.
- Always wear safety gloves for this operation and ensure the engine is switched off and the head is stationary.
- When the 2 nylon cords become too short, accelerate the engine and bump the nylon head on the ground. Automatically the 2 nylon cords will feed out and be cut to the correct length. Repeat the operation if necessary.

Operation  **WARNING**

Keep clear of the cutter head as it may start moving when the engine starts.

Starting the Engine

CAUTION do not pull the starter cord all the way out and do not let go of the starter handle when the cord is extended, this can damage the starter mechanism.

Cold Engine Starting

Rest the unit on a flat, firm surface. Keep the cutting head off the ground and clear of surrounding objects as it may start moving when starting the engine. Set the throttle to “fast idle” as follows (1) Depress and hold the safety lock lever. (2) Squeeze and hold the throttle lever. (3) Depress the throttle lock button (Fig 3 -e). (4) While holding down the throttle lock button, release the throttle lever and safety lock lever. (5) Release the throttle lock button.



Fig 1 - Push the air purge bulb (a) until fuel is visible in the clear return fuel line (b)

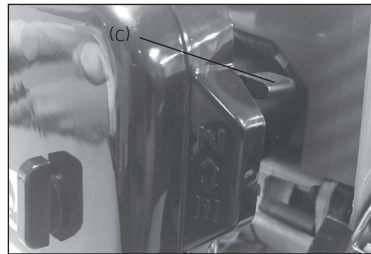

Fig 2 - Move the choke lever (c) to the closed (I) position.

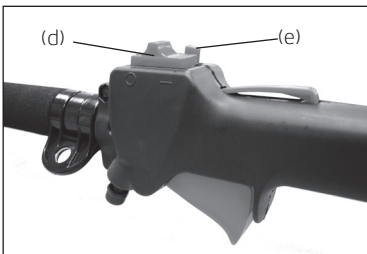

Fig 3 - Set the ignition switch (d) to the START (I) position. (e) is the throttle lock button.

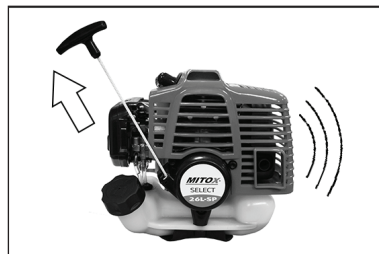

Fig 4 - While holding the unit, pull out the starter rope firmly until engine fires (indicated by a ‘cough’ from the engine).

25C-SP Grass Trimmer

MITOX[®]

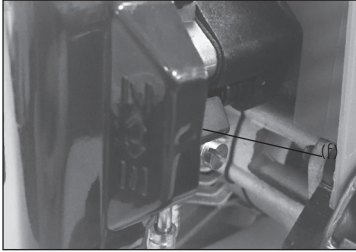



Fig 5 - Move the choke lever (f) to the open () position.



Fig 6 - Pull the starter rope until the engine starts, then squeeze the throttle briefly to release the fast idle control and return the engine to idle.

Allow the engine to warm up before use. When cutting, always use the Grass Trimmer on full throttle.

NOTE Avoid pulling the rope to its full travel or releasing the recoil handle when the recoil rope is extended. Such actions can cause starter failure.

Hot Engine Starting

- Set the ignition switch to the START (I) position.
- Check the clear return fuel line. If the line is empty, push the air purge bulb until fuel is visible in the clear return fuel line.
- Pull the starter rope until the engine starts.
- If the engine does not start after 5 pulls, use the Cold Start procedure.

Overchoking

Should the engine become flooded due to overchoking, turn the ignition switch off, unscrew the spark plug, wipe it dry or replace.

Stopping the Engine



NOTE

Set the engine to idling by releasing the throttle lever.

Set the ignition switch to the off position "0" (STOP).

If the engine fails to stop, set the choke lever to the closed position to stall the engine; do not use the machine until the ignition switch is repaired.

Running In

During the first ten hours of work, avoid running the engine at maximum speed for a prolonged period until all the components have bedded in, after the engine has been run in, it will reach its maximum power.

Transportation

Never transport the Grass Trimmer with the engine running. An engine that is running could be accidentally accelerated causing the blade to engage.

Make sure the blade safety guards are in place when transporting the Grass Trimmer.

When carrying by hand, the cutting head should be pointing backwards.

Ensure the Grass Trimmer is secure when transporting in a vehicle and the tank is drained of fuel.

Maintenance

IMPORTANT

After every use, check that all nuts, bolts and screws are securely fastened and tighten if necessary.

In the event of an accident, breakdown or blockage, ensure the engine is turned off before any work is carried out to rectify this.

Make sure the engine has stopped and is cool before performing any service to the machine.

Contact with moving cutting head or hot muffler may result in a personal injury.

Fuel Filter

Every 15 hours of operation, using a wire hook, take the fuel filter from the fuel tank and clean or replace with a new fuel filter.

Spark Plug

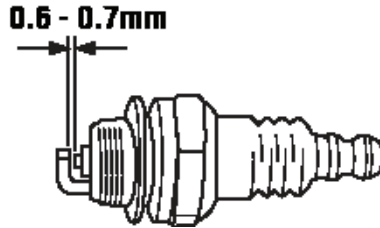

Poor starting or misfiring is often caused by a fouled or defective spark plug, clean and reset the gap to 0.65 mm, or replace the spark plug with BPMR7A as necessary.

Air Filter

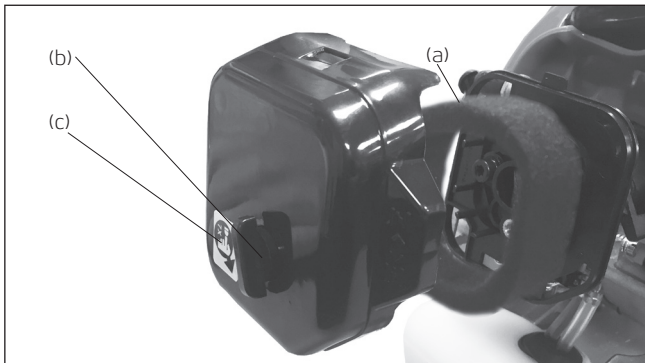

Before using the grass trimmer, check the air filter (a). Being clogged, will reduce the engine performance.

Remove the air filter cover by unscrewing the filter cover release (b) and opening the filter cover (c). clean the filter element in warm, soapy water, dry completely before installing. If the element is broken or shrunk, replace with a new one.

Carburettor



The carburettor mixture setting has been set at the factory and will not need adjusting.

Adjusting the idle speed: If adjustment is necessary turn the T screw (a) clock wise until the cutting head starts to move, then turn the screw T anticlockwise until the cutting head stops.

If the idle speed cannot be adjusted to stop the cutting head moving at idle, contact your dealer for repair before use.

Safety Lock

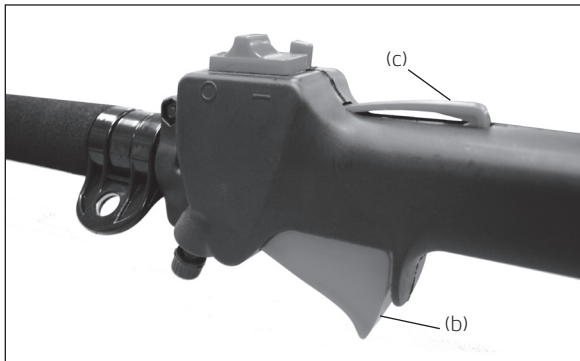

The safety lock is to prevent the throttle lever from accidentally being engaged. The throttle lever (b) can only be pressed in if the safety lock (c) is held down. Check if the safety lock and throttle lever returns to its original position and the engine returns to idling when you release your hand from the handle.

Any defects contact your nearest service agent for repairs before using the machine.

Replacing the Nylon Cord

Check to see if the nylon head is damaged before replacing the cord. If you can see serious traces of wear or damage, you must replace the complete nylon head.

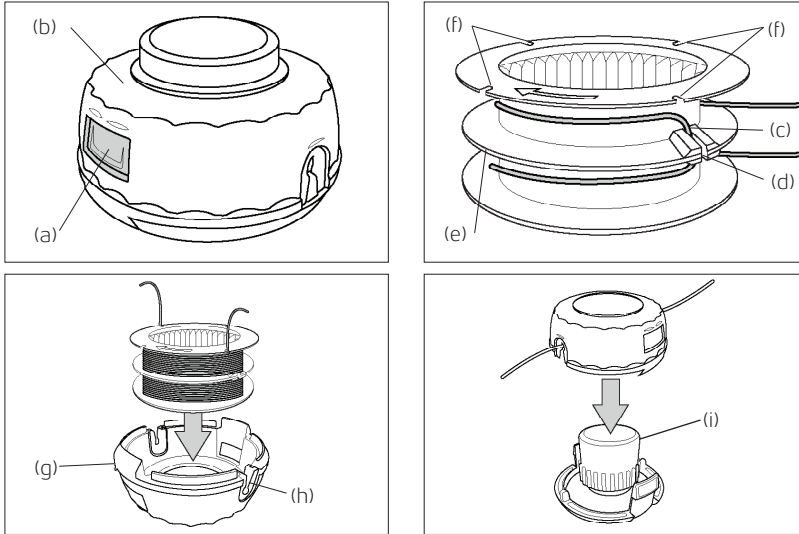

1. Stop the engine.
2. Open the nylon head by pushing on the catch, (a), and lifting the cover (b).
3. Pull the bobbin out of the nylon head and take out the rest of the nylon cords.
4. Cut a new length of cord, 2.0mm Ø and 3 meters long.
5. Fold the new cord in half and place the centre of the fold (c) into the clip (d) in the empty bobbin.
6. Wind the line in the direction of the arrows on the bobbin, with half of the line above and half below the divider (e). Maintain an even and firm tension onto the bobbin, being careful not to twist the line.
6. After winding the cord, insert both ends into the notches on the bobbin, (f).
7. Put the filled bobbin back into the carrier (g). Release the cords from the notches in the bobbin and thread them into the eyelets in the carrier (h). The cords should stick out approx 15 cm either side.
8. Refit the carrier to the head (i), ensuring it is securely clicked into place.

Never use a cutting device other than those supplied by the manufacturer. (Steel cord is never allowed) Always use original spare parts in order to benefit from continuous warranty.

Troubleshooting

Engine will not start, power loss:

- Check that the fuel tank is not empty. Fill with mixed fuel.
- The fuel does not reach the carburettor. Change the fuel filter in the fuel tank.
- There is water in the fuel. Drain and clean the fuel system.
- The air filter is dirty. Clean or replace the air filter.
- There are carbon deposits in the exhaust muffler restricting the engine. Clean or change the muffler.
- Spark plug is worn. Replace spark plug.

Service Schedule

Component	Procedure	Before use	Every 15 Hours	Every 25 Hours	Every 50 Hours	Note
Fuel leaks / spillage	Wipe up	X				
Fuel tank, filter	Inspect / clean		X			Replace if necessary
Idle adjust screw	See p.22	X		X		Adjust carburettor if necessary
Spark plug BPMR7A	Clean and readjust plug gap		X			GAP .025" (0.6-0.7mm) Replace, if necessary
Cylinder fins, Intake air cooling vent	Clean		X			
Muffler, Spark arrestor, cylinder exhaust port	Clean				X	
Throttle lever, ignition switch	Check operation	X				
Air filter	Clean	X				
Screws, nuts, bolts	Tighten / replace	X				Not adjustment screws

Specifications

Model	25C-SP Special Edition
Engine type	1E34F-4 (air cooled 2-stroke petrol engine)
Power (max.)	0.75Kw
Engine displacement	25.4cc
Idling speed	3100 ± 300
Engine maximum speed no load	Grass Trimmer 9000 rpm
Cutting diameter	Nylon Head 430mm
Cutting Line Diameter	2.0mm
Fuel	Mixture (Petrol 40: Oil 1)
Fuel tank Volumes	0.9L
Net weight (without fuel/harness)	6.3
Noise LWA dB(A)	110.4
Spark plug	BPMR7A
Carburetor	Diaphragm Type

Parts Diagram - Engine

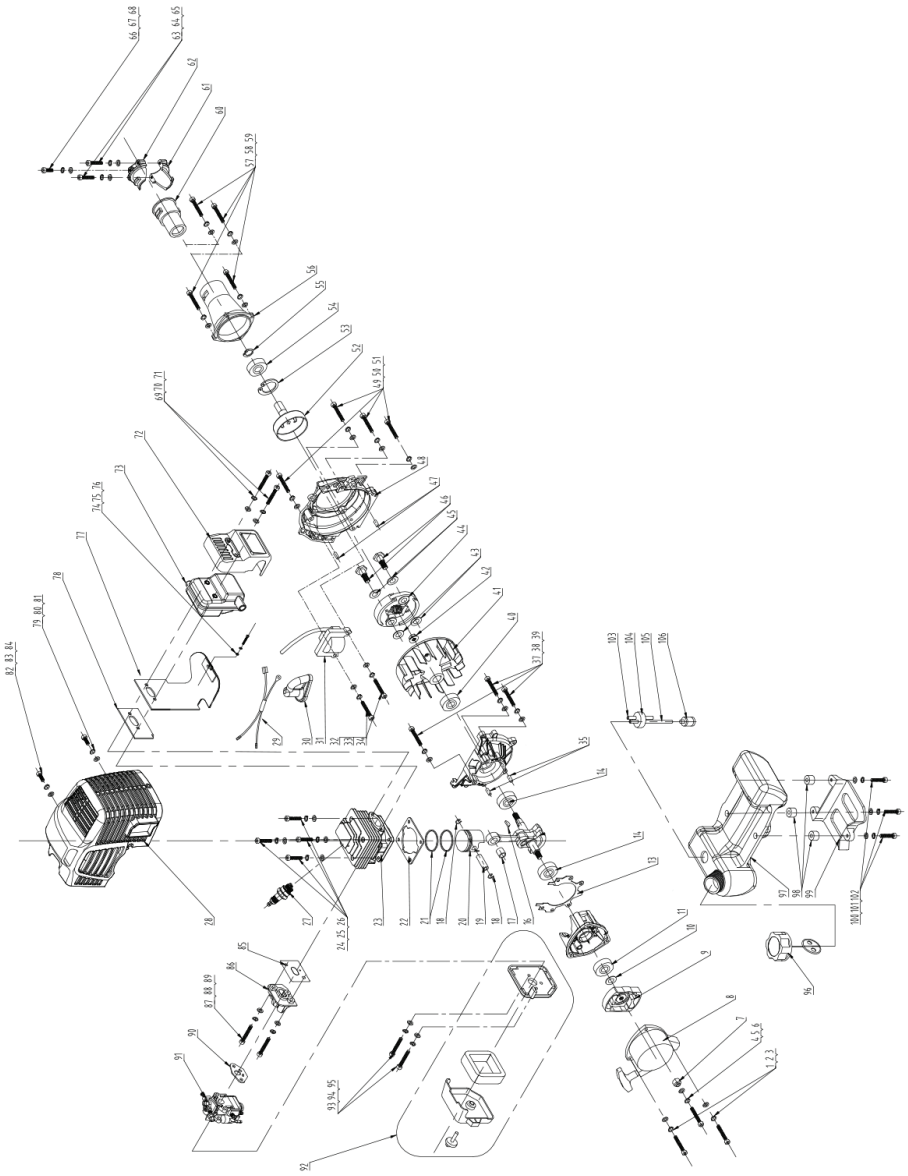

Parts List - Engine

ID No.	Part Number	DESCRIPTION
1	MIGB/T2671.2 M5X16	SCREW M5X16
2	MIGB/T93 M5	SPRING WASHER M5
3	MIGB/T97.1 M5	WASHER M5
4	MIGB/T2671.2 M5X25	SCREW M5X25
5	MIGB/T93 M5	SPRING WASHER M5
6	MIGB/T97.1 M5	WASHER M5
7	MITBC260AD.01.00.00-10	BUSHING
8	MITBC260D.01.12.00-00	RECOIL STARTER ASSY
9	MITBC260D.01.00.02-00	STARTER RATCHET ASSY
10	MIGB/T97.1 M8	FLAT WASHER M8
11	MIYD38-3.01.01.02-00	OIL SEAL 12X22X7
13	MITBC260D.01.01.00-3	GASKET - CRANKCASE
14	MIGB/T276 6001	BEARING 6001
16	MIGB/T1099 3X3.5X10	SEMI-CIRCULAR KEY 3X3.5X10
17	MITBC260D.01.03.03-00	BEARING 6001 8x11x11
18	MIYD38-3.01.03.00-4	PISTON PIN CIRCLIP
19	MIGJB25D.01.03.00-2	PISTON PIN
20	MIGJB25D.01.03.02-00	PISTON
21	MIGJB25D.01.03.00-1	PISTON RING
22	MITBC260D.01.00.00-4	GASKET - CYLINDER
23	MITBC261D.01.00.00-1	CYLINDER
24	MIGB/T2671.2 M5X20	SCREW M5X20
25	MIGB/T93 M5	SPRING WASHER M5
26	MIGB/T97.1 M5	WASHER M5
27	SPBPMR7A	SPARK PLUG (NGK BPMR7A OR EQUIV)
28	MITBC260AD.01.00.00-2	ENGINE COVER
29	MITBC260D.01.11.02-00	WIRE
30	MITBC430D.01.11.00-1	SPARK PLUG COVER
31	MITBC260D.01.11.01-00	IGNITION COIL
32	MIGB/T2671.2 M5X20	SCREW M5X20
33	MIGB/T93 M5	SPRING WASHER M5

Parts List - Engine

ID No.	Part Number	DESCRIPTION
34	MIGB/T97.1 M5	WASHER M5
35	MIGB/T119.2 5X10	PIN 5X10
37	MIGB/T2671.2 M5X30	SCREW M5X30
38	MIGB/T93 M5	SPRING WASHER M5
39	MIGB/T97.1 M5	WASHER M5
40	MIYD38-3.01.01.02-00	OIL SEAL 12X22X7
41	MITBC260D.01.10.00-00	FLYWHEEL
42	MIGB/T6177.2 M8X1	NUT M8X1
43	MIGJB25D.01.00.00-15	WAVE SPRING WASHER
44	MITBC260D.01.00.03-00	CLUTCH ASSEMBLY
45	MIGJB25D.01.00.00-15	WAVE SPRING WASHER
46	MIGJB25D.01.00.00-14	BOLT FOR CLUTCH
47	MIGB/T119.2 4X12	PIN 4X12
48	MITBC260D.01.01.00-4	FLYWHEEL COVER
49	MIGB/T2671.2 M5X20	SCREW M5X20
50	MIGB/T93 M5	SPRING WASHER M5
51	MIGB/T97.1 M5	WASHER M5
52	MITBC260D.01.14.01-00	CLUTCH DRUM ASSEMBLY
53	MIGB/T893.1 35	CIRCLIP (SIZE 35)
54	MIGB/T276 6202-2Z	BEARING 6202
55	MIGB/T894.1 15	STOP RING (SIZE 15)
56	MITBC260D.01.14.00-1	CLUTCH DRUM HOUSING
57	MIGB/T2671.2 M6X20	SCREW M6X20
58	MIGB/T93 M6	LOCK WASHER M6
59	MIGB/T97.1 M6	FLAT WASHER M6
60	MITBC430D.01.14.00-2	ANTIVIBE RUBBER
61	MITBC430D.01.14.00-4	CLAMP RH
62	MITBC430D.01.14.00-3	CLAMP LH
63	MIGB/T2671.2 M5X25	SCREW M5X25
64	MIGB/T93 M5	SPRING WASHER M5
65	MIGB/T97.1 M5	WASHER M5

Parts List - Engine

ID No.	Part Number	DESCRIPTION
66	MIGB/T2671.2 M5X12	SCREW M5X12
67	MIGB/T93 M5	SPRING WASHER M5
68	MIGB/T97.1 M5	WASHER M5
69	MIGB/T2671.2 M5X55	SCREW M5X55
70	MIGB/T93 M5	SPRING WASHER M5
71	MIGB/T97.1 M5	WASHER M5
72	MITBC226D.1-2	MUFFLER COVER
73	MITBC260D.01.09.00-00	MUFFLER
74	MIGB/T2672 M4X14	SCREW M4X14
75	MIGB/T93 M4	WASHER M4
76	MIGB/T97.1 M4	PLAIN WASHER M4
77	MITBC260AD.01.00.00-8	HEAT SHEILD
78	MITBC260AD.01.00.00-6	GASKET - MUFFLER
79	MIGB/T2671.2 M5X12	SCREW M5X12
80	MIGB/T93 M5	SPRING WASHER M5
81	MIGB/T97.1 M5	WASHER M5
82	MIGB/T2671.2 M5X12	SCREW M5X12
83	MIGB/T93 M5	SPRING WASHER M5
84	MIGB/T97.1 M5	WASHER M5
85	MITBC260D.01.00.00-5	GASKET
86	MITBC260D.01.00.01-00	MANIFOLD
87	MIGB/T2671.2 M5X20	SCREW M5X20
88	MIGB/T93 M5	SPRING WASHER M5
89	MIGB/T97.1 M5	WASHER M5
90	MIGJB25D.01.00.00-6	GASKET
91	MITBC260D.01.06.00-00	CARBURETTOR
92	MIGJB25D.01.08.00-00	AIR FILTER ASSY
93	MIGB/T2671.2 M5X50	SCREW M5X50
94	MIGB/T93 M5	SPRING WASHER M5
95	MIGB/T97.1 M5	WASHER M5
96	MITBC430D.01.13.01-00	FUEL CAP ASSY

Parts List - Engine

ID No.	Part Number	DESCRIPTION
97	MITBC260D.01.13.00-1	FUEL TANK
98	MITBC430D.01.13.00-2	AV RUBBER
99	MITBC260D.01.00.00-7	BRACKET- FUEL TANK
100	MIGB/T2671.2 M5X25	SCREW M5X25
101	MIGB/T93 M5	SPRING WASHER M5
102	MIGB/T97.1 M5	WASHER M5
103	MITBC430D.01.13.00-5	RETURN PIPE
104	MITBC430D.01.13.00-3	GROMMET
105	MITBC430D.01.13.00-4	FUEL PIPE
106	MITD38-3.03.04-00	FUEL FILTER

Parts Diagram - Shaft

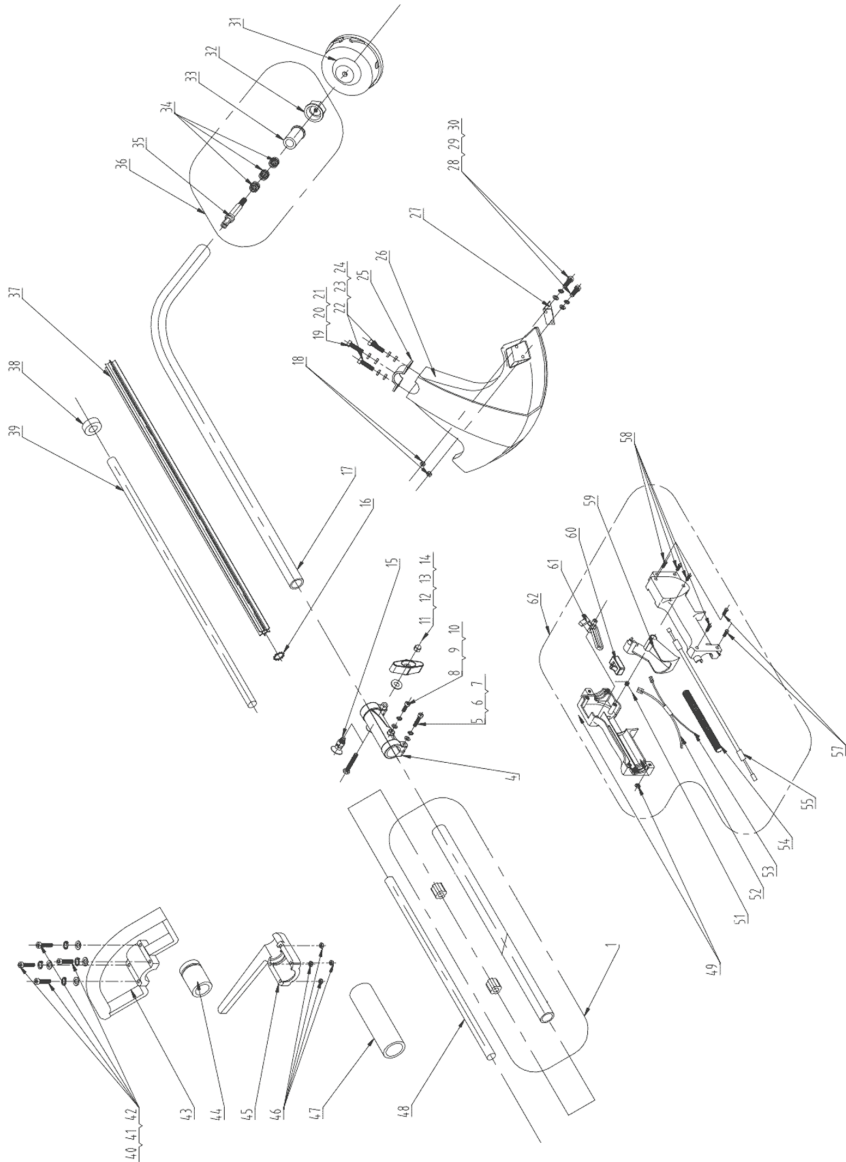

Parts List - Shaft

ID No.	Part Number	DESCRIPTION
1	MITTR260SJ.03.02-00	OUTER SHAFT - UPPER
4	MITTR261DJ.03.03-00	COUPLING
5	MIGB/T70.1 M5X25	CAP HEAD SCREW M5X25
6	MIGB/T93 M5	SPRING WASHER M5
7	MIGB/T97.1 M5	WASHER M5
8	MIGB/T70.1 M5X12	BOLT M5X12
9	MIGB/T93 M5	SPRING WASHER M5
10	MIGB/T97.1 M5	WASHER M5
11	MIGB/T5781 M6X50	BOLT M6X50
12	MIGB/T96 M6	WASHER M6
13	MITBC431DJ.03.03-7	LOCK KNOB
14	MIGB/T923 M6	NUT M6
15	MITBC431DJ.03.03-3	LOCK ASSY
16	MITTR260SJ.03.01-3	SPRING WASHER
17	MITTR260SJ.03.01-1	CURVE TUBING
18	MIGB/T6170 M5	NUT M5
19	MIGB/T70.1 M5X8	SCREW M5X8
20	MIGB/T93 M5	SPRING WASHER M5
21	MIGB/T97.1 M5	WASHER M5
22	MIGB/T70.1 M5X14	CAP HEAD SCREW M5X14
23	MIGB/T93 M5	SPRING WASHER M5
24	MIGB/T97.1 M5	WASHER M5
25	MITTR260SJ.06.00-2	GUARD CLAMP
26	MITTR260SJ.06.00-1	TRIMMER GUARD
27	MITTR260SJ.06.00-3	CUTTING BLADE
28	MIGB/T70.1 M5X14	CAP HEAD SCREW M5X14
29	MIGB/T93 M5	SPRING WASHER M5
30	MIGB/T97.1 M5	WASHER M5
31	MITTR260SJ.02.01-00	STRING HEAD ASSEMBLY
32	MITTR260SJ.03.04-3	NUT COVER
33	MITTR260SJ.03.04-1	HOUSING BEARING

Parts List - Shaft

ID No.	Part Number	DESCRIPTION
34	MITTR260SJ.03.06-00	BEARING 11X15X12.5
35	MITTR260SJ.03.04-2	OUTPUT SHAFT
36	MITTR260SJ.03.04-00	DRIVE ASSY
37	MITTR261SJ.03.00-2	LINER
38	MITTR260SJ.03.05-2	EYELET
39	MITTR261SJ.03.08-00	FLEXIBLE SHAFT
40	MIGB/T70.1 M5X30	CAP HEAD SCREW M5X30
41	MIGB/T93 M5	SPRING WASHER M5
42	MIGB/T97.1 M5	WASHER M5
43	MITBC430S.05.01-1	LOOP HANDLE - UPPER
44	MITBC430S.05.01-3	AV RUBBER
45	MITBC430S.05.01-2	LOOP HANDLE - LOWER
46	MIGB/T6170 M5	NUT M5
47	MITTR260SJ.02.00-1	FOAM GRIP
48	MITBC430DJ.03.00-1	DRIVE SHAFT - UPPER
49	MIGB/T6170 M5	NUT M5
51	MITBC430S.05.02-4	THROTTLE SPRING
52	MITBC430S.05.05-00	CABLE (A)
53	MITBC430S.05.06-00	CABLE (B)
54	MITBC430S.05.02-8	CONDUIT
55	MITBC430S.05.03-00	THROTTLE CABLE
57	MIGB/T2671.2 M5X22	SCREW M5X22
58	MIGB/T845 ST4.2X19	SCREW ST4.2X19
59	MITBC430S.05.02-3	THROTTLE TRIGGER
60	MITBC430S.05.04-00	SWITCH
61	MITBC430S.05.02-5	LOCK TRIGGER
62	MITBC430S.05.02-00	THROTTLE ASSY



CONDITIONS OF WARRANTY

The manufacturer warrants the product against faulty materials and workmanship for a period of 1 year from the date of first purchase. The warranty is applicable when the product is used in a "home owner" application. If products are used for commercial or professional purposes, the warranty period is for 3 months from the date of first purchase. Warranty does not extend to failure due to fair wear and tear.

The manufacturer undertakes to replace, any spare parts that are classified as defective by an appointed Mitox service dealer. The manufacturer will not accept liability for the replacement of the machine, either partially or wholly, and /or consequential damages and /or interest charges either directly or indirectly.

Warranty does not cover failure due to:

Insufficient maintenance.

Incorrect fuel mixture and stale fuel.

Abnormal use or accidental damage.

Incorrect assembly, adjustment or operation of the product.

Spare parts that are subject to wear e.g. safety parts, blades, blade supports, bearings, cables, guards, deflectors, spark plugs, air filters etc.

Neither does warranty extend to:

Freight and packing costs.

Use of non-genuine spare parts i.e. those from another manufacturer.

Use of the machine for any other purpose than that for which it was designed.

Use and maintenance of the machine in a manner not described in the owner's manual.

As part of our policy of continuous product improvement, we reserve the right to alter or amend this specification without notice. As a result, the product may differ from the information contained herein but any alteration will only be implemented without notice if it is classified as an improvement to the above specification.

READ THE MANUAL CAREFULLY BEFORE OPERATING THE MACHINE

When ordering spare parts, please quote the part number, this can be found in the parts list included in this manual. Retain the receipt of purchase without which no warranty can be offered.

Mitox Garden Machinery
Wincanton Business Park
Wincanton
Somerset
BA9 9RS