



## Operator's Manual

user manual, maintenance instructions and spare parts  
CS260TX PREMIUM Chainsaw



Read this manual carefully before operating the machine  
Original Instructions Version November 16

## Component Location

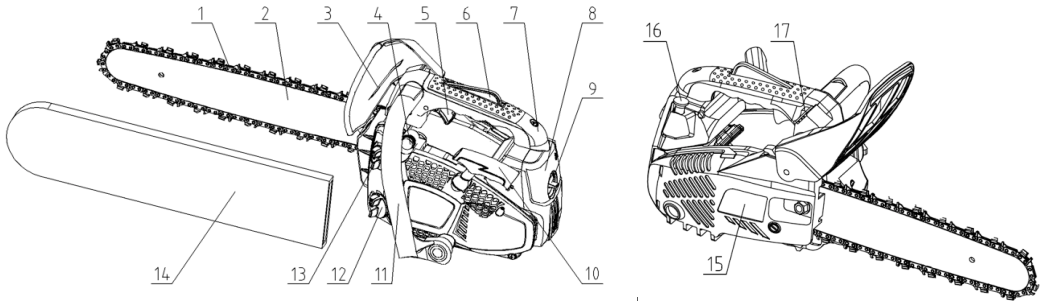

- |                                |                     |                        |
|--------------------------------|---------------------|------------------------|
| 1. Saw chain                   | 7. Rear Handle      | 13. Fuel tank          |
| 2. Guide bar                   | 8. Air Filter Cover | 14. Guide Bar Scabbard |
| 3. Front Hand Guard            | 9. Lock Nut         | 15. Clutch Cover       |
| 4. Primer Bulb                 | 10. Starter Handle  | 16. Choke Knob         |
| 5. Throttle Trigger            | 11. Front Handle    | 17. Engine Switch      |
| 6. Throttle Trigger Lock Lever | 12. Oil Tank        |                        |

## PRODUCT DESCRIPTION

This Chainsaw is a 2 stroke fast running power tool and is designed only to be used by competent operators, in a domestic application, off the ground and for cutting wood. Do not cut metal, plastic or any non-wood materials.

### **!** IMPORTANT

**This Chainsaw must be fitted with a Green Label anti-kickback chain.**

## Warnings in the Manual



This mark indicates instructions which must be followed in order to prevent accidents which could lead to serious bodily injury or death.



This mark indicates instructions which must be followed or it leads to mechanical failure, breakdown, or damage.



This mark indicates hints or useful directions in the use of the product.

## Safety Symbols

Warning: Danger, Caution	
Read the documentation and safety instructions which are provided in this user manual	
When operating this machine, use protective equipment such as goggles, helmet and ear defenders	
Use the Chainsaw with two hands	
Beware: Keep hands and feet away from moving parts. Always keep a safe distance from the cutting parts	
Beware of objects being thrown from the operating zone	
Warning! Danger of Kickback	

Directive 2000-14/CE. Guaranteed noise levels	
Danger: Risk of intoxication	
Danger: Risk of fire or explosion	
This Chainsaw is for trained tree service operators only	
Hot surface, risk of burn	

## Taking Care of Warning Labels

Always keep warning labels clean and free of scratches, which might make them illegible or difficult to read. If the warning labels provided with your Chainsaw become damaged, peel off, or otherwise become illegible or difficult to read, order new labels from the authorised servicing dealer and replace the damaged labels. When applying new labels, first wipe away any dirt and dry the surface before applying the new label in the same place as the original label.

## Explanation of Symbols on the Machine

For safe operation and maintenance, symbols are carved in relief on the machine.



**FUEL TANK**  
2 stroke mix  
Position: Fuel cap



**CHAIN OIL TANK**  
Position: oil cap



**STOP SWITCH**  
Setting the switch to the "0" position, the engine stops immediately.  
Position: Front-right of the unit



**CHOKE OPERATION**  
**<RUN>**

Starting mode when the engine is hot.  
Position: Upper-right of the air cleaner cover



**<START>**

Starting mode when the engine is cold.  
Position: Upper-right of the air cleaner cover



**HIGH-SPEED ADJUSTMENT SCREW**

Position: Left side, screw under "H" stamp



**SLOW-SPEED ADJUSTMENT SCREW**

Position: Left side, screw under "L" stamp



**IDLE ADJUSTMENT SCREW**

Position: Left side, screw under "T" stamp

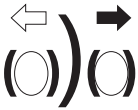

**CHAIN BRAKE RELEASE / ACTIVATION**

Released (white arrow) and Activated (black arrow).  
Position: Front of the front handle

This Chainsaw is equipped with extremely sharp blades, always wear sturdy gloves when handling the blades and fit the safety guards when not in use.

When using this Chainsaw for the first time, take it to a wide, clear, open space, start the engine, and practice handling the Chainsaw until you are sure that you will be able to handle it properly in actual operation.

You should never use this Chainsaw when under the influence of alcohol, suffering from exhaustion or lack of sleep, suffering from drowsiness as a result of having taken medicine, or at any other time when your judgement might be impaired or that you might not be able to operate the Chainsaw properly and in a safe manner.

Never allow children or anyone unable to fully understand the directions given in this manual to use this Chainsaw.

When planning your work schedule, allow plenty of time to perform the work and allow plenty of time for rest. Limit the amount of time you continuously use this product to 30-40 minutes per session and take 10-20 minutes of rest between work sessions. Also, try to keep the total amount of work performed in a single day to 2 hours.

Never run the engine indoors as the exhaust gases contain harmful carbon monoxide.

## **Never use this Chainsaw in the conditions described below:**

When conditions exist which might make it difficult to maintain a steady posture while using this product.

At night, at times of heavy fog, or at any other time when your field of vision is limited and it would be difficult to gain a clear view of the area where it is to be used. In heavy rain, during lightning storms, at times of strong or gale-force winds or at any other time when the weather conditions might make it unsafe to use this product.

## Work Clothing & Safety Equipment

When using this product, you should wear the correct Personal Protective Equipment.

- Helmet
- Safety goggles / face protector
- Ear protection
- Thick work gloves
- Non-slip, steel toe capped work boots
- Strong, durable work clothing; shirts should be long sleeved and trousers should be chainsaw trousers with all round protection.

## Safety and Operation



**Improper handling can cause accidents which may in turn lead to serious injury or death. Always adhere to the following instructions when using this product:**

- Never hold this product with the cutting head pointing towards someone else.
- Never allow the blade/blades to come into contact with your body.
- Always turn off the engine before making adjustments or when coming close to the cutting head.

## Before Starting Work

Carefully check the work area and remove any obstacles. A perimeter of 15 metres of the work area should be considered a hazardous area, into which no-one should enter while this product is being used. When necessary this area should be marked with a warning rope, warning signs or other forms of warning.

If work is to be carried out by two or more operators, care should be taken to constantly check the location of other operators within the work area, to maintain a safe distance between each operator.

Before starting work all components of this product should be checked to make sure that it is in proper working order. Ensure there are no loose screws or bolts, fuel leaks, ruptures, dents, broken guards or any other problems which might affect the safe operation.

Keep all parts of your body away from the cutting head when the engine is running.

## Before Starting the Engine

Place your machine on the ground in a flat, clear area and hold it firmly to ensure that neither the cutting head or throttle come into contact with any obstacles when the engine starts.

## After Starting the Engine

Ensure the cutting head stops moving when the throttle trigger is released (idle). If the cutting head continues to move when the engine is at idle, adjust the idle screw on the carburettor to a point where the cutting head stops moving. If this cannot be achieved, take your machine to your authorised MITOX® dealer for adjustment.

## Avoid Noise Problems



Check and follow the local regulations for sound levels and hours of operation for garden machinery. In general, operate garden machinery between 8am and 5pm weekdays and 9am and 5pm weekends. Avoid using garden machinery early in the morning and/or late at night.

## Safety During Operation



When using your Chainsaw, grip the handles firmly with both hands place your feet slightly apart so your weight is distributed evenly across both legs and always be sure to maintain a steady even posture while working. Do not use on ladders or if the ground surface is slippery or uneven. Never attempt to cut overhead.



- Maintain full engine speed when cutting.
- Never allow other persons to come within the work area as doing so might expose them to danger.
- If a branch or other object gets caught in the blades during operation, always turn off the engine before removing the object.
- To protect yourself against injury from falling branches, wear the required safety equipment.
- Keep the operation area clear of all persons, particularly small children and pets. Injury may result from flying debris.
- Never touch the spark plug or plug HT cable while the engine is in operation, doing so may result in an electrical shock.
- Never touch the exhaust, spark plug or any metallic parts of the engine while the engine is in operation or immediately after shutting down the engine. These parts reach high temperatures during operation and doing so could result in serious burns.
- When you finish cutting in one location and wish to continue work in another area, turn off the engine, place the protective cover over the blades, and turn the chain saw so that the blades face away from your body before carrying it to the new location.
- Always remove fuel from the fuel tank before transportation to prevent fuel spillage.
- When not in use never leave the chain saw exposed to direct sunlight as this can heat the fuel tank and may cause a discharge of fuel, and flood the engine.



## In the Box

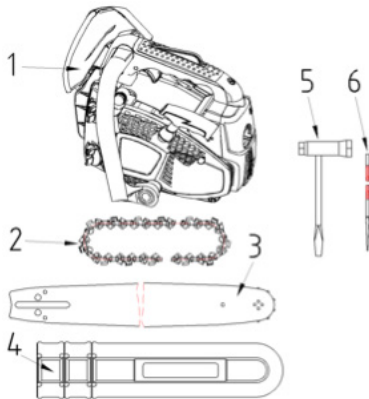

**A standard saw unit package contains the items as illustrated**

- 1) Power unit
- 2) Saw chain
- 3) Guide bar
- 4) Bar protector
- 5) Plug wrench
- 6) File

### Not pictured

- 7) Spike and mounting screws, dependent on model
- 8) Owner's manual

## Safe Handling of Fuel



The engine of the Chainsaw is designed to run on a two stroke oil/fuel mixture.

This fuel is highly flammable; never store cans of fuel or refill the fuel tank in any place where there is a source of heat or fire, which might ignite the fuel.

Do not smoke whilst operating or refilling the Chainsaw, keep lit cigarettes away from the Chainsaw at all times.

When refilling the fuel tank always stop the engine first and carefully make sure that there are no sparks or naked flames anywhere nearby before refuelling.

If any fuel spillage occurs during refuelling, use a dry rag to wipe any fuel which has been spilled onto the Chainsaw before starting the engine.

After refuelling, screw the fuel cap back tightly onto the fuel tank and carry the Chainsaw to a spot 5 metres or more away from where it was refuelled before starting the engine.

## Two-Stroke Fuel



Fuel is very flammable. Do not smoke or bring any flame or sparks near fuel.

The engine is lubricated by oil mixed into petrol. Prepare a mixture of unleaded petrol and semi-synthetic two-stroke oil that meets the specifications of: API TC, ISO-L-EGC, JASO FC (Low Smoke) oil.

**Recommended mixing ratio is 40:1.**

**FUEL WITH NO OIL (RAW PETROL) will cause severe damage to the engine which is not covered by the manufacturer's warranty.**

Use fresh, unleaded petrol (95 RON) and semi-synthetic oil specially made for high performance two-stroke engines. Mix in a ratio of 40 parts petrol to 1 part of oil.

By using two-stroke oil specially made for two-stroke engines you will reduce the formation of ash and carbon deposits on the spark plug, piston, exhaust muffler and cylinder as well as reducing emissions of harmful exhaust gases.

Oil FOR 4-CYCLE ENGINES should not be used as two-stroke lubrication oil as it can cause fouling of the spark plug, exhaust port blocking, piston ring sticking and other internal engine damage.

 **NOTE**

Due to increased Ethanol content in petrol we recommend the use of B3C Ethanol Shield 2-Stroke Oil, or Ethanol Shield Fuel Stabiliser to protect your MITOX® engine against the harmful effects of Ethanol.

Visit [www.b3cfuel.co.uk](http://www.b3cfuel.co.uk) for more information.



 **IMPORTANT**

## Fuel Storage (Without Ethanol Shield)

Mixed two-stroke fuel which has been left unused for a period of one month or more may damage the carburettor and result in the engine failing to start or operate correctly.

When storing the Chainsaw for a period of more than one month, empty the fuel tank and run the engine to empty the carburettor of fuel.

Two-stroke fuel can cause deterioration of rubber and/or plastic components during prolonged storage.

**It is important to only use good quality, fresh fuel.**

## Fuelling

Shake the fuel container to thoroughly mix the two-stroke oil and petrol.

Clean dirt from around the fuel cap before removing.

Pour two-stroke fuel into the fuel tank with a filtered funnel, up to 80% of the fuel tank's capacity.

Replace the fuel cap and tighten securely. Spilled fuel must be wiped away from the Chainsaw before starting the engine.

Move at least 5m away from the refuelling area before restarting the engine.



When refilling the tank, always turn off the engine and allow it to cool down. Take a careful look around to make sure that there are no sparks or open flames anywhere nearby before refuelling.

## Chain Oil

Use only specialist anti fling chain oil. Fill the chain oil tank every time you fill the fuel tank.



**Do not use waste or regenerated oil that can cause damage to the oil pump.**

## Installing the Guide Bar and Chain

Open the box and install the guide bar and the saw chain on the power unit as follows:  
The saw chain has very sharp edges. Use thick protective gloves for safety.

1. Pull the chain brake towards the front handle to check that the chain brake is not on.
2. Loosen the nut (1) and remove the chain cover (2) (Figure 1).
3. Install the spike (3) to the power unit using the 2 tapping screws (4) (Figure 1).
4. Remove and discard the plastic packer (1) located on the bar studs (Figure 2).

Figure 1.

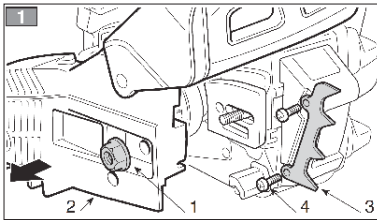
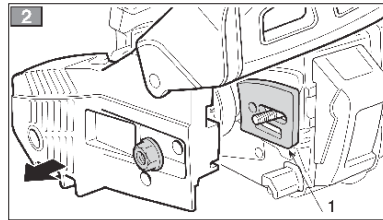

Figure 2.



5. Fit the guide bar (2) over the bar bolts (Figure 3).
6. Fit the chain to the drive sprocket (Figure 4) and around the guide bar.

Figure 3.

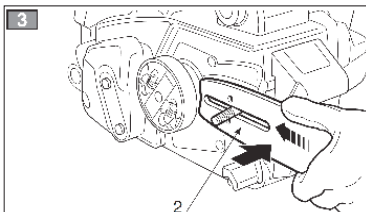
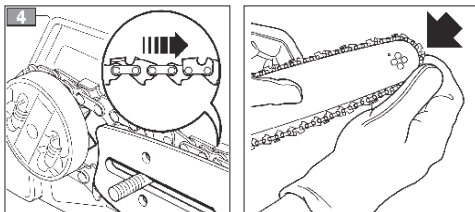

Figure 4.



8. Adjust the position of the tensioner nail (3) on the chain cover and insert into the lower hole of the guide bar. Fasten the chain cover nut (fig 1.1) finger tight and while holding up the tip of the bar, adjust the chain tension by turning the tensioner screw (4) until the chain does not sag from the underside of the guide bar (Figure 5).
9. Tighten the bar nuts securely with the bar held up to 12/15N.M, then check the chain for smooth rotation and proper tension while moving the chain by hand (Figure 6).

Figure 5.

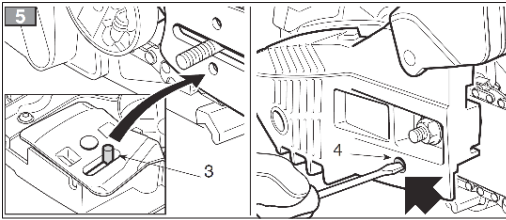
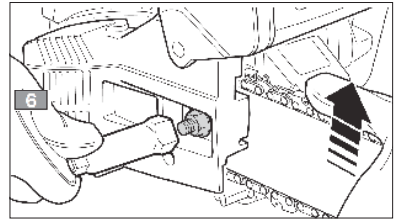

Figure 6.

**NOTE**

**A new chain will expand in length at the beginning of use. Check and readjust the tension frequently, as a loose chain can easily derail or cause rapid wear to itself and the guide bar.**

10. Check the tension of the saw chain - Use your gloved hand to lift the chain link positioned in the centre of the guide bar, using approx 10N force. If the chain link can be moved outside of the rail of the guide bar, the chain requires further tightening (Figure 7).

Figure 7.

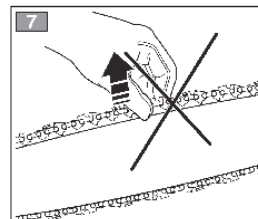

## Chain Brake

This machine is equipped with an automatic brake to stop the saw chain rotation upon the occurrence of kickback during saw cutting. The brake is automatically operated by inertial force, which acts on the weight fitted inside the front guard.

The brake can also be operated manually by pushing the chain brake forward towards the guide bar. To release the brake, pull back the chain brake (4) toward the rear handle (1) until a “click” sound is heard (2).

### How to check:

You must check the chain brake operation before each usage by running the saw at full throttle for 1-2 seconds and pushing the front hand guard (4) forward (3).

The chain should stop immediately with the engine at full speed.

If the chain is slow to stop or does not stop, replace the brake band and clutch drum before use.

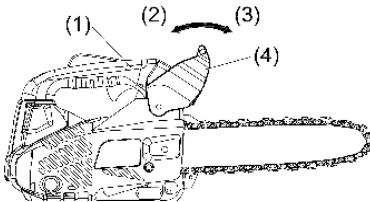

- (1) Rear handle
- (2) Release
- (3) Brake
- (4) Front handle guard

### Always follow the safety regulations:

The chainsaw must only be used for cutting wood. It is forbidden to cut other types of material. Vibrations and kick-back vary with different materials and the requirements of the safety regulations would not be met. Do not use the chainsaw as a lever for lifting, moving or splitting objects. The saw should cut easily without force. Apply only light pressure while running the engine at full throttle.

When the saw chain is caught in the cut, do not attempt to pull it out by force, but use a wedge or a lever to sufficiently open the gap in the wood.



## Kickback Safety Precautions

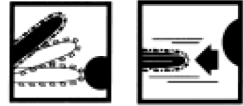

Kickback may occur when the nose or tip of the guide bar touches an object, or when the wood closes in and pinches the saw chain in the cut. Top contact in some cases may cause a lightning fast reverse reaction, kicking the guide bar up and back towards the operator. Pinching the saw chain along the top of the guide bar may push the guide bar rapidly back towards the operator. Either of these reactions may cause you to lose control of the saw which could result in serious personal injury.

Do not rely exclusively on the safety devices built into your saw. As a chain saw user you should take several steps to keep cutting jobs free from accident or injury.

1. With a basic understanding of kickback you can reduce or eliminate the element of surprise. Sudden surprise contributes to accidents.
2. Keep a good grip on the saw with both hands, the right hand on the rear handle, and the left hand on the front handle, when the engine is running. Use a firm grip with thumbs and fingers encircling the chainsaw handles. A firm grip will help you reduce kickback and maintain control of the saw.
3. Make certain that the area in which you are cutting is free from obstructions. Do not let the nose of the guide bar contact a log, branch, or any other obstruction which could be hit while you are operating the saw.
4. Cut at high engine speeds.
5. Do not overreach or cut above shoulder height.
6. Follow the manufacturer's sharpening and maintenance instructions for saw chain.
7. Only use replacement bars and chains specified by the manufacturer.

**It is important to maintain the proper chain tension. Rapid wear of the guide bar or the chain coming off can be caused by improper tension, especially when using a new chain.**

## Operating the Engine

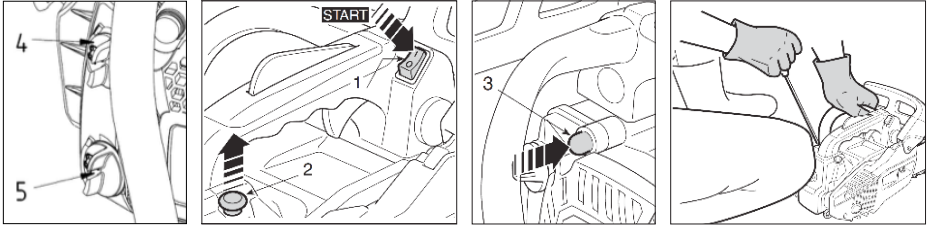

1. Fill fuel (4) and chain oil (5) tanks respectively, and tighten the caps securely.
2. Set the switch (1) to "I" position.
3. Press the primer button (3) 6 times.
4. Pull out the choke knob (2). The choke will close and the throttle will be set in the starting position.
5. Apply the chain brake by pushing the chain brake forwards.
6. Place the saw on the ground, grip the front handle with your left hand. Pull the starter handle with your right hand. **Caution: Do not pull the starter cord all the way out and do not let go of the starter handle if the cord is extended, this can damage the mechanism.**
7. When the engine has tried to fire, push in the choke knob (5) and then pull the starter handle again to start the engine.
8. As soon as the engine is running, pull the throttle lever slightly to reset the throttle control to idle. This must be done as soon as the engine has started to avoid unnecessary wear on the clutch.

**NOTE: Disengage the chain brake by pulling the chain brake towards the front handle prior to cutting.**

## Hot Engine Start

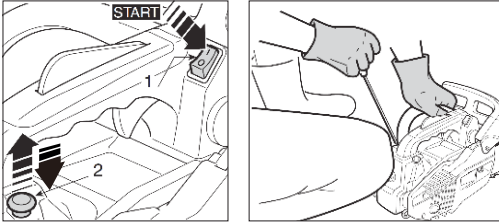

1. Set the switch (1) to "I" position.
2. Pull out the choke knob (2), then push the choke knob back in, this will set the choke to the hot start position.
3. Apply the chain brake by pushing the chain brake forwards.
4. Pull the starter handle until the engine runs.
5. Pulling the throttle lever slightly will reset the throttle control.

**Disengage the chain brake by pulling the chain brake towards the front handle prior to cutting.**

## Running In

During the first ten hours of work, avoid running the engine at maximum speed for a prolonged period until all the components have bedded in. After the engine has been run in, it will reach its maximum power. After two hours of work, check that all nuts and screws are securely fastened and tighten if necessary.

## Stopping the Engine

1. Release the throttle lever and allow the engine to run at idle for half a minute.
2. Set the ignition switch to the STOP position ("0"). **Except for an emergency, avoid stopping the engine while at full throttle.**

## Checking the Oil Supply

After starting the engine, run the chain at medium speed and see if chain oil is sprayed as shown in the figure below (1).

The chain oil flow can be changed by inserting a screwdriver in the hole on the bottom of the clutch side. Turn the shaft counter-clockwise to increase the oil flow. Turn the shaft clockwise to decrease the oil flow. Adjust according to your work conditions

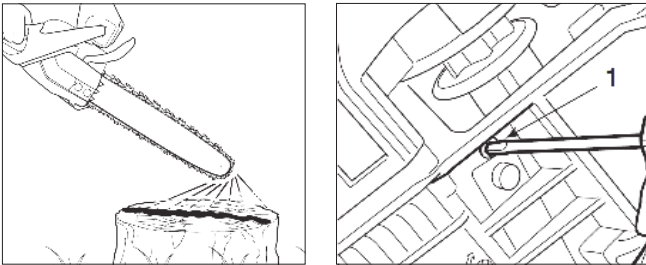

## Care and Maintenance of Your Chainsaw

- In order to maintain your chainsaw in good working order, perform the maintenance and checking operations described in this manual at regular intervals. In the event that any part needs to be replaced, please contact the nearest authorised service dealer for assistance.
- Always turn off the engine before performing any maintenance or checking procedures.
- When sharpening, removing, or reattaching the chain, be sure to wear thick, sturdy gloves and use only appropriate tools and equipment to prevent injury.
- When replacing the chain or any other parts, be sure to use only genuine spare parts and approved lubricants.

## Maintenance

**! IMPORTANT**

- After every use, check that all nuts, bolts and screws are securely fastened and tighten if necessary.
- In the event of an accident, breakdown or blockage, ensure the engine is turned off before any work is carried out to rectify this.
- Make sure the engine has stopped and is cool before performing any service to the machine. Contact with moving cutting head or hot muffler may result in a personal injury. Always wear heavy-duty gloves when handling the blades.

## Maintenance After Each Use

### Air filter

Dust on the air cleaner surface can be removed by tapping a corner of the cleaner against a hard surface. To clean dirt in the meshes, split the cleaner into halves and brush off the dust lightly or wash in non-flammable solvent, or replace the air filter. To assemble the cleaner halves, press until it clicks.

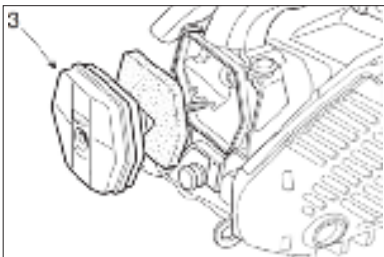

## Maintenance After Each Use

### Oiling port

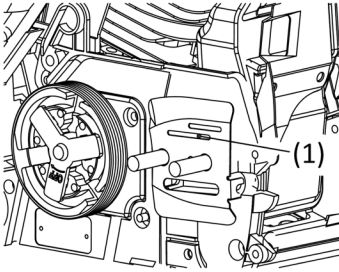

Dismount the guide bar and check the oiling port (1) for clogging.

### Guide bar

When the guide bar is dismounted, remove sawdust from the bar groove and the oiling port. Grease the nose sprocket with a sprocket grease gun (Oregon part number 21939)

1. Guide bar groove
2. Oil hole
3. Drive sprocket
4. Grease point

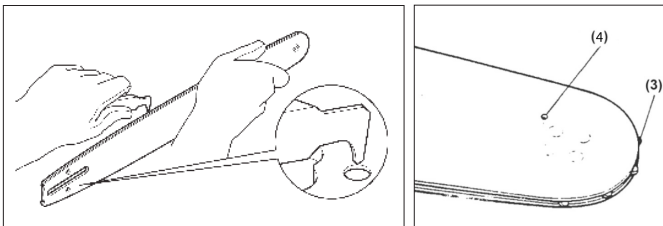

### Other Checks

Check for fuel leakage and loose fastenings and damage to major parts, especially handle joints and guide bar mounting. If any defects are found, make sure to have them repaired before operating the saw again. Check for cracks and for excessive wear interfering with the chain drive. If the wear is considerable, replace it with a new one. Never fit a new chain on a worn sprocket, or a worn chain on a new sprocket.

## Periodical Service Points

### Cylinder Fins

Dust clogging between the cylinder fins will cause overheating of the engine.

Periodically check and clean the cylinder fins after removing the cylinder cover.

When installing the cylinder cover, make sure the switch wires and grommets are fitted correctly.

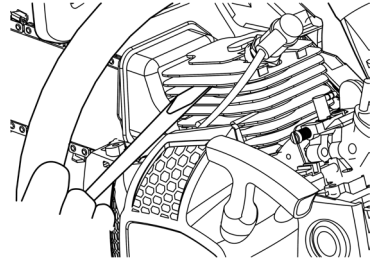

### Fuel filter

Using a wire hook, take out the filter (1) from the filler port.

Disassemble the filter and clean with petrol, or replace with a new one if needed.

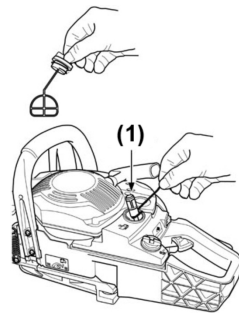

### Spark plug

Clean the electrodes with a wire brush and reset the gap to 0.65 mm as necessary.

Plug type: Champion

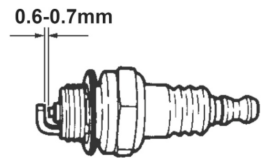

### Sprocket

Check for cracks and for excessive wear interfering with the chain drive. If the wear is considerable, replace it with a new one. Never fit a new chain on a worn sprocket, or a worn chain on a new sprocket.

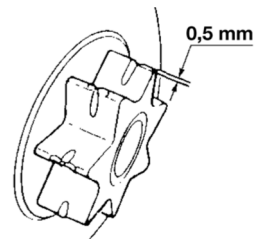

## Adjusting Oil Flow Rate

**Never fill the oil reservoir or adjust the oiler with the engine running.**

An increase in bar oil flow rate will speed oil consumption, requiring more frequent checks on the oil reservoir. To ensure sufficient lubrication, it may be necessary to check the oil level more frequently than at fuel tank refills. The guide bar and chain are lubricated automatically by a pump that operates whenever the chain rotates. The pump is set at the factory to deliver a minimum flow rate, but it can be adjusted in the field. A temporary increase in oil flow is often desirable when cutting hardwood.

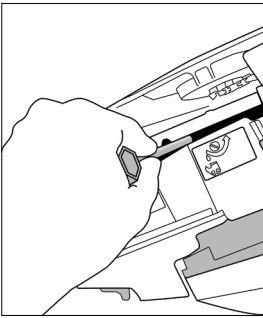

### Adjust the pump as follows:

1. Stop the engine and make sure the stop switch is in the OFF position.
2. Place the unit on its side with the sprocket side and chain brake assembly facing up.
3. With a screwdriver, push in on the oil flow rate adjusting screw and turn in the desired direction: Clockwise-decrease lubrication / Counter clockwise-increase lubrication.



## Saw Chain Sharpening

**The chain needs to be sharpened when:**

- |  |   |
|--|---|
| <ol style="list-style-type: none"> <li>1. Sawdust becomes powder-like.</li> <li>2. The cut path does not go straight.</li> <li>3. Fuel consumption increases.</li> </ol> | <ol style="list-style-type: none"> <li>4. You need extra force to saw with.</li> <li>5. Vibration increases.</li> </ol> |
|--|---|

**Be sure to wear safety gloves.**

- Clamp chain saw guide bar in a vice to secure.
- Sharpen chain with a 5/32 (4mm) file and holder (Oregon part number 16265) / Sharpening kit (Oregon part no 90405)
- Place your file on the cutter and push straight forward. Keep the file position.
- After every cutter has been set, check the depth gauge and file it to the proper level.
- Make sure every cutter has the same length and edge angles as illustrated.

	File diameter	Top plate angle	Down angle	Depth gauge standard
Type of chain	 4 mm			
91P	5/32"	30°	91P	0.025"
Depth gauge			File	

## Adjusting the Carburettor

The carburettor has been factory adjusted, but may require fine tuning due to a change in operating conditions. Before adjusting the carburettor, make sure that the provided air/fuel filters are clean and the fuel properly mixed.

When adjusting, take the following steps:

Stop the engine and screw in both the H and L needles until they stop. Never force them. Then set them back the initial number of turns as shown below.

**H needle: 2 + or -1/4**

**L needle: 2 + or -1/4**

1. Start the engine and allow it to warm up at half-throttle.
2. Turn the L needle (2) slowly to find a position where idling speed is at maximum, then set the needle back a quarter (1/4) turn counter clockwise.
3. Turn the idle adjusting screw T (1) counter clockwise so that the saw chain does not turn. If the idling speed is too slow, turn the screw clockwise.
4. To verify the low speed you should be able to pull the throttle in all the way and the engine should not die, if it tries to die, open the L jet (2) slightly and re-adjust idle if necessary.

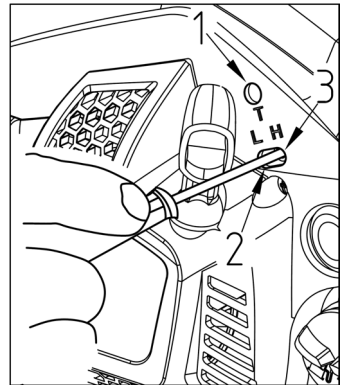

5. Set the engine to full throttle, the H jet (3) is turned clockwise to reduce fuel, as the fuel mixture is leaned out, the saw will run faster until it sounds as if it is screaming, at this point, turn the high speed screw counter clockwise by quarter (1/4) turn to allow more fuel in.

A 2-cycle engine relies on the fuel mixture to cool the engine; a lean engine will run fast but can overheat and may cause severe damage to the engine. It is recommended carburettor adjustments are carried out by authorised Mitox dealers only.

## **Working with tree service chain-saws from rope and harness**

### **1. Overview**

This chapter sets out working practices aimed at reducing the risk of injury from tree service chain-saws when working at height from a rope and harness. While it may form the basis of guidance and training literature, it should not be regarded as a substitute for formal training. The guidance given in this annex is only an example of best working practice. National laws and regulations should always be followed.

It presents

- General requirements that should be met before using a tree service chain-saw for work at height from a rope and harness,
- Preparations for using a tree service chain-saw from a rope and harness, and
- Use of a tree service chain-saw for pruning and dismantling, including secure work positioning for two-handed use, starting the chain-saw, cutting with the chain-saw, restrictions on one-handed use and freeing a trapped saw.

### **2. General requirements**

Operators of tree service chain-saws working at height from a rope and harness should never work alone. A ground worker trained in appropriate emergency procedures should assist them.

Operators of tree service chain-saws for this work should be trained in general safe climbing and work positioning techniques and be properly equipped with harnesses, ropes, strops, carabiners and other equipment for maintaining secure and safe working positions for both themselves and the saw.

### **3. Preparing to use the saw in the tree**

The chain-saw should be checked, fuelled, started and warmed up by the ground worker and then switched off before it is sent up to the operator in the tree.

The chain-saw should be fitted with a suitable strop for attachment to the operator's harness (see Figure B. 1):

- a) Secure the strop around the attachment point on the rear of the saw;
- b) Provide suitable carabiners to allow indirect (i.e. via the strop) and direct attachment (i.e. at the attachment point on the saw) of the saw to the operator's harness;
- c) Ensure the saw is securely attached when it is being sent up to the operator;
- d) Ensure the saw is secured to the harness before it is disconnected from the means of ascent.



**Figure B.1 — Example of attachment of tree service chain-saw to operator's harness**

The ability to directly attach the saw to the harness reduces the risk of damage to equipment when moving around the tree. Always switch the saw off when it is directly attached to the harness.

The saw should only be attached to the recommended attachment points on the harness. These may be at mid-point (front or rear) or at the sides. Where possible, attach the saw to the centre rear mid-point to keep it clear of climbing lines and to support its weight centrally down the operator's spine. See Figure B.2.

When moving the saw from any one attachment point to another, operators should ensure it is secured in the new position before releasing it from the previous attachment point.



**Figure B.2 — Example of attachment of tree service chain-saw to centre rear mid-point on harness**

#### 4. Using the chain-saw in the tree

An analysis of accidents with these saws during tree service operations shows the primary cause as being inappropriate one-handed use of the saw. In the vast majority of accidents, operators fail to adopt a secure work position that allows them to hold both handles of the saw. This results in an increased risk of injury due to

- Not having a firm grip on the saw if it kicks back,
- A lack of control of the saw, such that it is more likely to come into contact with climbing lines and the operator's body (particularly the left hand and arm), and
- Loss of control owing to an insecure work position and resulting in contact with the saw (unexpected movement during operation of the saw).

### Securing the work position for two-handed use

In order to allow the saw to be held with both hands, as a general rule operators should aim for a secure work position in which they operate the saw at

- Hip level, when cutting horizontal sections, and
- Solar plexus level, when cutting vertical sections.

Where the operator is working close into vertical stems with low lateral forces on the work position, then a good footing could be all that is needed to maintain a secure work position. However, as operators move away from the stem, they will need to take steps to remove or counteract the increasing lateral forces by, for example, a redirect of the main line via a supplementary anchor point or use of an adjustable strop direct from the harness to a supplementary anchor point (see Figure B.3).

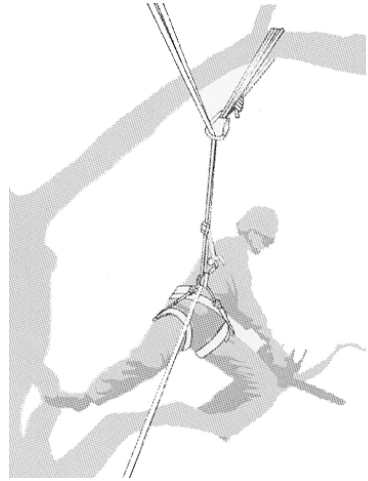

**Figure B.3 — Example of redirection of main line via supplementary anchor point**

Gaining a good footing at the working position can be assisted by the use of a temporary foot stirrup created from an endless sling (see Figure B.4).

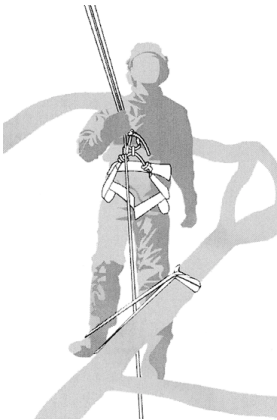

**Figure B.4 — Example of temporary foot stirrup created from endless sling**

### Starting the saw in the tree

When starting the saw in the tree, the operator should

- a) apply the chain brake before starting,
- b) hold the saw on either the left or right of the body when starting,
  - 1) on the left side, hold the saw with the left hand on the front handle and thrust the saw away from the body while holding the pull starter cord in the right hand, or
  - 2) on the right side, hold the saw with the right hand on either handle and thrust the saw away from the body while holding the pull starter cord in the left hand.

The chain brake should always be engaged before lowering a running saw onto its strop. Operators should always check that the saw has sufficient fuel before undertaking critical cuts.

### One-handed use of the chain-saw

Operators should not use tree service chain-saws one-handed when the work position is unstable or in preference to a handsaw when cutting small diameter wood at the branch tips.

Tree service chain-saws should only be used one-handed where

- operators cannot gain a work position enabling two-handed use, and
- they need to support their working position with one hand, and
- the saw is being used at full stretch, at right angles to and out of line with the operator's body (see Figure B.5).



**Figure B.5 — Example of one-handed chain-saw use**

Operators should never

- cut with the kickback zone at the tip of the chain-saw guide bar,
- “hold and cut” sections, or
- attempt to catch falling sections.

### Freeing a trapped saw

If the saw becomes trapped during cutting, operators should

- switch off the saw and attach it securely to the tree inboard (i.e. towards the trunk side) of the cut or to a separate tool line,
- pull the saw from the kerf whilst lifting the branch as necessary,
- if necessary, use a handsaw or second chain saw to release the trapped saw by cutting a minimum of 30 cm away from the trapped saw.

Whether a handsaw or a chain-saw is used to free a trapped saw, the release cuts should always be outboard (toward the tips of the branch), in order to prevent the saw being taken with the section and further complicating the situation.

## Service Schedule

Component	Procedure	Before Use	Every 25 Hours	Every 50 Hours	Every 100 Hours	Note
Fuel Leaks / Fuel Spillage	Wipe Out	•				
Fuel Tank / Fuel Filter	Inspect / Clean	•	•			Replace if Neccessary
Idle Adjusting Screw	See Adjusting Carburettor	•				Adjust if Neccessary
Spark Plug	Clean and Readjust Plug Gap			•		Gap 0.025in (0.6-0.7mm) Replace if Neccessary
Cylinder Fins / Intake Air Cooling Vent	Clean		•			
Muffler / Spark Arrestor / Cylinder Exhaust Port	Clean			•		
Throttle Lever / Ignition Switch	Check Operation	•				
Air Filter	Clean	•				
Screws / Nuts / Bolts	Tighten / Replace	•			•	Except Adjusting Screws
Oiling Port	Clean	•				
Guide Bar	Clean	•				
Sprocket	Inspect / Replace			•		
Saw Chain	Inspect / Sharpen	•				

## Troubleshooting: Power loss or engine stopping.

- Check that the fuel tank is not empty.
- The mixture does not reach the carburettor. Change the fuel filter in the fuel tank.
- There is water in the mixture. Drain then clean the fuel system .
- The air filter is dirty. Clean the air filter.
- There are carbon deposits in the cylinder exhaust pipe or muffler. Clean or change muffler.
- Spark plug is worn. Replace spark plug.

## Specifications

### Power unit

Displacement .....25.4cc

Maximum engine power.....0.9kW

Fuel.....Mixture (Unleaded Petrol 40 : two-stroke oil 1)

Fuel tank capacity.....200ml

Chain oil.....Anti-fling Chain Oil

Oil tank capacity.....140ml

Carburettor..... Diaphragm type

Fuel consumption at maximum engine power.....560g/kw-h

Idling speed.....3100r/min

Maximum speed with cutting attachment.....11000r/min

Maximum chain speed.....21m/s

Ignition system.....C.D.I. with timing advance function

Spark plug..... Champion RCJ6Y

Oil feeding system.....Mechanical plunger pump with adjuster

Sprocket Teeth x Pitch.....6Tx0.375in

Dimensions (L x W x H).....270x220x215(mm)

Dry weight (without guide bar and chain, empty tanks): .....3.2kg

Sound pressure level at operation position (EN ISO 22868): .....87.3dB(A)

Uncertainty of stated value (2006/42EC): .....3 dB(A)

Sound power level (EN ISO 22868): .....104.5dB(A)

Uncertainty of stated value (2006/42EC): .....3 dB(A)

Vibration Value (EN ISO 22867):

Front handle.....5.8m/s<sup>2</sup>

Rear handle.....12.1m/s<sup>2</sup>

Uncertainty of stated value (2006/42EC): .....1.5 m/s<sup>2</sup>



## Specifications

### Cutting gear

Guide Bar Type.....Sprocket nose

Size .....10" / 12"

Cutting length.....220mm (10") / 270mm (12")

### Saw chain

Type.....Oregon 91P

Pitch.....0.375in

Gauge.....0.050in



**PARTS LIST**

ID No.	PART NUMBER	DESCRIPTION	QTY	ID No.	PART NUMBER	DESCRIPTION	QTY
1	M1YD25.01.00.00-00	SHORT MOTOR	1	41	MIA25.0100.0006	PLUG	1
2	MIA25.0102.0000	CRANKCASE	1	42	MIA38.0306.0500	SWITCH - ON/OFF	1
4	MIGB/T276 6001	BEARING 6001D - 12X28X8	2	43	MIA25.0600.0100	COVER - REAR HANDLE	1
5	MIA25.0103.0300	OIL SEAL - 12X28X6	1	44	MIA25.0100.0016	BOLT	4
6	MIA25.0103.0003	SEAL - NEEDLE BEARING	2	45	MIA25.0100.0020	CAP	3
7	MIA25.0103.0500	NEEDLE BEARING - 8x11x9	1	46	MIA25.0100.0009	THROTTLE ROD	1
8	MIA36.0103.0003	CIRCLIP - PISTON PIN	2	47	MIA25.0100.0008	TRIGGER - SAFETY	1
9	MIA25.0103.0200	PISTON	1	48	MIA25.0100.0011	RETAINER	1
10	MIA25.0103.0001	PISTON RING	1	49	MIA25.0100.0010	CHOKE CONTROL	1
11	MIA25.0102.0102	CYLINDER	1	51	MIA25.0100.0200	AV RUBBER	2
12	MIA25.0101.0002	INSULATOR	2	52	MIGB/T879.2 5X28	ROLL PIN - 5X28	1
13	MIA25.0106.0300	EARTH WIRE - 0.5X410	1	53	MIA25.0100.0023	TRIGGER - THROTTLE	1
14	MIGB/T6191 M4X18	BOLT - M4X18	2	54	MIA45.0111.0005	SPRING - THROTTLE	1
15	MIGB/T93 M4	SPRING WASHER - M4	2	55	MIA25.0100.0025	PIPE - CARB PRESSURE	1
16	MIGB/T97.1 M4	PLAIN WASHER - M4	2	56	MIA25.0100.0024	FUEL PIPE - OUTPUT	2
17	MIA25.0106.0800	IGNITION COIL	1	57	MIA25.0100.0026	CIRCLIP	4
18	MIA25.0102.0200	ELBOW	1	58	MIA25.0100.0100	REAR HANDLE	1
19	MIA25.0103.0002	PISTON PIN	1	59	MIA25.0101.0004	PLATE - AIR CLEANER	1
20	MIGB/T1099 3X3.5X10	KEY - 3X3.5X10	1	60	MIGB/T907.4.4 M5X45	SCREW - M5X45	2
21	MIA25.0103.0400	OIL SEAL - 12X22X5	1	61	MIA45.0101.0027	SEAL	1
22	MIA25.0106.0700	FLYWHEEL ASSEMBLY	1	62	MIA25.0101.0100	CARBURETOR	1
23	MIGB/T6177.2 M8X1	NUT - M8X1	1	63	MIA25.0104.0200	BASE - AIR FILTER	1
24	MIGB/T97.1 M5	PLAIN WASHER - M5	10	64	MIA25.0104.0001	AIR FILTER ELEMENT	1
25	MIGB/T93 M5	SPRING WASHER - M5	10	65	MIA25.0104.0100	CASE - AIR FILTER	1
26	MIGB/T6191 M5X22	BOLT - M5X22	4	66	MIA25.0600.0001	OUTER COVER - AIR FILTER	1
27	MIA45.0106.0500	SPARK PLUG (CHAMPION RCJ6Y)	1	67	MIA45.0113.0005	LOCK NUT WASHER - 15X26X1	1
29	MIA25.0101.0300	AIR INTAKE TUBE	1	68	MIA45.0113.0100	LOCK NUT	1
30	MIGB/T907.4.4 M4X14	SCREW - M4X14	4	69	MIA25.0112.0000	CHAIN BRAKE ASSEMBLY	1
31	MIA25.0101.0006	SEAL	1	70	MIA25.0112.0002	LEVER - CHAIN BRAKE	1
32	MIA25.0101.0001	GASKET - MUFFLER	1	71	MIA38.0312.0200	BRACKET	1
33	MIA25.0105.0200	MUFFLER	1	72	MIA38.0312.0007	SPRING	1
34	MIA25.0105.0001	COVER - MUFFLER	1	73	MIA36.0112.0013	SCREW - M5X32	1
35	MIGB/T6191 M5X45	BOLT - M5X45	2	74	MIA25.0112.0005	SLEEVE	1
36	MIA38.0314.0005	JOINT	3	75	MIA38.0312.0011	BUSH	1
37	MIA25.0101.0003	PRESSURE PIPE - 2.5X6X48	1	76	MIA25.0112.0100	COVER - CLUTCH	1
38	MIA45.0102.0103	CLIP	3	77	MIA25.0112.0009	HEAT SHIELD	1
39	MIA25.0100.0007	COVER - TOP	1	78	MIA25.0112.0007	TENSIONER SCREW	1
40	MIGB/T845 ST4.2X16	TAPPING SCREW - ST4.2X16	7	79	MIA45.0112.0023	TENSIONER GEAR	1

## PARTS LIST

ID No.	PART NUMBER	DESCRIPTION	QTY	ID No.	PART NUMBER	DESCRIPTION	QTY
80	MIA25.0112.0006	TENSION BLOCK	1	125	MIA45.0101.0024	FELLING DOG	1
81	MIA25.0112.0008	PLATE	1	126	MIA25.0611.0001	COVER - FRONT	1
82	MIA38.0312.0010	BRAKE CONTROL ROD	1	127	MIGB/T845 ST4.8X13	TAPPING SCREW - ST4.8X13	3
83	MIA45.0112.0009	SPRING - BRAKE	1	128	MIGB/T845 ST4.2X14	TAPPING SCREW - ST4.2X14	1
84	MIA25.0112.0003	BRAKE BAND	1	129	MIA38.0311.0008	VENT TUBE - 3.5X6.5X40	1
85	MIGB/T119.2.3X9	PIN - 3X9	3	130	MIA25.0102.0200	ELBOW	1
86	MIA38.0312.0003	ACTUATOR	1	131	MIA38.0311.0100	PRIMER BULB	1
87	MIGB/T119.2.3X14	PIN - 3X14	1	132	MIA45.0111.0200	BREATHER ASSEMBLY	1
88	MIA38.0312.0004	BLOCK	1	133	MIA38.0311.0006	SEAL - BREATHER	1
89	MIGB/T845 ST4.2X12	TAPPING SCREW - ST4.2X12	10	134	MIA38.0311.0500	FUEL FILTER	1
90	MIA25.0112.0001	COVER - SPRING	1	135	MIA25.0111.0002	GROMMET - FUEL PIPE	1
91	MIA38.0312.0005	SPRING	1	136	MIA25.0111.0003	FUEL PIPE - 2.5X5xX65	1
92	MIA38.0312.0006	CAP - SPRING	1	137	MIA25.0111.0005	RETURN FUEL PIPE - 2.5X5X60	1
93	MIA25.0112.0004	SPRING - TORSION	1	138	MIA25.0111.0004	PRIMER PIPE - 2.5X5X85	1
94	MIGB/T6183.1 M5	LOCKNUT - M5	1	139	MIA25.0100.0014	SCREW - ST4.2x12	2
95	MIGB/T6177.1 M8	NUT - M8	1	140	MIA25.0100.0015	CHAIN CATCHER	1
96	MIA25.0101.0200	CLUTCH ASSEMBLY	1	141	MIA25.0100.0021	PLATE - STROP	1
100	MIA25.0101.0009	CLUTCH WASHER	1	142	MIA25.0111.0100	MAIN BODY	1
101	MIA25.0101.0007	CLUTCH DRUM	1	143	MIA25.0111.0006	HEAT SHIELD	1
102	MIA36.0101.0400	NEEDLE BEARING - 10X13X13	1	144	MIA25.0610.0000	RECOIL STARTER ASSEMBLY	1
103	MIA38.0301.0014	WORM	1	145	MIA25.0110.0006	PIPE - AIR CONDUIT	1
104	MIA25.0100.0012	COVER - OIL PUMP	1	146	MIA25.0110.0001	COVER	1
105	MIA25.0114.0002	PIPE - OIL OUTLET	1	147	MIGB/T9074.19 ST4.18X13	TAPPING SCREW - ST4.8X13	1
106	MIA38.0314.0000	OIL PUMP	1	148	MIA25.0110.0002	RECOIL PULLEY	1
107	MIA25.0101.0005	WASHER - 10X18X1.5	1	149	MIA25.0110.0003	RECOIL SPRING COVER	1
108	MIA25.0114.0001	PIPE - OIL PICKUP	1	150	MIA25.0110.0004	RECOIL SPRING	1
109	MIA45.0114.0301	OIL FILTER BODY	1	151	MIA45.0110.0008	HANDLE - RECOIL STARTER	1
110	MIA45.0114.0302	SCREEN - OIL FILTER	1	152	MIA25.0110.0005	RECOIL ROPE - 2.5X800	1
111	MIA25.0100.0013	PLATE	1	153	MIA25.0110.0101	GUIDE - ROPE	1
112	MIA25.0100.0017	DUST SHIELD	1	155	MIGB/T845 ST4.8X16	TAPPING SCREW - ST4.8x16	2
113	MIA25.0100.0018	PLATE - DUST SHIELD	1	156	MIA25.0100.0003	PLATE	1
114	MIA25.0100.0019	HEAT SHIELD	1	158	MIA25.0100.0001	HANDLE - FRONT	1
115	MIA25.0106.0400	EARTH WIRE - 0.5X175	1	159	MIA25.0100.0300	AV RUBBER	1
116	MIGB/T6191 MSX18	BOLT - MSX18	4	160	Mi07.04.1.04.001	OREGON CHAIN (Ø1P040X)	1
117	MIGB/T2672 5X16	BOLT - MSX16	1	161	Mi07.04.1.06.002	OREGON GUIDE BAR (100SDEA041)	1
118	MIA25.0111.0008	WASHER - ISOLATOR	1	162	Mi07.04.1.10.011	GUIDE BAR COVER - RED	1
119	MIA25.0100.0013	PLATE - ISOLATOR	1				
120	MIA45.0101.0800	CAP ASSEMBLY	2				

# EC Declaration of Conformity

We Mitox (Rochford Garden Machinery Ltd) - BA9 9RS (importer) declare that the product(s):

**Designation:** Chainsaw for tree/forest service with petrol engine  
**Model(s):** Mitox CS260TX Premium  
**Type/Serial No:** As per rating label on machine

**Complies with the following directive(s):**

EC Directive 2006/42/EC  
EMC Directive 2014/30/EU Electromagnetic Compatibility  
NRMM Directive 2012/46/EU  
Noise Directives 2000/14/EC & 2005/88/EC for outdoor equipment use

**The conformity assessment procedure followed was in accordance with:**

EN ISO 11681-2:2011  
EN 14982:2009

**Notified Body:**

Intertek Deutschland GmbH

**Address:**

Intertek Deutschland GmbH, Stangenstraße 1, 70771 Leinfelden-Echterdingen, Deutschland

**Authorised Signatory and Technical File Holder**

**Issue Date:** 05/10/2015 (Valid 5 Years)

**Signature:**



**Name:** Stewart Anderson  
**Position:** Managing Director  
**Company:** Mitox (Rochford Garden Machinery Ltd)  
**Address:** Wincanton Business Park  
Wincanton  
Somerset  
BA9 9RS





## Notes



## Notes

**CONDITIONS OF WARRANTY**

The manufacturer warrants the product against faulty materials and workmanship for a standard 1 year period and thereafter for the set period specific to each range from the date of purchase. Warranty does not extend to failure due to fair wear and tear.

- SP** - 1 Year
  - SELECT** - 3 Years (Subject to yearly servicing)
  - PREMIUM** - 5 Years (Subject to yearly servicing)
  - PRO** - 5 Years Domestic / 3 Years Commercial (Subject to yearly servicing)
- (Extended warranty is subject to online registration and yearly servicing)*

SP, SELECT and PREMIUM ranges used for commercial purposes have a warranty period of 3 months from the date of purchase.

The manufacturer undertakes to replace any spare parts that are classified as defective by an appointed Mitox service dealer. The manufacturer will not accept liability for the replacement of the machine, either partially or wholly, and /or consequential damages and /or interest charges either directly or indirectly.

**Warranty does not cover failure due to:**

- Insufficient maintenance.
- Incorrect fuel mixture and stale fuel.
- Abnormal use or accidental damage.
- Incorrect assembly, adjustment or operation of the product.
- Spare parts that are subject to wear e.g. bag, blades, bearings, cables, guards, deflectors, spark plugs, air filters etc.

**Neither does warranty extend to:**

- Freight and packing costs.
- Use of non-genuine spare parts i.e. those from another manufacturer.
- Use of the machine for any other purpose than that for which it was designed.
- Use and maintenance of the machine in a manner not described in the owner's manual.

As part of our policy of continuous product improvement, we reserve the right to alter or amend this specification without notice. As a result, the product may differ from the information contained herein but any alteration will only be implemented without notice if it is classified as an improvement to the above specification.

**READ THE MANUAL CAREFULLY BEFORE OPERATING THE MACHINE**

When ordering spare parts, please quote the part number, this can be found in the parts list included in this manual.

Retain your proof of purchase, without which no warranty can be offered.

**Mitox Garden Machinery**, Wincanton Business Park, Wincanton, Somerset, BA9 9RS