



48cm Rear Roller
Self Propelled Lawnmower
WERR19SP

193807002

Operator's Manual & Parts List

Please read & understand this manual, paying particular attention to the safety instructions, before use.
The manufacturer reserves the right to change the product specification and livery according to continued product improvements.

Contents

Box Contents
Product Diagram
Assembly Guidelines
Before you begin / Starting the engine
Using your mower / Safety tips
Basic Maintenance
Technical Specification
Parts List & Diagrams
Declaration of Conformity
Waranty







For Spares or Support of your Webb product, please contact us:
Tel: 01793 333212
(Mon – Fri 8.30am to 5.00pm)
Email: customerservice@webblawnmowers.co.uk

To view the full range or find out more information go to
www.webblawnmowers.co.uk

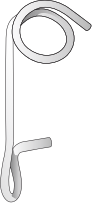

INSTRUCTION MANUAL

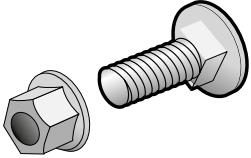
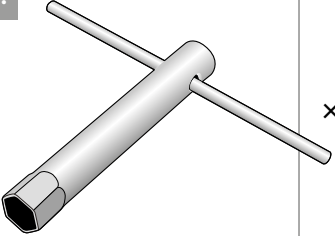
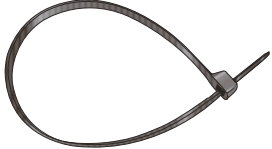
What you get with your mower

1. 	x1	2. 	x1	3. 	x2
4. 	x1	5. 	x1	6. 	x4
7. 	x1	8. 	x2	9. 	x1

1. Petrol Engine Mower

2. Instruction Manual

3. Rear Grass Catcher

4. Rope Guide

5. Spanners

6. Bolt and Nut Assembly

7. Spark Plug Socket

8. Cable Ties

9. Bolt

BOX CONTENTS / PRODUCT DIAGRAM



1. Drive Lever

2. Brake (OPC) Lever

3. Oil Filter and Dipstick

4. Muffler / Exhaust

5. Primer Bulb

6. Air Filter

7. Fuel Tank

8. Recoil Rope

9. Grass Collection Bag



INSTRUCTION MANUAL

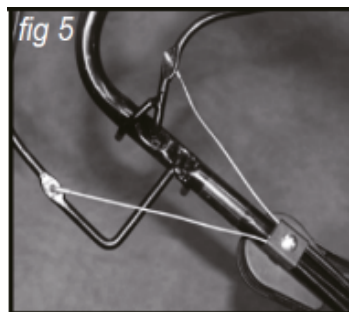
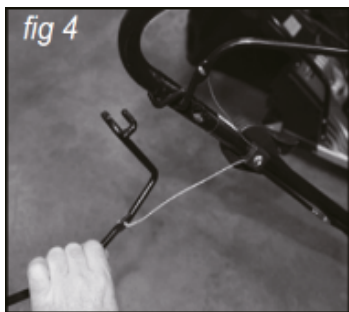
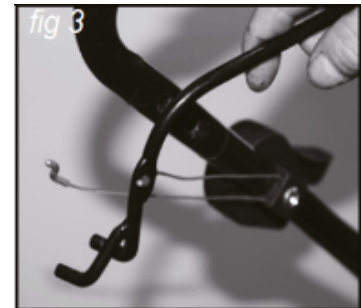
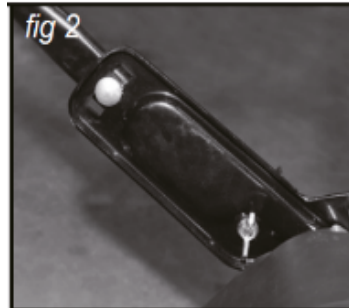
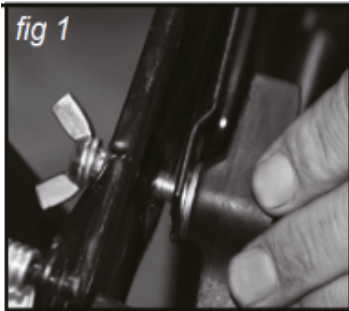

Position the handle assembly so you can fix the handle to the machine using the two fixing bolts (fig. 1)

Lift the handle to the correct height for the operator and fit the two additional bolts to secure the handle (fig. 2)

Fit the Operator Presence Cable, remove the lever from its mounting by easing it from the handle, attach the Z cable end to the OPC lever. (fig. 3) Refit the OPC lever to the handle.

Fit the Self Propelled drive cable, again remove the lever from its mounting by gently easing it from the handle, attach the Z cable end to the Self Propelled drive lever (fig. 4)

Ensure you have attached the correct cable to the correct lever (fig. 5)

Fit the rope guide to the right hand side of the handle (fig. 6)

Fit the cable router to the handle using the securing bolt supplied. This should be fitted to the inside of the handle (fig. 7)

Hold in the Operator control handle and pull on the recoil starter rope so you can attach it through the wire recoil rope guide. (fig. 8)

ASSEMBLY GUIDELINES



Grass collector & Frame.

Insert the Frame into the collector bag.

Ensure that the carry handle is located on the outside of the collector bag.

Attach the collector bag to the frame by placing the velcro around the frame.

Attach the top section first, followed by the side sections, ensuring the frame lugs are protruding through the pre-cut holes in the grass collector material.

Finish by attaching the lower holder ensuring the base of the grass collector sits inside the frame.



INSTRUCTION MANUAL

BEFORE YOU BEGIN



WARNING! The following procedures must be carried out before you start the engine of your lawnmower.



FILL OIL SUMP WITH OIL



FILL FUEL TANK WITH UNLEADED PETROL

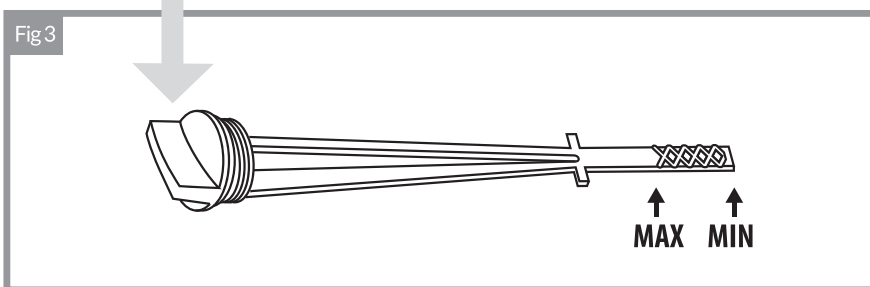
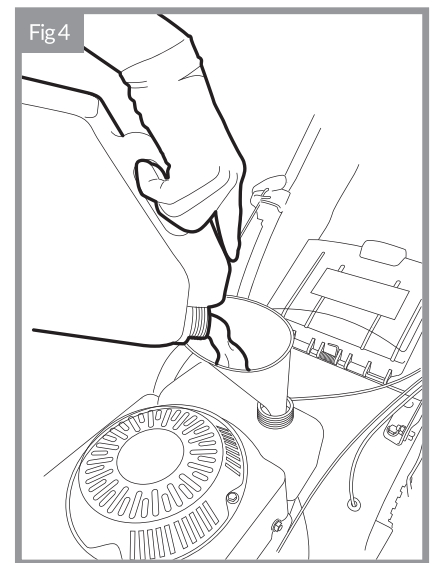
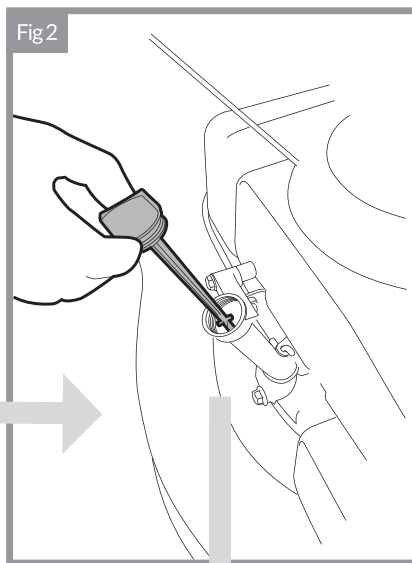
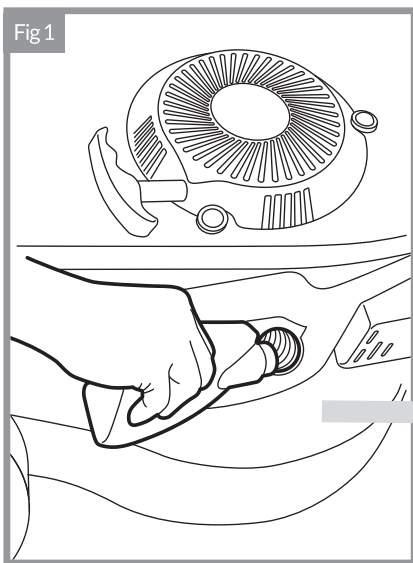

Filling oil sump with oil

The mower is supplied without oil in the engine. Refer to the B&S engine manual before starting the engine for the first time.

1. Firstly, remove the warning label from under the dipstick, then remove the dipstick and slowly pour SAE30 or 10W/30 lawnmower grade engine oil into the engine via the oil filler (as directed by the B&S engine manual). Replace the dipstick and tighten.

2. Before you use the mower each time, check the oil level (fig. 2) and if necessary top up with SAE30 or 10W/30 oil. To check the oil level, unscrew the yellow dipstick, wipe with a rag and replace into the oil filler (do not screw back in place), remove the dipstick again and check the level.
3. The oil level must be between the min and max marks on the dipstick (fig.3). Replace the dipstick and screw into place.

Fill fuel tank with unleaded petrol

Petrol is highly flammable so extreme caution must be taken when handling it. Always store petrol in approved containers and you must ensure that you use fresh petrol that is less than 4-6 weeks old. Do not mix oil with petrol.

4. To put petrol in the fuel tank, firstly remove the warning label from under the petrol cap. It's best to fill the tank using a clean funnel, but never fill it completely (fig. 4). Instead, leave at least 13mm from the bottom of the filler neck to allow for expansion. Ensure that you securely tighten the petrol cap after filling. (Funnel & fuel not supplied).

BEFORE YOU BEGIN/STARTING THE ENGINE

STARTING THE ENGINE

⚠ WARNING! The following procedures must be carried out before you start the engine of your lawnmower.

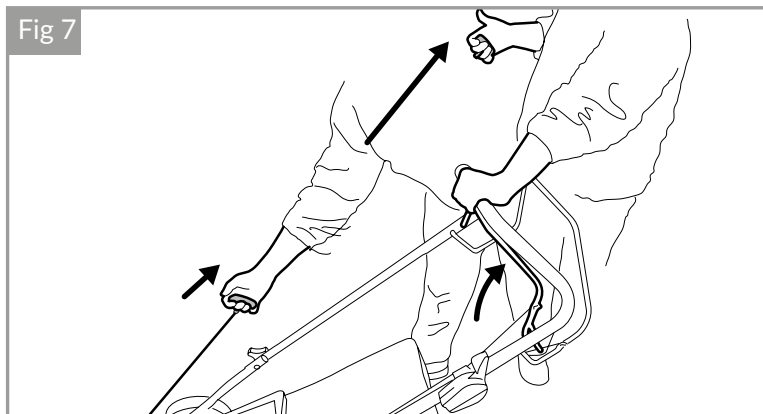

Starting the engine

1. Make sure that your mower is on a safe, flat area (a paved area or path is ideal - avoid thick wet grass and gravel surfaces) away from fuel or fueling area to make starting safe.
2. Press the fuel primer bulb 5 times.
3. Firmly hold the brake handle with one hand, and then with your other hand pull the cord slowly until you feel resistance. Then pull vigorously with one positive action (Fig. 7). Guide the cord back to its rest position (do not release).
4. To restart a hot engine, refer to 'Point 3'
5. To turn off your mower, release the brake handle.



INSTRUCTION MANUAL

USING YOUR MOWER

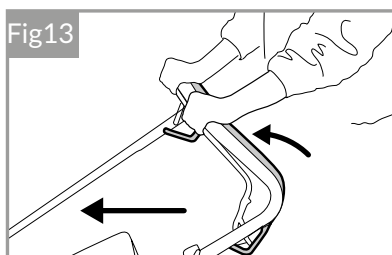
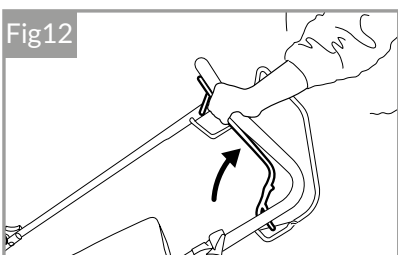
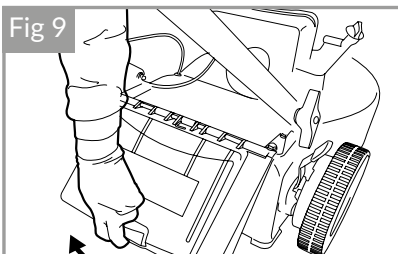

Attach the Grass Collection Bag

The grass collection bag attaches easily by lifting the mower's Rear Flap with one hand (Fig. 9) and slide the grass collection bag into position (Fig. 10).

Cutting Height Adjustment

WARNING! Turn mower off before adjusting cutting height lever

For best results adjust the cutting height of your mower to suit the mowing conditions. Do not try to remove too much grass in one pass.

Adjustment of the cutting height is made centrally. Turn off the mower and take the weight of the mower by lifting. Take hold of the cut height adjustment lever, positioned on the mower's right hand rear wheel.

Move the lever inwards to release it from its locating notch. Move the lever down machine to increase the cutting height.

To reduce the cutting height move the lever upwards. Return the lever to the locating notch to set the desired cutting height.

Make sure the handle fits snugly and securely into its serrated holder (Fig. 11).

Mowing your Lawn

Start your mower (see: Starting the engine). Keep hold of the Brake (OPC) Lever (releasing the Brake (OPC) Lever will stop the engine to avoid accidents) (Fig. 12). To power the mower forward move the Drive

Lever up and forward (Fig. 13). The mower can be pushed with the drive disengaged for more precise handling. After mowing and emptying the Grass Collection Bag ensure the engine is not running and turned off.

Cleaning your Mower

WARNING! Turn mower off before cleaning

Cut grass is damp. Regular cleaning after each use will ensure better functioning of the mower and reduce the risk of corrosion or seizure. Having finished mowing, allow the engine to cool then remove accumulated grass clippings from and around the engine with a brush. Clean the grass collection bag annually with a brush or gentle spray of water and allow to dry.

Clean underneath regularly - disconnect the spark plug cap and tilt the mower backwards. Remove cut grass with a scraper and a brush.

Do not use a pressure washer or hot water to clean the mower. Dry off the machine before storing by leaving it running for a few minutes on a flat, clean surface to prevent corrosion or seizure.

Storing your Mower

Store your mower in a dry, well-ventilated area, away from flames, sparks or heat sources. Disconnect the spark plug cap. Avoid storing beneath a tarpaulin or similar cover as it may cause condensation resulting in corrosion.

Winter Storage:

Thoroughly clean the mower. Run the engine outdoors until fuel tank is empty or empty fuel using a fuel suction pump. Dispose of discarded fuel safely and responsibly. Run the engine until remaining fuel is consumed.

Remove the spark plug from the engine. Pour a tablespoon of engine oil into the cylinder. Gently pull the starter rope several times to distribute the oil to protect the cylinder over winter. Replace and tighten the spark plug.

Transporting your Mower

Ensure the fuel tank is empty. Run the engine until any remaining fuel is consumed. Allow the engine to cool.

How to cut for best results

For best results cut your lawn in alternative directions switching direction each time you cut. Cut your lawn at an equal and regular height. Slightly overlap your cutting lines.

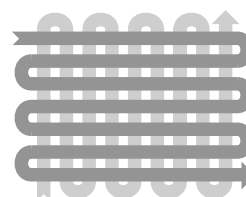





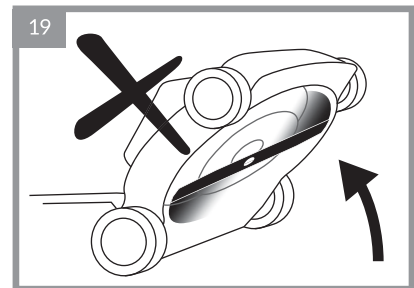
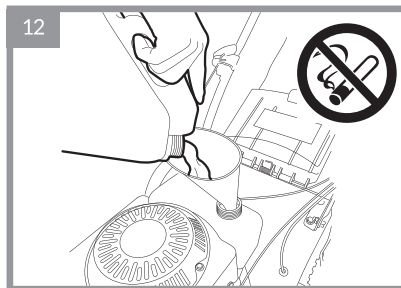
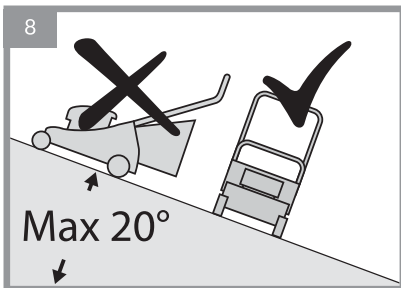
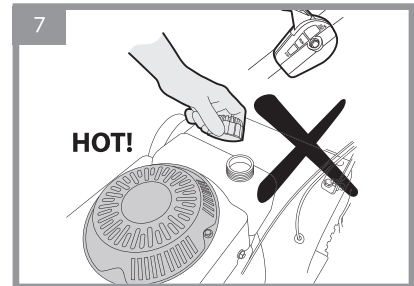
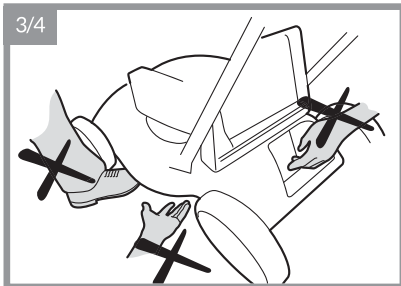

USING YOUR MOWER/SAFETY TIPS

⚠️ TIPS ON MOWER SAFETY



1. Before starting your mower inspect it carefully to ensure that there are no loose parts and that it is in good working order.
2. Be sure of your footing. Always walk, never run, when operating the lawnmower.
3. Keep hands, feet and clothing away from the mower's moving parts and always wear appropriate footwear (avoid sandals or open shoes). 
4. Never put your hands or feet underneath the chassis of the lawnmower while the engine is running.
5. Clear the area to be mowed of any stones, sticks, wire and debris before beginning. Always ensure that you mow a safe distance away (over 14 metres) from adults, children and animals.
6. Turn off the engine and disconnect the spark plug cap before cleaning, transporting, or making adjustments. Never leave the mower unattended.
7. Never open the fuel filler cap, or fill the tank, if the engine is still hot after use. Please ensure that you securely tighten the petrol cap after filling.

8. Mow across the face of slopes, not up & down, and avoid mowing on very steep slopes. We recommend you avoid mowing when it is raining, after nightfall or in poor light conditions.
9. Do not operate the machine by pulling it towards you as you risk pulling it onto your feet. Instead, always push and walk behind your lawnmower.
10. Do not fill the tank, or start the lawnmower indoors, or in a poorly ventilated area, as exhaust gases contain poisonous substances and petrol fumes are flammable and dangerous. 
11. Do not alter engine governing settings or over-rev the engine, as excessive speed is dangerous and can reduce engine life.
12. Do not smoke when filling the fuel tank, using the machine, or when petrol is in the immediate area. Never use or store the mower near a naked flame. 
13. Always use fresh premium unleaded petrol that is not more than 4-6 weeks old. Fill the tank using a funnel, but never completely. Clean up any overflow or splashes before starting. 

14. Do not transport the mower in a vehicle if there is any petrol in the tank. 
15. Be aware that the machine's exhaust area and other parts of the lawnmower get very hot during and right after use. 
16. Turn off the engine before emptying the grass-catcher and before clearing any grass caught in the rear flap where the catcher fits.
17. Store fuel and oil in a cool well-ventilated place, away from direct sunlight and gas cylinders or hot water heater systems. 
18. It is recommended that you wear ear protectors, safety goggles and safety boots when using the lawnmower.
19. To inspect the underside of your mower, only tilt the lawnmower to your right, or back, when standing behind it (this is the side where the exhaust is near the ground) otherwise oil may leak into inappropriate areas of the engine. Never tilt the lawnmower when the engine is running.
20. All servicing and repair work under warranty must be carried out by an Authorised Dealer, otherwise the 1+1-Year warranty may be void.



INSTRUCTION MANUAL

MAINTENANCE SCHEDULE



WARNING! The following procedures must be carried out before you start the engine of your lawnmower.

SUMMARY OF REGULAR MAINTENANCE REQUIRED BY THE MOWER

Frequency	Before each mowing	After 5 hours	Every 25 hours or once a year minimum before winter lay-up
Components			
Cutting system	Check and verify its condition		Sharpen and balance blade. Replace worn or damaged blade.
Spark plug		Check	Clean and check the clearance of the electrodes. Replace if necessary.
Air Filter		Check	Clean the filter. Replace if necessary.
Oil	Check the level	Drain and renew	Drain and renew

Cutting System

Before and after each mowing session, check that the blade, its attachment bolts and drive shaft are not damaged or excessively worn. Never try to straighten a bent blade. Replace a damaged, worn or bent blade as soon as possible. Use only genuine WEBB parts or those approved by WEBB.

Excessive vibration when mowing is a good indication of a problem with the cutting system.

Vibration from a bent or damaged blade can cause costly damage to the mower. Working with an excessively worn blade wastes fuel and can lead to injury if the blade becomes detached from the machine.

WARNING!

Removing the blade

Wear appropriate protective gloves to prevent possible injury when handling the blade. Disconnect the spark plug cap and tilt the mower on its side with air filter and carburettor side uppermost.

Holding the blade firmly in one hand, use a spanner or socket to loosen the blade screw & rotate anti-clockwise.

The spark plug cap must be removed before any attempt is made to remove the blade

WARNING!

Sharpening the blade

For best mowing results, have the edges sharpened and the blade balanced at least once a year by a specialist service dealer or agent.

Mounting the blade

Wear appropriate protective gloves to prevent possible injury when handling the blade. Disconnect the spark plug cap and tilt the mower on its side with air filter side uppermost.

Check that all components (the blade, key, blade holder, screws and washers) are present, clean and in good condition.

Position the blade on its support with the cooling fins facing the engine.

Check the correct alignment and matching of pads with the blade. The blade must be positioned precisely on its stand.

Tighten the screws connecting all of the components. Make a final visual check that all parts are present and aligned before tightening the fixing bolt very firmly with a wrench while holding the blade firmly in one hand (NB wear suitable gloves). Rotate clockwise

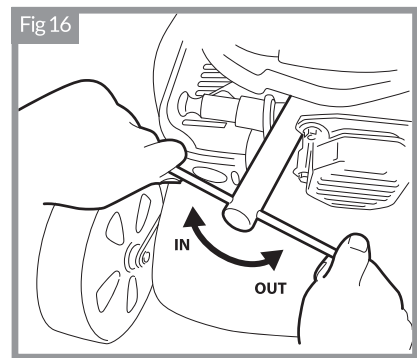
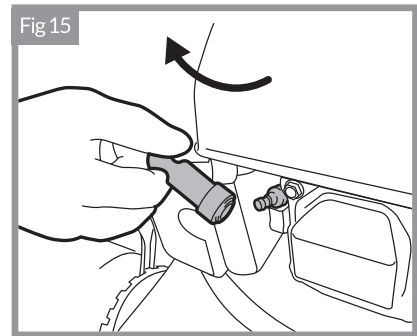

Spark Plug

Check the spark plug initially after the first five hours of mower use. Thereafter, maintenance of the spark plug should take place every 25 hours.

Remove the spark plug cap (Fig.15) using a rotary motion and then remove the spark plug with the wrench provided (Fig.16).

Clean off any carbon deposits using a copper brush and check the electrode gap with a feeler gauge (the gap should be ≈ 0.7 mm). Replace and tighten the serviced spark plug and replace the cap.

If the spark plug is worn or damaged, replace with a new spark plug of the same or suitable type for the engine. If in doubt, contact your point of purchase or local dealer.

Always refer to your B&S manual.

BASIC MAINTENANCE

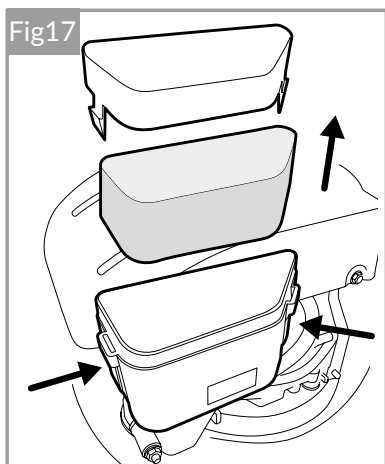

WARNING! Do not twist the foam cartridge to clean it as this could cause damage. If your mower is not serviced correctly, you could reduce your mower's ability to operate and void warranty.

Air Filter

An air filter in poor condition will reduce the performance and life of the engine while making it harder to start. Regular checks are therefore essential, especially when using the mower in dusty conditions. Check and clean the air filter every 25 hours of use or more often if the engine is used in a dusty environment.

Remove the air filter cover lid and carefully remove the foam filter cartridge. Clean the cartridge in a small bowl of warm water containing a few drops of washing-up liquid until it is perfectly clean and free from all traces of grease and dust. Rinse the filter cartridge in clean water and then squeeze gently to remove most of the water. Let it air dry until it is completely dry.

Clean the cover and inside of the air filter box with a clean lint-free cloth. Apply a uniform layer of oil to the outside of the cartridge filter with a brush (you can use clean engine oil for this). Insert the filter cartridge into its housing and replace the filter lid, ensuring that each component is in place and properly installed. If the filter cartridge is damaged or is very dirty, replace it using a genuine part.

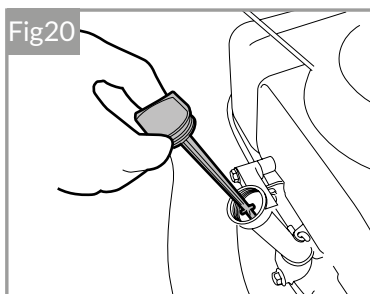
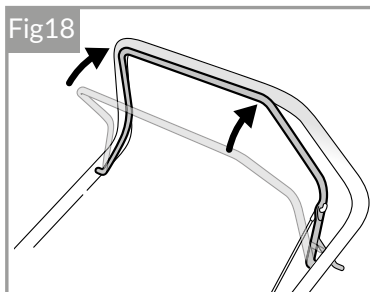

Adjusting the transmission cable

In its transmission engaged position (Fig. 18), the mower's Brake

Lever is pushed fully towards the handlebar. An incorrectly adjusted transmission cable can cause premature wear to the mower's drive system.

If the transmission cable is too tight, it will be difficult to move the drive lever towards the handlebars. Conversely, if the transmission cable is not tight enough, the transmission will function poorly and will lack power.

To adjust the tension of the cable transmission, increase or reduce the length of the adjustment device using the spanner (Fig. 19). Check the effectiveness of the transmission and the resistance of the lever.

Once proper adjustment has been reached, secure the adjustment device by tightening the lock nuts.

Note: Depending on model.

Checking the oil level

Position the mower on a firm, level surface. Unscrew the oil level dipstick (Fig.20) and wipe dry. Insert the dipstick until it reaches the filler neck, but do not screw

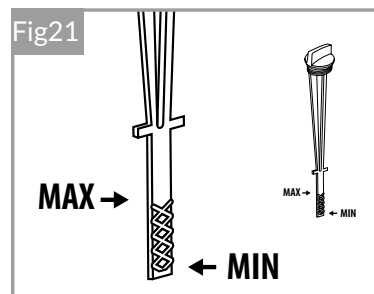
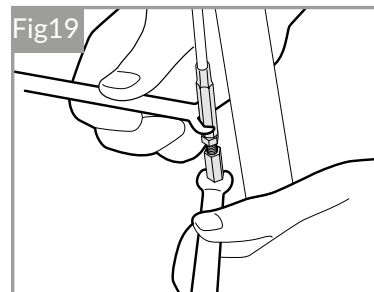

in. Remove the dipstick and check the oil level holding the dipstick horizontal.

The oil level should be between the minimum and maximum oil level marks on the dipstick (Fig.21). Add oil if necessary and repeat the above checking process. Running the engine without oil or with too little oil can cause serious engine damage.

Note: Dispose of used engine oil carefully, responsibly and in accordance with local or national regulations

Changing the oil

The first oil change should be carried out after the first 5 hours of mower use. Thereafter, change the oil after every 25 hours use or at least once a year. Leave the engine running outdoors for several minutes to warm the oil and make it more fluid.

WARNING! Parts of the engine will become very hot and can cause severe burns.

Remove the spark plug cap and unscrew the oil level dipstick. Use a suitable oil suction pump and follow its instructions, then fill the engine with new oil.

WARNING! The above advice is provided as an aid, please follow the instructions provided in your B&S engine manual, when maintaining your engine.



INSTRUCTION MANUAL

TECHNICAL SPECIFICATION

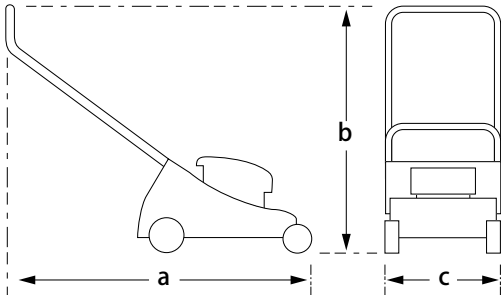

Consistent with our policy of continuous improvement, WEBB reserves the right to change the design and configuration of any of its products without notice or obligation.

Therefore, please treat the text and images in this manual as being for illustrative purposes only. They may in no case serve as a basis for any legal claim.

	WERR19SP
Maximum Operating Speed	3600 rpm
Cutting Width	48cm / 19"
Adjustable Cutting Heights	6
Cutting Heights	20-65mm
Grass Collection Capacity	60 L
Noise Level	96 dB
Chassis	ABS
Dimensions (cm)	a = 165. b = 107. c = 52

Function

Collection

FAST TROUBLE SHOOTING

Problem	Likely cause	Suggested remedy
Engine does not start	Out, or almost out, of fuel	Fill tank with min unleaded petrol
	Spark plug depleted	Replace with a suitable new spark plug
	Spark plug dirty	Clean or replace with a new spark plug
	Spark plug not connected	Press firmly on the terminal cover
	Flooded engine	Remove Spark Plug, clean with appropriate cloth and refit
	Old petrol in the tank	Drain stale fuel and replace with new min unleaded petrol
	Water in the fuel tank	Contact an authorised dealer
Engine stops often	Blocked fuel supply	Ensure the fuel line is not pinched or blocked
	Fuel cap is not venting	You may need to slightly loosen the fuel cap
	Wrong type of fuel	Drain petrol tank and fill with new min unleaded petrol
Engine loses power	Dirty air cleaner filter	Clean or replace with a new air-filter
	Incorrect height adjustment	Raise the mower's cutting height lever
	Blocked fuel cap vent holes	Ensure the 3 holes in the fuel tank cap are clear
Mower vibrates too much	Loose cutting blade	Check and tighten bolts and nuts
	Bent or broken disc/blades	Replace disc or blades
	Excessive grass/dirt build-up	Clean and ensure underside clear of build up
	Disc or blades worn/damaged	Replace blades
Poor cutting catching	Catcher not fitted correctly	Reattach carefully and also check for damage
	Incorrect cutting height set	Adjust the cutting height
	Blocked grass catcher vents	Clear and clean the vents



EC DECLARATION OF CONFORMITY

We Handy Distribution Ltd - SN3 5HY (Importer) declare that the product:

Designation: Petrol Lawnmower

Model(s): WERR19SP

Type/Serial No. As per rating label on machine

Complies with the following directives:

2006/42/EC- Machinery Directive

2004/108/EC- Electro-Magnetic Compatibility Directive

2000/14/EC Annex VI and 2005/88/EC- Noise Emission in the Environment by Equipment for use Outdoors Directive.

The conformity assessment procedure followed was in accordance with

EN ISO 5395-1:2013

EN ISO 5395-1:2013

EN ISO 14982:2009

Notified Body:

TÜV SÜD Product Service GmbH

Addresses:

Ridlerstrasse 65-80339 München (Germany)

Westendstrasse 65-80686 München (Germany)

No. 88 Heng Tong Road, Shanghai 200070, (P.R. China)

Measured Sound Power Level: 94dB(A)

Guaranteed Sound Power Level: 96dB(A)

Authorised signatory and technical file holder

Date: 03/11/2015

Signature:

A handwritten signature in black ink, appearing to read "S Belcher", written over a horizontal line.

Name: Mr Simon Belcher

Position: Managing Director

Company: Handy Distribution Ltd

Address: Murdock Rd, Swindon, Wiltshire, SN3 5HY.



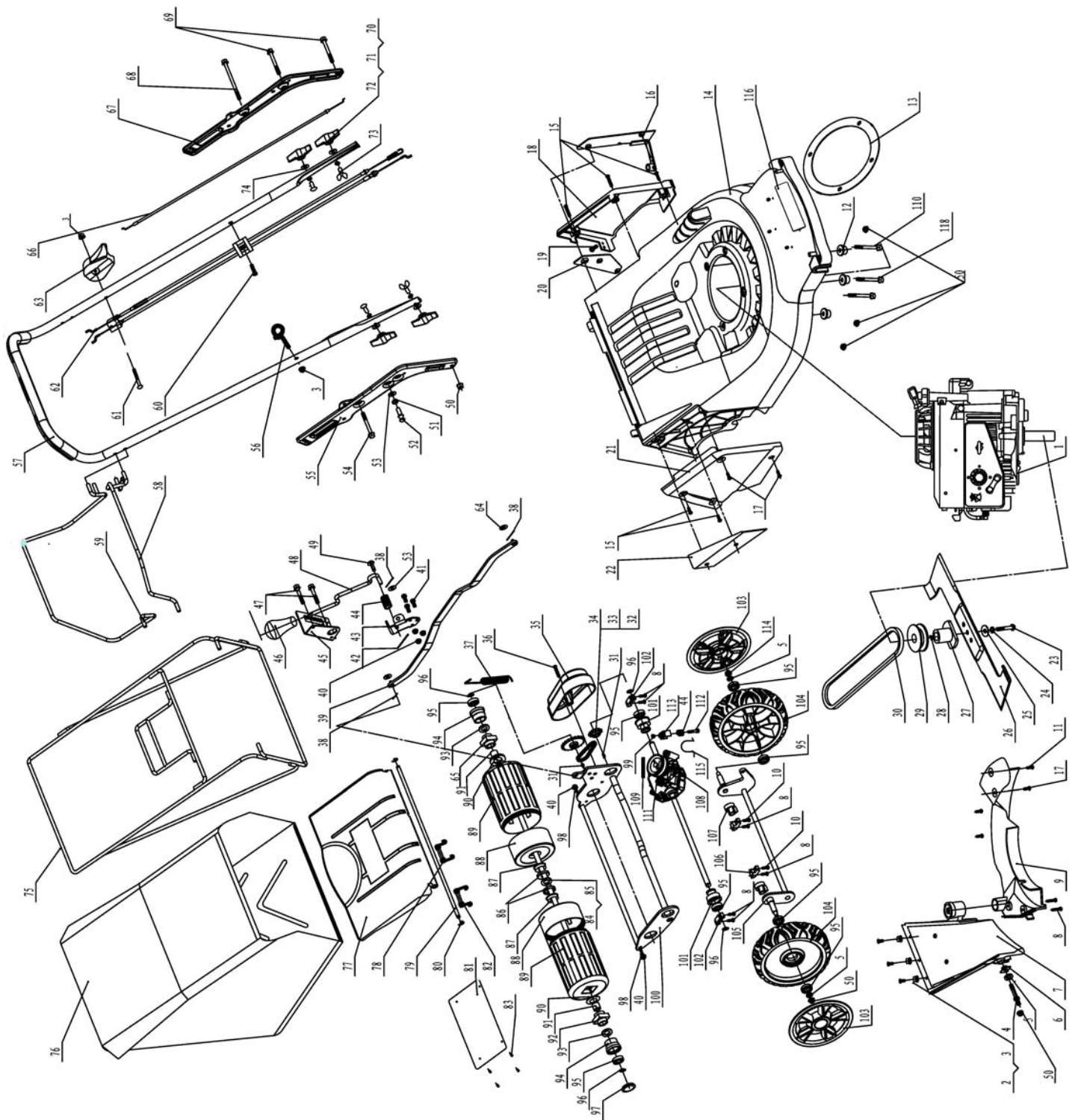

No.	Webb Part No	Description	Qty
1	WE107-01	Engine (5.5HP)	1
2	WE107-02	M6x16 Bolt	3
3	WE107-03	M6 Nut	5
4	WE107-04	Bolt	1
5	WE107-05	Washer	3
6	WE107-06	Nut	1
7	WE107-07	Plastic Plate	1
8	WE107-08	Self Tapping Screw	8
9	WE107-09	Belt Cover	1
10	WE107-10	Self Tapping Screw	2
11	WE107-11	Self Tapping Screw	1
12	WE107-12	Bush	3
13	WE107-13	Washer	1
14	WE107-14	Deck (ABS)	1
15	WE107-15	Self Tapping Screw	5
16	WE107-16	LH Lower Support Plate	1
17	WE107-17	Self Tapping Screw	5
18	WE107-18	LH Lower Handle Cover	1
19	WE107-19	M5x16 Bolt	1
20	WE107-20	Bracket	1
21	WE107-21	RH Lower Handle Cover	1
22	WE107-22	RH Lower Support Plate	1
23	WE107-23	Blade Bolt 3/8"-24UNF-2B	1
24	WE107-24	Washer	1
25	WE107-25	Washer 10.5x30x3	1
26	WE107-26	Blade	1
27	WE107-27	Blade Boss	1
28	WE107-28	Key 4.8x6.5x16	1
29	WE107-29	Crankshaft Pulley	1
30	WE107-30	A787 Belt	1
31	WE107-31	Key 3x5x13	2
32	WE107-32	11T Sprocket	1
33	WE107-33	20T Sprocket	1
34	WE107-34	Chain 06B-1x37	1
35	WE107-35	Chain Cover	1
36	WE107-36	M6x40 Bolt	1
37	WE107-37	Spring	1
38	WE107-38	2x20 Pin	3
39	WE107-39	Connecting Bar	1
40	WE107-40	Washer/Nut	5
41	WE107-41	M6x16 Bolt	3
42	WE107-42	3.2x20 Pin	1
43	WE107-43	Bracket	1

No.	Webb Part No	Description	Qty
44	WE107-44	Spring	2
45	WE107-45	Height Of Cut Quadrant	1
46	WE107-46	Height Of Cut Handle	1
47	WE107-47	M6x30 Bolt	2
48	WE107-48	Height Of Cut Lever	1
49	WE107-49	8x24 Pin	1
50	WE107-50	M6 Nut	5
51	WE107-51	Washer	1
52	WE107-52	Bolt	1
53	WE107-53	Washer	2
54	WE107-54	M8x35 Bolt	1
55	WE107-55	RH Lower Handle Bracket	1
56	WE107-56	Recoil Rope Guide	1
57	WE107-57	Soft Grip Handle	1
58	WE107-58	OPC Lever	1
59	WE107-59	Drive Lever	1
60	WE107-60	M6x30 Bolt	1
61	WE107-61	M6x52 Bolt	1
62	WE107-62	Drive & OPC Cable	1
63	WE107-63	Throttle Control Unit	1
64	WE107-64	Washer/Nut 10.5x16x1.5	2
65	WE107-65	LH Bearing Housing	1
66	WE107-66	Throttle Cable	1
67	WE107-67	LH Lower Handle Bracket	1
68	WE107-68	M8x75 Bolt	1
69	WE107-69	M8x50 Bolt	2
70	WE107-70	Wing Nut	4
71	WE107-71	M8x25 Bolt	2
72	WE107-72	Washer	2
73	WE107-73	Wing Bolt M8x35	2
74	WE107-74	Washer 10.5x20x2	4
75	WE107-75	Grass Bag Frame	1
76	WE107-76	Grass bag	1
77	WE107-77	Rear Deflector	1
78	WE107-78	RH Rear Deflector Spring	1
79	WE107-79	Rear Deflector Axle	1
80	WE107-80	Circlip	2
81	WE107-81	Rear Deflector Plate	1
82	WE107-82	LH Rear Deflector Spring	1
83	WE107-83	Rivet 3.8x9.5	4
84	WE107-84	Roller Axle	1
85	WE107-85	Washer	1
86	WE107-86	Dust Shield	2

No.	Webb Part No	Description	Qty
87	WE107-87	Bearing 12x28.6x32	2
88	WE107-88	Roller Cover	2
89	WE107-89	Roller	2
90	WE107-90	Washer	2
91	WE107-91	Bearing HF-1216	2
92	WE107-92	RH Bearing Housing	1
93	WE107-93	Ring	2
94	WE107-94	Bearing Housing	2
95	WE107-95	Bearing 6001-2RS	8
96	WE107-96	Circlip	4
97	WE107-97	Cap	1
98	WE107-98	Washer	2
99	WE107-99	M6 Nut	1
100	WE107-100	Rear Axle	1
101	WE107-101	Bearing Housing	2
102	WE107-102	Gland	2
103	WE107-103	Hub Cap	2
104	WE107-104	Front Wheel	2
105	WE107-105	Front Axle	1
106	WE107-106	Gland	2
107	WE107-107	Bush	2
108	WE107-108	Gearbox	1
109	WE107-109	5x40 Pin	1
110	WE107-110	M8x60 Bolt	2
111	WE107-111	Gearbox Pulley	1
112	WE107-112	Rivet 5.5x19	1
113	WE107-113	Bracket	1
114	WE107-114	M8 Nut	1
115	WE107-115	Clip	1
116	WE107-116	Decal	1



INSTRUCTION MANUAL

This Service Book is provided with your Webb, to help you look after your purchase to our recommendations and enable you to take advantage of the 2 year conditional manufacturer domestic warranty*.

* Commercial/Professional & Hire users receive a 90 day warranty

Present this service book to your authorised Webb repair dealer, whenever a service or a warranty appraisal is required.

The booklet is applicable to the following products, in the UK only:

- Ride On Lawn Tractors
- Petrol & Electric Cylinder Lawnmowers
- Petrol Rotary Lawnmowers
- Petrol Hand Held Range

Please register your machine using the following pages or at www.webblawnmowers.co.uk. By registering your machine, you agree to maintain the machine in accordance with the service schedules specified in this manual and services duly recorded. You may be asked to produce this booklet as proof of servicing in the event of a claim. Proof of purchase should also be kept as a reference.

Ensure you have the following information available from your machine product label. The two examples below can be found on your machine:

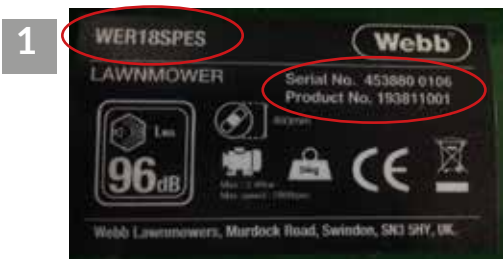

1

2

1. Model Number

2. Serial & Product Number

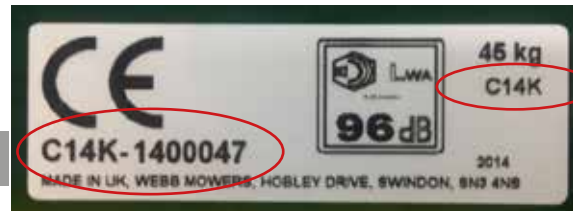

3

4

- Cylinder Mowers Only
3. Serial Number

 4. Model Number

Please complete using BLOCK CAPITALS.
Sections marked* must be completed to validate Warranty.

1. Users Statement of Warranty

Each new machine is warranted against defective material or assembly of material under normal usage. The warranty applies to the original purchaser, is not transferable and covers faulty parts and the labour involved in replacing and repairing those parts, which are of original manufacture.

2. Period of Warranty

2 year conditional warranty from the original date of sale to the first domestic user.

90 days from the original date of sale to the professional/commercial or for hire user.

Engine warranty as per the engine manufacturer's warranty, which will be supplied with the machine.

90 days from the original date of sale for Replacement Spare Parts

All machines' must be serviced within the first 14 months from the original date of purchase, to qualify for a second year parts & labour warranty, details of the service must be recorded in the service record within this manual.

A reduced warranty period of 90 days applies to those items which are subject to normal wear and tear and in normal use, will need replacement or adjustment.

These items are chargeable after 90 days of ownership.

Filters
Tyres / Wheels
Drive chains and belts
Brake & clutch friction components
Control cable & starter cords
Fluids & lubricants
Spark plugs
Blades (Lawnmowers & Brushcutters)
Cutter bars (Hedgecutters)
Drive & clutch cable surfaces
Nylon Lines (Line Trimmers)
Carburettor cleaning
Bearings
Bushes
Electric cable
Grass collectors

3. Not covered by this warranty

(a) The warranty policy does not cover any depreciation or damages caused by ordinary wear, rusting or corrosion, lack of correct maintenance or operation, misuse, abuse, lack of transportation or accident.

(b) The warranty policy does not cover any costs necessary for the standard periodic maintenance services instructed by the operators manual, or service parts replacement which would include oil, filters, tyres, belts, brake linings, fuses, blades, seals and other service parts unless it can be proven that the item has evidence of faulty manufacture.

(c) The warranty policy will not cover failure or damage caused as a result of parts or accessories being modified without the written approval of GJ Handy & Co Ltd.

(d) The warranty policy will not cover the unit if non-genuine parts have been fitted and as a result damage has occurred to the unit.

(e) The warranty policy is non-transferable and is only applicable to the original purchaser.

4. Disclaimer

(a) This warranty is only a remedy for defect of products. GJ Handy & Co Ltd will never warranty in terms of the merchantability or the fitness for a particular purpose.

(b) No person is authorised to make any warranties, representations or promises, expressed or implied, on behalf of GJ Handy & Co Ltd, or to modify the terms conditions or limitation of this warranty policy in any way.

(c) Neither GJ Handy & Co Ltd nor any company affiliated with GJ Handy & Co Ltd shall be liable in any event or manner whatsoever for incidental or consequential damages or injuries, including, but not limited to, loss of crops, loss of profit, out of pocket expenses or profits, rental of substitute equipment or other commercial losses.



INSTRUCTION MANUAL

5. General

- (a) Most warrantable failures show up within the first few weeks of use. These failures are usually straightforward and warranty assessment is relatively easy.
- (b) Failures relating to cutter decks and belts need careful investigation, as the cause may not always be straightforward. Look for damage to blades and pulleys especially when the cutter belt or blade boss have snapped or cracked as this could be due to impact damage.
- (c) Customers should always refer to the operator/instruction manual when any disputed problem arises, you will find most areas covered within the manual.

Protecting your machine

Maintenance

Regular maintenance of your Webb machine is essential to ensure it operates, safely, efficiently and therefore reducing the environmental impact.

It is the owner's responsibility to ensure that their Webb machine is maintained at specific intervals. Any approved Webb service dealer can undertake a service, which are specialised in our products and will be aware of your particular machine and any technical updates which will save valuable time & money.

If you are using your machine in dry, dusty or high temperatures, you will need to service the machine more regularly.

Fuel

Due to ongoing efforts by fuel companies to reduce emissions, unleaded petrol will oxidize & deteriorate in storage overtime, leaving residue from detergent components.

Fuel deterioration problems may occur when petrol is stored for over 30 days. If you are planning to store fuel for over 30 days, we recommend you add Handy Parts Sure-Start fuel stabilizer to fresh fuel after purchasing. Sure-Start cannot reconstitute stale fuel.

Storage

When storing your machine for an extended period, we do recommend that you follow the instructions of engine instruction manual.

Always store the fuel in a clean, approved and sealed container. If the container is steel, ensure it is not corroded.

If the container is not filled to its recommended capacity, air can accelerate fuel deterioration.

Always store fuel away from direct sunlight, in a dark, cool environment.

SERVICE BOOK

Your servicing Webb approved dealer will stamp & date the below relevant sections, when the correct service actions have been completed.

PLEASE ENSURE THE SERVICE BOOK IS AVAILABLE FOR THE DEALER, DURING SERVICE WORK.

1st Service

This must be stamped by an approved service dealer to qualify for a free second year warranty.

12 Months

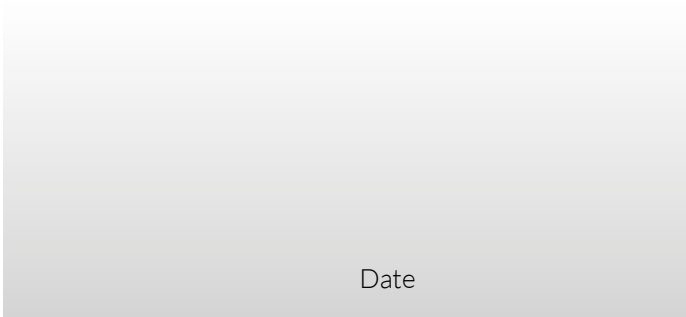

Date

24 Months

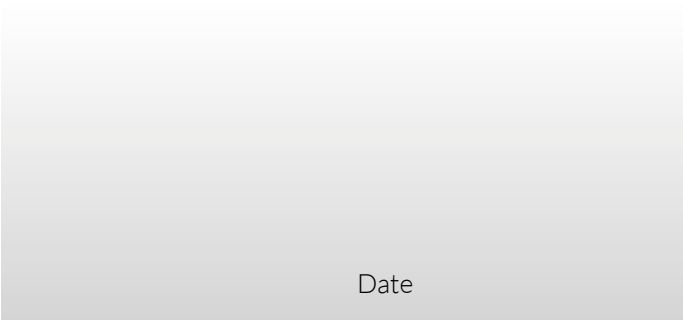

Date

36 Months

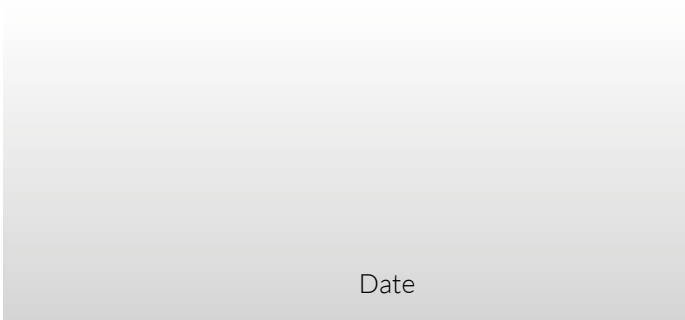

Date



INSTRUCTION MANUAL

48 Months

60 Months

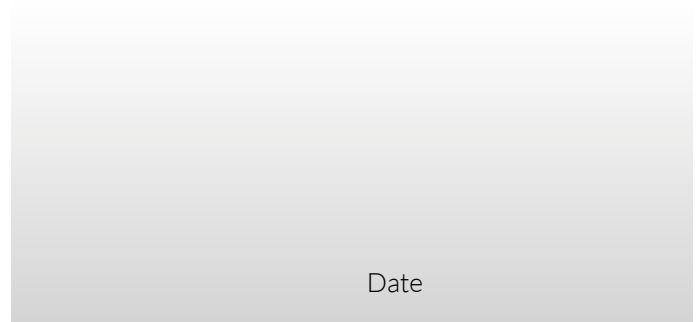
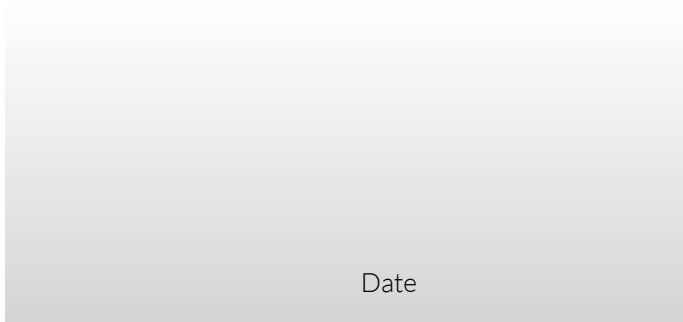

72 Months

84 Months

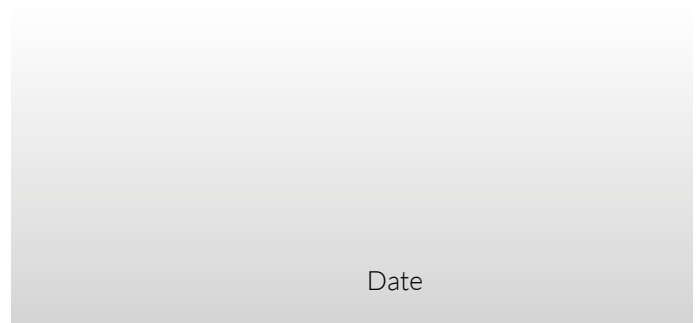
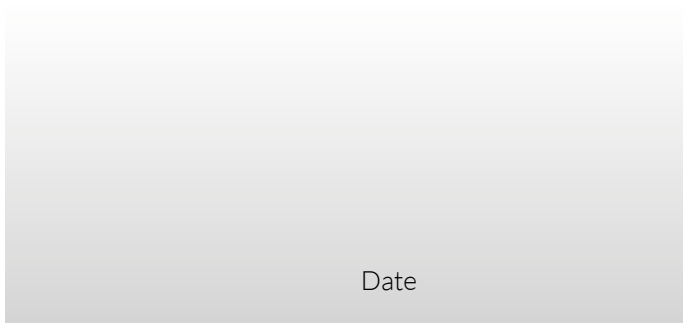

96 Months

108 Months

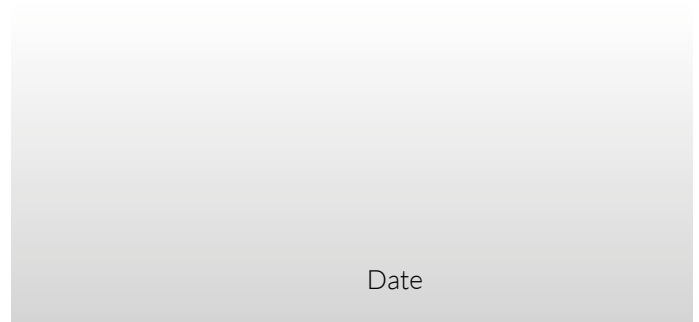
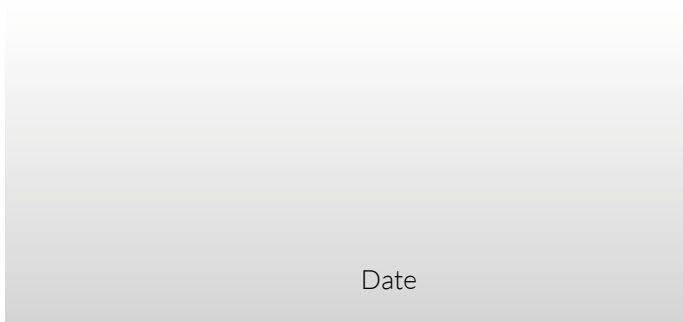

120 Months

132 Months

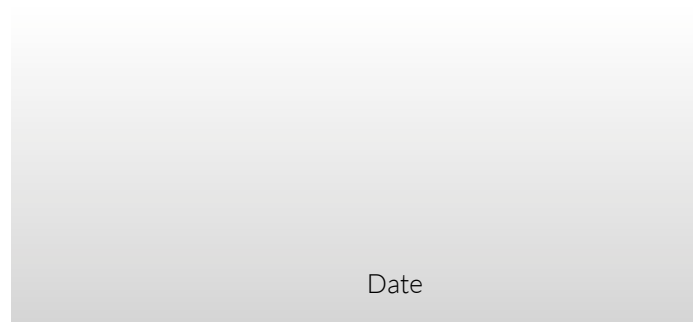
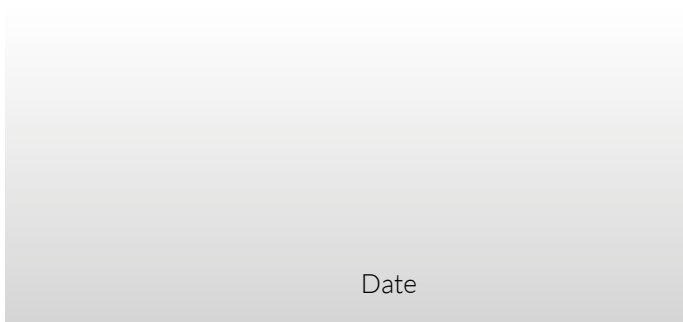

WARRANTY REGISTRATION

If you have registered online, this form is not necessary.
PLEASE POST THIS COPY TO THE ADDRESS OVERLEAF

Product Information (* Compulsory)

*Model No:	
*Product No:	
*Serial No:	
*Date of Purchase:	

Personal Information (* Compulsory)

*Title		*Forename		*Surname	
--------	--	-----------	--	----------	--

*House Number		*House Name	
---------------	--	-------------	--

*Address 1

*Address 2	
------------	--

*Town

*County	
---------	--

*Postcode

Home Tel		Mobile Tel	
----------	--	------------	--

Email

Age	18 to 25		26 to 35		36 to 45		46 to 60		61 to 80		81 & over
-----	----------	--	----------	--	----------	--	----------	--	----------	--	-----------

*Dealer Stamp (Complete Address)



*Selling Retailer (If dealer stamp not available)

*Dealer Name	
--------------	--

*Dealer Address	
-----------------	--

--	--

*Date of Purchase

*Usage	Domestic Use		Commercial/Professional/Hire Use	
--------	--------------	--	----------------------------------	--

Webb Lawnmowers privacy commitment to machine owners: Thank you for completing this form. The information supplied, helps us to improve the products & services we provide, including information that we believe is relevant to your and/or your machine. We value your trust by giving us this information about yourself and we are committed to protecting your privacy. From time to time Webb, its associated companies, authorised dealers or third parties working on our behalf may wish to contact you regarding our products, services, offers, technical improvements or just opinions, which may be used for marketing, research or analysis purposes.

If you DO NOT wish to be contacted by either of the following methods, please tick the relevant box POST TELEPHONE
If you would like us to contact you by Email, please tick this box

You may give Webb Lawnmowers notice in writing at any time that you no longer wish to receive direct marketing communications

Webb Lawnmowers
Murdock Road
Dorcan
Swindon
Wiltshire
SN3 5HY