

WEIBANG®

GARDEN MACHINES

Yangzhou Weibang Garden Machine Company Limited
Hanjiang Industrial Park, Yangzhou City, Jiangsu
Province 225127, P. R. China

Lawn Mower

Model Numbers:

WB386HC-M WB386HKL-M
WB454HB WB454HB-2IN1 WB454HB-3IN1 WB454SB WB454SB-3IN1
WB456HKL WB456HKL-3IN1 WB456SKL WB456SKL-3IN1 WB456SKL V-3IN1
WB455HC WB455HC-2IN1 WB455HC-3IN1 WB455SC WB455SC-3IN1 WB455SC V-3IN1
WB456HC WB456HC-3IN1 WB456SC WB456SC-3IN1 WB456SC V-3IN1
WB466SC-M WB466SKL-M WB466SB-M-DOV WB466SK V-M
WB506HB-DOV WB506SB-DOV WB506SB-3IN1-DOV WB506SB V-3IN1-DOV
WB506HKL WB506SKL WB506SKL-3IN1
WB506HC WB506SC WB506SC-3IN1 WB506SC V-3IN1
WB536SB-DOV WB536SB-3IN1-DOV WB536SB V-3IN1-DOV
WB536SKL WB536SKL-3IN1 WB536SKL V-3IN1
WB536SK WB536SK-3IN1 WB536SK V-3IN1
WB537SLC WB537SLC V-3IN1 WB537HCU
WB537SC-M WB536SKL-M WB536SB-M-DOV WB536SK V-M
WB456SC E, WB456SC V E, WB456SC E-3IN1, WB456SC V E-3IN1
WB506SC E, WB506SC V E, WB506SC E-3IN1, WB506SC V E-3IN1



Operator's manual
(Original instruction)



M0103070

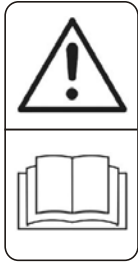

General hazard safety alert

Read Operator's manual



Beware of thrown or flying objects to bystanders.

Keep bystanders away from the machine.



Beware of sharp blades

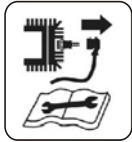

Remove spark plug before maintenance



Caution - Do not touch rotating cutting means



Never operate the lawn mower with discharge chute open



Do not mow excessively steep slopes, mow a cross the face of slopes, never up and down



Never pick up or carry a lawnmower while the engine is running, Use extreme caution when reversing or pulling the lawnmower towards you.



The guaranteed value is: L_{WA}=96dB(A)

WB454HB WB454HB-2IN1 WB454HB-3IN1 WB454SB WB454SB-3IN1
WB456HKL WB456HKL-3IN1 WB456SKL WB456SKL-3IN1 WB456SKL V-3IN1
WB455HC WB455HC-2IN1 WB455HC-3IN1 WB455SC WB455SC-3IN1 WB455SC V-3IN1
WB456HC WB456HC-3IN1 WB456SC WB456SC-3IN1 WB456SC V-3IN1
WB386HC-M WB386HKL-M
WB466SC-M WB466SKL-M WB466SB-M-DOV WB466SK V-M
WB506HB-DOV WB506SB-DOV WB506SB-3IN1-DOV WB506SB V-3IN1-DOV
WB506HKL WB506SKL WB506SKL-3IN1
WB506HC WB506SC WB506SC-3IN1 WB506SC V-3IN1
WB456SC E, WB456SC V E, WB456SC E-3IN1, WB456SC V E-3IN1,
WB506SC E, WB506SC V E, WB506SC E-3IN1, WB506SC V E-3IN1



The guaranteed value is: L_{WA}=98dB(A)

WB536SB-DOV WB536SB-3IN1-DOV WB536SB V-3IN1-DOV
WB536SKL WB536SKL-3IN1 WB536SKL V-3IN1
WB536SK WB536SK-3IN1 WB536SK V-3IN1
WB537SLC WB537SLC V-3IN1 WB537HCU
WB537SC-M WB536SKL-M WB536SB-M-DOV WB536SK V-M



Keep hands and feet away.



Wear eye and ear protection.

English

- Read the operating instructions before you use the machine!
- Keep third parties away from the danger zone!
- When you are reading the instructions for use, Please unfold the front and back pages.

CONTENT

SAFETY REGULATIONS 01-04

 General Operation 01

 Slope Operation 01

 Children 02

 General Instruction For Operation 02

 Product Specifications 03

ASSEMBLY 04

 To remove lawn mower from carton 04

 How to set up your lawn mower 04

 To assemble grass catcher 04

OPERATION 05-10

CUSTOMER RESPONSIBILITIES 10-12

SERVICE AND ADJUSTMENTS 13

STORAGE 13-14

TROUBLESHOOTING POINTS 14-15

WARRANTY 16

SAFETY REGULATIONS

I. General Operation

- Users need adequate training.
- Before starting to use this machine, read, understand and follow all instructions that are provided in this manual. Be thoroughly familiar with the controls and the proper use of the machine before starting operations.

WARNING: Do not put your hands or feet near or under rotating parts. Keep clear of the discharge opening at all times.

- This machine may only be operated by responsible persons, who are familiar with the operating instructions. Never allow children or people unfamiliar with these instructions to use the lawnmower. Local regulations can restrict the age of the operator.
- To prevent injury, be sure that there are no persons in the immediate area where you are mowing. If any person enters this area, stop the machine by releasing the drive control bar. Never mow while people, especially children, or pets are nearby.
- Keep in mind that the operator or user is responsible for accidents or hazards occurring to other people or their property.

CAUTION: Do not operate the mower when barefoot or while wearing open sandals. Always robust footwear when mowing.

- While mowing, always wear substantial footwear and long trousers. Do not operate the equipment when barefoot or wearing open sandals.
- Thoroughly inspect the area where the equipment is to be used and remove all such objects as rocks, toys, wire, bones, sticks and any other items, which can be thrown by the machine through the discharge opening.
- Do not pull the mower backwards, unless this is absolutely necessary. Always look down and behind you, before and while moving backwards. Use extreme caution when reversing or pulling the lawnmower towards you.
- Before operating the mower, make sure that all protective screens, the grass catcher and other protective devices are properly installed. Never operate the lawnmower with defective guards, or without safety devices, for example deflectors and/or grass catchers in place.
- Observe the instructions of the manufacturer, for proper operation and installation of accessories. Only those accessories that have been approved by the manufacturer may be used.
- Make sure that the blade(s) of the mower is (are) not rotating, before crossing gravel drives, walkways or roads.

- Stop the engine (motor) and wait until the blade comes to a complete stop, before removing the grass catcher.
- Mowing should only be done during daylight or under good artificial lighting.
- Do not operate the machine while being tired, ill or under the influence of alcohol or drugs.
- Use slip-resistant shoes as well as suitable clothing. Never operate the mower in wet grass, where feasible. Always be sure of your footing: Keep a firm hold on the handle and walk; never run.
- Before starting the engine (motor), disengage all blade and self-propelling mechanism or drive clutch on mowers so equipped.
- If the mower should start to vibrate abnormally, stop the engine (motor) and check immediately for the cause. Vibration is generally a warning of trouble.
- Keep hands and feet away from the enclosure.
- Worn parts should be referred to our repair shop to be replaced. If necessary, contact the service specified address.
- Before using the machine, inspect the machine by visual to determine whether the cutting, fastening bolts and the entire mower deck worn or damaged. To avoid an imbalance may be, replace worn out or damaged cutting attachment bolts sets.
- Secure the unit during transport to prevent loss of fuel, damage or injury.
- Warning! Do not use the unit in the event of thunderstorm.
- Follow the maintenance schedule in this manual. Poor maintenance may lead to hazard risk of fire, unit damage or personal injury.
- Only use original spare parts from manufacturer. Unapproved parts may lead to unit damage and unforeseeable risk.

II. SLOPE OPERATION

- Slopes are a major factor related to slip and fall accidents, which can result in severe injury. All slopes require extra caution. If you feel uneasy on a slope, do not mow it.

DO:

- Mow across the face of slopes: never up and down. Exercise extreme caution when changing direction on slopes.
- Remove obstacles such as rocks, tree limbs, etc.
- Watch for holes, ruts, or bumps. Tall grass can hide obstacles.

DO NOT:

- Do not trim near drop-offs, ditches or embankments. The operator could lose footing or balance.
- Do not trim excessively steep slopes.
- Do not mow on wet grass. Reduced footing could cause slipping.

III. CHILDREN

Tragic accidents can occur if the operator is not alert to the presence of children. Children are often attracted to the machine and the mowing activity. Never assume that children will remain where you last saw them.

- Keep children out of the trimming area and under the watchful care of another responsible adult.
- Be alert and turn machine off if children enter the area.
- Before and while walking backwards, look behind and down for small children.
- Never allow children to operate the machine.
- Use extra care when approaching blind corners, shrubs, trees, or other objects that may obscure vision.

IV. GENERAL INSTRUCTIONS FOR WORKING WITH YOUR LAWNMOWER

- **WARNING:** petrol is highly flammable. Use extra care in handling gasoline and other fuels. They are flammable and vapors are explosive.
 - Store fuel in containers specially designed for this purpose; Use only an approved fuel container.
 - Refuel outdoors only and do not smoke while refueling; Never refuel the machine indoors.
 - Never store the machine or fuel container near an open flame, such as a water heater
 - Add fuel before starting the engine. Never remove the cap of the fuel tank or add petrol while the engine is running or when the engine is hot; Allow the engine to cool before refuelling.
 - If petrol is spilled, do not attempt to start the engine but move the machine away from the area of spillage and avoid creating any source of ignition until petrol vapors have dissipated.
 - Replace all fuel tanks and container caps securely;
 - Do not smoke in the neighbourhood of the mower.
- Replace faulty silencers
- Clean up any oil or fuel spills.
- Do not start the engine when standing in front of the discharge chute.
- Do not put hands or feet near or under rotating parts. Keep clear of the discharge opening at all times.
- Do not operate the engine in a confined space where dangerous carbon monoxide fumes can collect; Walk never run.
- Always be sure of your footing on slopes.
- Do not change the engine governor settings or over-speed the engine;
- Never make adjustments or repairs with the engine (motor) running. Disconnect the spark plug wire, and keep the wire away from the plug to prevent accidental starting.
- Check regularly that nuts and bolts, especially blade attachment bolts, are fastened tightly and keep the equipment in a good condition.
- Never disable or tamper with safety systems or features. Check all starting interlocks and operator presence controls regularly and ensure they are properly functioning.
- Make sure that grass, leaves or other debris does

not collect in the mower; check regularly and remove such residues to blocking.

- Stop and inspect your lawnmower if you strike any object. Repair, if necessary, before restarting.
- Never attempt to make wheel height adjustments while the engine (motor) is running.
- Grass catcher components are subject to wear, damage and deterioration, which could expose moving parts or allow objects to be ejected. Frequently check these components and, if necessary, replace damaged components with parts recommended by the manufacturer.
- Mower blades are sharp and can cause injuries. Wrap the blade(s) or wear gloves when handling them, and use extra caution during blade maintenance.
- Be especially careful in case you reverse the mower or going to use the machine.
- Stop the blade(s) if the lawnmower has to be tilted for transportation when crossing surfaces other than grass, and when transporting the lawnmower to and from the area to be mowed.
- Start the engine or switch on the motor carefully according to instructions and with feet well away from the blades.
- Do not tilt the lawnmower when starting the engine or switching on the motor, except if the lawnmower has to be tilted for starting. In this case, do not tilt it more than absolutely necessary and lift only the part which is away from the operator.
- Never pick up or carry a lawnmower while the engine is running.
- Stop the engine and disconnect the spark plug wire.
 - Before clearing blockages or unclogging chute.
 - before checking, cleaning or working on the lawnmower.
 - after striking a foreign object. Inspect the lawnmower for damage and make repairs before re-starting and operating the lawnmower;
- If lawnmower starts to vibrate abnormally (check immediately).
- Stop the engine:
 - whenever you leave the lawnmower.
 - before re-fuelling.
- Reduce the throttle setting during engine shut down and, if the engine is provided with a shut-off valve, turn the fuel off at the conclusion of mowing;
- Allow the engine to cool before storing in any enclosure
- Never store the equipment with petrol in the tank inside a building where fumes can reach an open flame or spark. To reduce the fire hazard, keep the engine, silencer, battery compartment and petrol storage area free of grass, leaves, or excessive grease.
- Check the grass catcher frequently for wear or deterioration
- If the fuel tank has to be drained, this should be done outdoors.

PRODUCT SPECIFICATIONS

MODEL	WB 454HB WB 456HKL WB 456HC WB 456SC WB 456SE WB 456SE E	WB 454SB WB 455SKL WB 455SC WB 456HC WB 456SE WB 456SE V E	WB 454HB-3IN1 WB 456HKL-3IN1 WB 456HC-3IN1 WB 456SC-3IN1 WB 456SE-3IN1 WB 456SE V E-3IN1	WB 454SB-3IN1 WB 456HKL-3IN1 WB 456HC-3IN1 WB 456SC-3IN1 WB 456SE-3IN1 WB 456SE V E-3IN1	WB 456SKL V-3IN1 WB 456SKL-L4J WB 456SC V-3IN1 WB 456SE V E-3IN1	WB 454HB-2IN1 WB 455HC-2IN1	WB386HC-M WB386HKL-M	WB466SC-M WB466SKL-L4J WB466SC-M-DOV WB466SK V-M	WB 506SB-DOV	WB 506SB-DOV	
Nominal power	1.94kW 2.3kW 2.17kW 2.6kW 2.6kW	1.94kW 2.3kW 2.17kW 2.6kW 2.6kW	1.94kW 2.3kW 2.17kW 2.6kW 2.6kW	1.94kW 2.3kW 2.17kW 2.6kW 2.6kW	1.94kW 2.3kW 2.17kW 2.6kW 2.6kW	1.94kW 2.3kW 2.17kW 2.6kW 2.6kW	1.94kW 2.3kW 2.17kW 2.6kW 2.6kW	2.6kW 2.3kW 2.7kW 2.45kW	2.7kW	2.7kW	
Cutting Width	450mm	450mm	450mm	450mm	450mm	450mm	382mm	460mm	492mm	492mm	
Motor	Briggs&Stratton 500E KOHLER XT675 LONCIN 1P65FE LONCIN 1P65FE-2 LONCIN 1P65FE-2	Briggs&Stratton 500E KOHLER XT675 LONCIN 1P65FE LONCIN 1P65FE-2 LONCIN 1P65FE-2	Briggs&Stratton 500E KOHLER XT675 LONCIN 1P65FE LONCIN 1P65FE-2 LONCIN 1P65FE-2	Briggs&Stratton 500E KOHLER XT675 LONCIN 1P65FE LONCIN 1P65FE-2 LONCIN 1P65FE-2	Briggs&Stratton 500E KOHLER XT675 LONCIN 1P65FE LONCIN 1P65FE-2 LONCIN 1P65FE-2	KOHLER XT675 LONCIN 1P65FE LONCIN 1P65FE-2 LONCIN 1P65FE-2	Briggs&Stratton 500E LONCIN 1P65FE LONCIN 1P65FE	LONCIN 1P65FE-2 KOHLER XT675	LONCIN 1P65FE-2 KOHLER XT675 KAWASAKI FJ180V	Briggs&Stratton 750EX DOV 750EX DOV	Briggs&Stratton 750EX DOV
Moving type	Hand propelled Hand propelled Self-propelled	Self-propelled	Hand propelled	Self-propelled	Self-propelled	Hand propelled	Hand propelled	Self-propelled	Hand propelled	Self-propelled	
Drive speed	/	/ / Adjustable	/	/	Adjustable /	/	/	/ / Adjustable	/	/	
Cutting Height	20-70mm	20-70mm	20-70mm	20-70mm	20-70mm	15-75mm	15-54mm	18-65mm	20-70mm	20-70mm	
Cutting Height adjustment	8	8	8	8	8	6	6	7	8	8	
Grass bag capacity	50L	50L	50L	50L	50L	/	/	/	60L	60L	
Maximum operating engine speed	2800 min ⁻¹	2800 min ⁻¹	2800 min ⁻¹	2800 min ⁻¹	2800 min ⁻¹	2800 min ⁻¹	2800 min ⁻¹	2800 min ⁻¹	2800 min ⁻¹	2800 min ⁻¹	
Net Weight	29.6kg 35.6kg 30.6kg 30.6kg 39.3kg	32kg 38kg 33kg 33kg 40.5kg	30kg 36kg 31kg 31kg 31kg	33.4kg 38.5kg 34.5kg 34.5kg 34.5kg	40.5kg 36.5kg 36.5kg 36.5kg 36.5kg	25kg	28.3kg 29kg	40.4kg 45kg 40.2kg	43.4kg	45.2kg	
Guaranteed Noise power level (L _{WA} (A)) (2000/145C)	96dB(A)	96dB(A)	96dB(A)	96dB(A)	96dB(A)	96 dB(A)	96 dB(A)	96 dB(A)	96dB(A)	96dB(A)	
L _{WA} at operator's position	83.1dB(A) 84.5dB(A) 82.4dB(A)	83.1dB(A) 85.4dB(A) 84.5dB(A) 84.5dB(A) 82.1dB(A)	81.9dB(A) 86.3dB(A) 86.3dB(A) 84.5dB(A) 82.7dB(A)	81.9dB(A) 86.3dB(A) 84.5dB(A) 86.3dB(A) 82.7dB(A)	86.3dB(A) 82.1dB(A) 83.1dB(A)	84.2dB(A) 81.9dB(A)	78.4dB(A) 81.9dB(A)	79.3dB(A) 82.7dB(A) 83.7dB(A)	83.7dB(A)	84.5dB(A)	
K _{WA}	2.5dB(A)	2.5dB(A)	2.5dB(A)	2.5dB(A)	2.5dB(A)	2.5dB(A)	2.5dB(A)	2.5dB(A)	2.5dB(A)	2.5dB(A)	
Vibration	6.36m/s ² 7.13m/s ² 6.87m/s ²	6.36m/s ² 7.13m/s ² 6.87m/s ²	6.36m/s ² 5.8m/s ² 7.13m/s ² 6.73m/s ²	6.36m/s ² 5.8m/s ² 7.13m/s ² 6.73m/s ²	5.8m/s ² 5.84m/s ² 5.84m/s ² 7.4m/s ²	11.6m/s ² 4.4m/s ²	10.6m/s ² 12.5m/s ²	10.4m/s ² 1.13m/s ² 9.1m/s ² 8.8m/s ²	9.41m/s ²	6.2m/s ²	
K	1.5m/s ²	1.5m/s ²	1.5m/s ²	1.5m/s ²	1.5m/s ²	1.5m/s ²	1.5m/s ²	1.5m/s ²	1.5m/s ²	1.5m/s ²	
Blade type	4510403010	4510403010	4510403010	4510403010	4510403010	4510405010	GM38A000000030	GM46A000000010	5020405010	5020405010	
MODEL	WB506SKL-1-DOV WB506SKL V-3IN1-DOV	WB506HKL WB506HC	WB506SKL WB506SC WB506SC E WB506SC V E	WB506SKL-3IN1 WB506SC-3IN1 WB506SC V-3IN1 WB506SC V E-3IN1	WB 536SB-DOV WB 536SKL WB 536SKL	WB536SK-3IN1 WB536SKL-3IN1	WB536SK V-3IN1 WB536SKL V-3IN1	WB537HCU WB537SLC WB537SLC V-3IN1	WB536SB-3IN1-DOV WB536SB V-3IN1-DOV	WB536SKL-M WB536SB-M-DOV WB536SK V-M WB537SC-M	
Nominal power	2.7kW	2.3kW 2.6kW 2.6kW	2.3kW 2.6kW 2.6kW	2.3kW 2.6kW 2.6kW	2.7kW 2.9kW	3.1kW 3.45kW	2.8kW 2.8kW	3.1kW 3.45kW	2.7kW	2.7kW 3.45kW 3.4kW	
Cutting Width	492mm	492mm	492mm	492mm	530mm	530mm	530mm	530mm	530mm	530mm	
Motor	Briggs&Stratton 750EX DOV 750EX DOV	KOHLER XT675 LONCIN 1P65FE-2	KOHLER XT675 LONCIN 1P65FE-2 LONCIN 1P65FE-2	KOHLER XT675 LONCIN 1P65FE-2 LONCIN 1P65FE-2	Briggs&Stratton 750EX DOV KAWASAKI FJ180V KOHLER XT-775	KAWASAKI FJ180V KOHLER XT-775	KAWASAKI FJ180V KOHLER XT-775	Loncin P70FC	Briggs&Stratton 750EX DOV 750EX DOV	KOHLER XT-775 Briggs&Stratton 750EX DOV KAWASAKI FJ180V Loncin P70FC	
Moving type	Self-propelled	Hand propelled	Self-propelled	Self-propelled	Self-propelled	Self-propelled	Self-propelled	Hand propelled Self-propelled	Self-propelled	Self-propelled	
Drive speed	/ Adjustable	/	/ / Adjustable	Adjustable /	/	/	/	Adjustable /	Adjustable	Adjustable /	
Cutting Height	20-70mm	20-70mm	20-70mm	20-70mm	25-80mm	25-80mm	25-80mm	25-80mm 1144mm 25-80mm	25-80mm	15-67mm	
Cutting Height adjustment	8	8	8	8	8	8	8	7 8	8	8	
Grass bag capacity	60L	60L	60L	60L	70L	70L	70L	70L	70L	/	
Maximum operating engine speed	2800 min ⁻¹	2800 min ⁻¹	2800 min ⁻¹	2800 min ⁻¹	2800 min ⁻¹	2800 min ⁻¹	2800 min ⁻¹	2800 min ⁻¹	2800 min ⁻¹	2800 min ⁻¹	
Net Weight	40kg 42kg	38.3kg 37kg	51kg 43kg 42.7kg 44kg	47kg 42.3kg 44kg	44.2kg	48.7kg 47.7kg 47.3kg	50.7kg 50.3kg	33.5kg 47kg 50kg	46.5kg 48.5kg	47kg 55kg 49.2kg 47.4kg	
Guaranteed Noise power level (L _{WA} (A)) (2000/145C)	96dB(A)	96dB(A)	96dB(A)	96dB(A)	98dB(A)	98dB(A)	98dB(A)	98dB(A)	98dB(A)	98dB(A)	
L _{WA} at operator's position	84.5dB(A) 83.4dB(A)	85.6dB(A) 84.1dB(A)	85.6dB(A) 84.1dB(A) 84.7dB(A) 83.8dB(A)	86dB(A) 84.1dB(A) 84.1dB(A) 85.3dB(A)	84.0 dB(A) 84.1dB(A)	85.2dB(A) 84.1dB(A)	84.1dB(A)	82.6dB(A) 79.9dB(A) 79.9dB(A)	86.2dB(A) 85.1dB(A)	80.1dB(A) 85.5dB(A) 79.9dB(A) 83.5dB(A)	
K _{WA}	2.5dB(A)	2.5dB(A)	2.5dB(A)	2.5dB(A)	2.5dB(A)	2.5dB(A)	2.5dB(A)	2.5dB(A)	2.5dB(A)	2.5dB(A)	
Vibration	6.1m/s ² 5.8m/s ²	5.2m/s ²	5.2m/s ² 9.98m/s ² 6.7m/s ² 7.3m/s ²	6.8m/s ² 9.93m/s ² 9.84m/s ² 8.5m/s ²	9.27m/s ² 9.84m/s ² 8.5m/s ²	9.84m/s ² 9.84m/s ² 8.5m/s ²	9.84m/s ² 8.5m/s ²	7.48m/s ² 8.2m/s ² 8.2m/s ²	8.6m/s ²	2.86m/s ² 2.9m/s ² 2.6m/s ² 1.5m/s ²	
K	1.5m/s ²	1.5m/s ²	1.5m/s ²	1.5m/s ²	1.5m/s ²	1.5m/s ²	1.5m/s ²	1.5m/s ²	1.5m/s ²	1.5m/s ²	
Blade type	5020405040 5020405010	5020405010	5020405010	5020405040 5020405010	5310403010	5310403010	5310403010	WB2100000008 5310403010 5310403010	5310403010	GM53A000000110	

Note: The lawnmowers' net weight is depending on the different model of engine.

These specifications are provided as a reference, these are familiarized with the mower. We reserve the right to make technical changes and other without advance notification. It is possible that some details in this manual does not coincide completely with your machine.



WARNING: Engine exhaust gases and some of its constituents, as well as certain other vehicle components contain or emit chemicals, which are known to cause cancer, possible birth defects or harm to the reproductive organs.

SERIAL NUMBER _____

DATE OF PURCHASE _____

THE MODEL AND SERIAL NUMBERS WILL BE FOUND ON A DECAL ATTACHED TO THE REAR OF THE LAWNMOWER HOUSING.
YOU SHOULD RECORD BOTH SERIAL NUMBER AND DATE OF PURCHASE AND KEEP IN A SAFE PLACE FOR FUTURE REFERENCE.

We recommend that you write down the serial number and purchase date in your user manual, so that you will always have it at hand.

PROPER USE

The gasoline lawn mower is for private use in the home and garden suitable hobby. The mower may only be used for the maintenance of grass or lawns in the home and garden hobby can be used. Any application that is not listed in this guide is prohibited.

The above use and safety instructions must be strictly adhered to. The manufacturer assumes no liability for any damage caused by improper operation, improper use, misuse, unauthorized repairs or alterations performed.

CONGRATULATIONS on your purchase of a new lawnmower. It has been designed, engineered and manufactured to give you the best possible dependability and performance.

Should you experience any problem you cannot easily remedy, please contact the nearest authorized service center/department. We have competent, well-trained technicians and the proper tools to service or repair this lawnmower.

Please read and retain this manual. The instructions will enable you to assemble and maintain your lawn mower properly. Always observe the "SAFETY REGULATIONS"

MODEL 2in1 and 3in1 MOWER

Close the side discharge door. The grass will be cut multiple times under the cutting deck until small enough to be left on the lawn. The mulched grass will soon decay, becoming fertilizer for the promotion of better grass growth.

CUSTOMER RESPONSIBILITIES

- Read and observe the safety regulations contained in this manual.
- Follow a regular schedule for maintaining, caring for and using your lawnmower.

ASSEMBLY

Read these instructions and this manual in its entirety before you attempt to assemble or operate your new lawn mower.

IMPORTANT: THIS LAWN MOWER IS SHIPPED WITHOUT OIL OR GASOLINE IN THE ENGINE.

Your new lawn mower has been assembled at the factory with the exception of those parts left unass-

- Follow the instructions in the "Customer responsibilities" and "Storage" sections of this owner's manual.
- Remember that the operator is responsible for accidents with other persons or their property.



Residual risks

Even when the power tool is used as prescribed it is not possible to eliminate all residual risk factors. The following hazards may arise in connection with the power tool's construction and design:

1. Damage to lungs if an effective dust mask is not worn.
2. Damage to hearing if effective hearing protection is not worn.
3. Damages to health resulting from vibration emission if the power tool is being used over longer period of time or not adequately managed and properly maintained.

ACTIVATE LITHIUM BATTERY(if equipped)

Unopened lithium battery is in sleeping mode, you need to activate it before usage. Install the battery in corresponding charger for about 10 seconds, then the battery is activated and working properly. (See engine manual)

After mowing work, please checking the power level indicator of lithium battery, if less than two lights, charge it until at least two lights.

In sleeping mode, the battery's power storage time can be significantly extended.

Return an activated lithium battery to sleeping mode:

- Press and hold the power level indicator button. The LED light will light up for about 4 to 5 seconds, and then turn off. After about 15 seconds, power indicator lights up again.



- Release the button, and then LED light turns off one by one. Now the battery is in sleeping mode.

embled for shipping purposes. All parts such as nuts, washers, bolts, etc., necessary to complete the assembly have been placed in the parts bag. To ensure safe and proper operation of your lawn mower, All parts and hardware you assemble must be tightened securely. Use the correct tools as necessary to ensure proper tightness.

I. TO REMOVE LAWN MOWER FROM CARTON

- Remove loose parts included with mower.
- Cut down two end corners of carton and lay end panel down flat.
- Remove all packing materials except padding between upper and lower handle and padding holding operator presence control bar to upper handle.
- Roll lawn mower out of carton and check carton thoroughly for additional loose parts.

II. HOW TO SET UP YOUR LAWN MOWER

IMPORTANT: UNFOLD HANDLE CAREFULLY SO AS NOT TO PINCH OR DAMAGE CONTROL CABLES.

- Lift and unfold upper handle to desired height and pull two levers on both sides to lock upper handle. Refer to Service and Adjustments section.

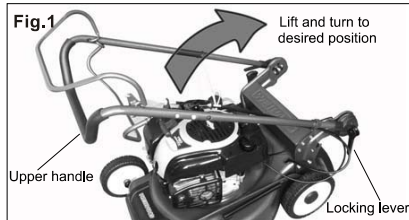

- Remove any packing material from around control bar.
- CAUTION:** Unfold the handle carefully to avoid pinching and damaging the control cables.
- Your handles may be adjusted for your mowing comfort. Refer to Service and Adjustments section of this manual.(except 2in1 mower)

CAUTION: Wear protective gloves during operation of setting up your mower.

III. ASSEMBLE ENGINE STARTER KNOB

- Press down engine brake handle by left hand, and meanwhile pull the knob of starter rope back to the hook ring on upper handle, assemble. The rope into the hook ring through the opening of hook ring .
- Always keep starter rope in hook ring during all mowing work.

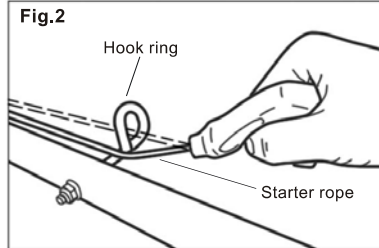

WARNING: The safety position of starting engine is at the back of upper handle. Users must keep the rope always in the middle of the hook ring during starting engine and mowing work. It is danger to starting engine away from the safety position, which will lead to the risk of feet hurting.

OPERATION

These symbols may appear on your lawn mower or in literature supplied with the product. Learn and understand their meaning.



DRIVE CLUTCH LEVER-used to engage power-propelled forward motion lawn mower.

THROTTLE CONTROL-used for starting the engine and allows you to select either fast or slow engine speed.

STARTER HANDLE-used for starting the engine.

MULCHER PLUG-located at the discharge opening, must be removed when converting to bagging operation. (For 3in1 mower)

Fig.3



MULCHER DOOR-allows conversion to discharge or bagging operation.(for 3in1/2in1 mower)

OPERATOR PRESENCE CONTROL LEVER-must be held down to the handle to start the engine. Release to stop the engine.

WARNING: The operation of any lawn mower can result in foreign objects thrown into the eyes, which can result in severe eye damage. Always wear safety glasses or eye Shields while operating your lawn mower or performing any adjustments or repairs. We recommend wide vision safety mask over spectacles or standard safety glasses.

ENGINE CONTROL ZONE

● Your lawn mower is equipped with an operator presence control lever which requires the operator to be positioned behind the lawn mower handle to start and operate the lawn mower.

TO OPERATE DRIVE SYSTEM(See Fig.5)

- To start forward motion, lift drive control lever up to handle.
- To stop forward motion, release drive control lever.

IMPORTANT: ALWAYS KEEP DRIVE CONTROL FULLY ENGAGED AGAINST HANDLE WHEN IN USE. Power propelled:

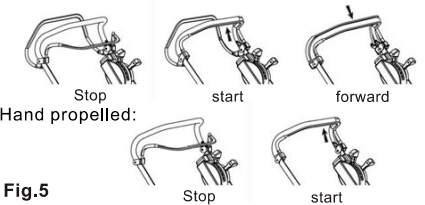

HOW TO USE YOUR LAWN MOWER

ENGINE SPEED

A throttle located on the side of the upper handle controls the engine speed. Fast position is for normal cutting, trimming and better grass bagging. Slow position is for light cutting, trimming and fuel economy.

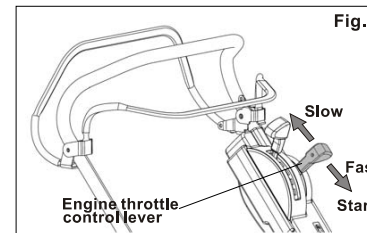

ENGAGE THE BLADE-CLUTCH (See Fig.6) only for machines with BBC

NOTE:The blade-brake-clutch should be engaged only when the engine is in maximum throttle state.

1. For safety, the blade-clutch-lever can not be engaged directly after releasing. Push the lever forward until it make a 'click' sound, and then you can engaged the clutch again.

2. Press the blade-clutch-lever close to the handle-bar completely to engage blade.
3. Release the lever about 2" away from the handle-bar, until the lever make a 'click' sound. And then re-press the lever and hold it together with the handlebar.
4. Release the blade-clutch-lever completely to dis-engage and stop the blade.

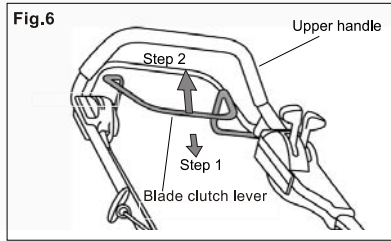

ADJUSTING THE DRIVE SPEED (FOR SPEED ADJUSTABLE MODEL)(See Fig.7)

NOTE: The speed may only be adjusted when the engine is running in order to avoid damage!

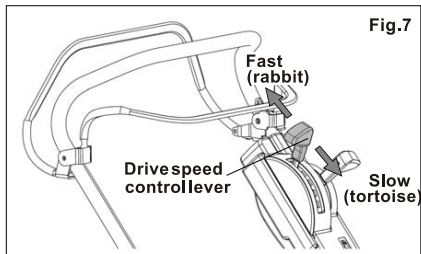

- The driving speed can be continuously adjusted by using the adjustment lever mounted on the upper hand.
- First press the lever slightly downwards and adjust to the desired speed. The lever automatically clicks back into the nearest new position.
- Position "rabbit" =fast(max. speed)
- Position "tortoise" =slow (min. speed)

ADJUSTING THE CUTTING HEIGHT (See Fig. 8)

- Never adjust the cutting height with the motor still running.
- The mower is adjusted to one cutting height upon delivery.
- All four wheels are adjusted by a single lever except the model 2in1. The 2in1 mower has two levers to adjust the front wheel and rear wheel individually.
- You can set the cutting height to the desired height to fit different terrain. Pull the lever out from the catch, move to the desired position and let it fall back into the catch.

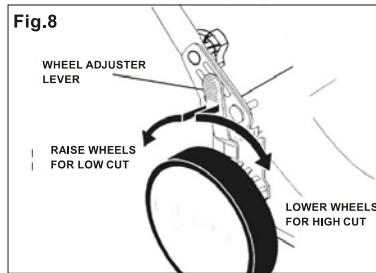

WARNING: The lawnmower can only be used on level lawns if the lowest cutting height is being used.

TO ATTACH GRASS CATCHER (except 2in1 mower)

1. Lift the rear door of the lawnmower, and then place the locating pins of grass catcher into hooks on both sides bracket.
2. The grass catcher is secured to the lawnmower housing when the rear door is lowered onto the grass catcher frame.

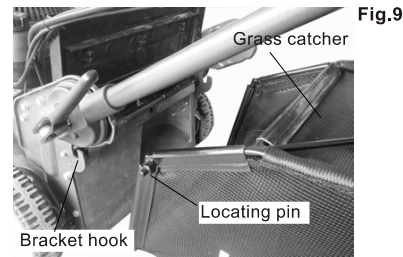

CAUTION: Do not run your lawnmower without clipping deflector or approved grass catcher in place. Never attempt to operate the mower with rear door removed or propped open.

TO CONVERT MOWER

Your lawnmower was shipped ready to be used as a mulcher. To convert to bagging or discharging:

REAR BAGGING (except 2in1 mower)

- Open rear door and remove mulcher plug. Store mulcher plug in a safe place.
- You can now install the grass catcher.
- To convert to mulching or discharging operation, install mulcher plug into rear discharge opening of mower.

SIDE DISCHARGING

- Mulcher plug must be installed into rear discharge opening of mower. (for 3in1 mower).
- Press down lever A to unlock and open mulcher door and install discharge deflector under the door as shown.

- Mower is now ready for discharging operation.
- To convert to mulching or bagging operation, discharge deflector must be removed and discharge guard must be closed.

REAR DISCHARGING

- Mulcher plug must be removed from rear discharge opening of mower.
- Mower is now ready for rear discharging operation.
- To convert to mulching or bagging operation, triangular brackets must be removed.

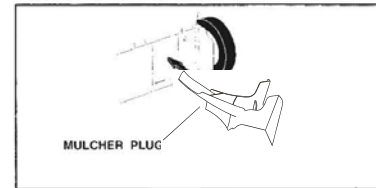
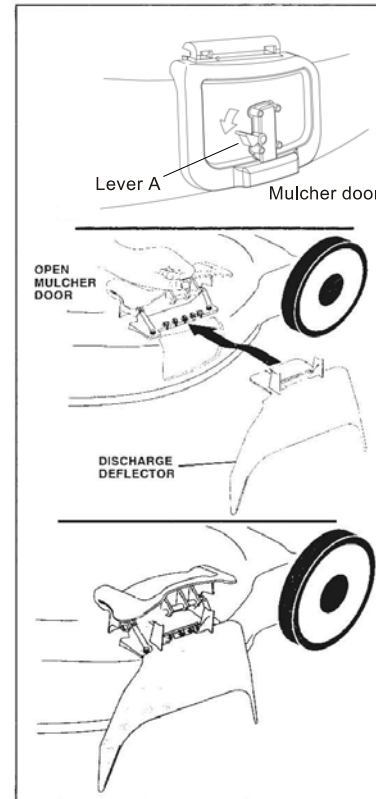

Fig.10



CAUTION: Do not run your lawn mower without rear door closed or approved grass catcher in place. Never attempt to operate the lawn mower with the rear door removed or propped open.

TO EMPTY GRASS CATCHER(except 2in1 mower)

1. Lift up on grass catcher using the frame handle.
2. Remove grass catcher with clippings from under lawn mower handle.
3. Empty clippings from bag using both frame handle and bag handle.

NOTE: Do not drag the bag when emptying; it will cause unnecessary wear.

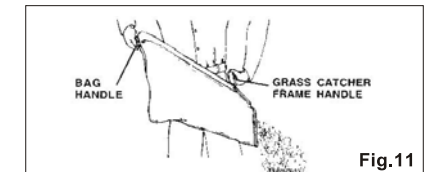

Fig.11

CAUTION: During operation of emptying clippings from grass catcher, please wear protective gloves to prevent environmental influence on your skin.

BEFORE STARTING ENGINE

ADD OIL

Your lawnmower is shipped without oil in the engine. Engine holds approximately 0.6L refer to engine manufacturers specifications in engine hand book. For type and grade of oil to use, see "ENGINE" in Customer Responsibilities section of this manual.

1. Be sure lawnmower is level and area around oil fill is clean.
2. Remove engine oil cap and fill to the full line on the dipstick. Pour oil slowly. Do not over fill.

- NOTE: Allow oil to settle down into engine for accurate reading. To read proper level, tighten engine oil cap, then remove it to read the dipstick.**
3. Reinstall engine oil cap and tighten.
 - Check oil level before each use. Add oil if needed. Fill to full line on dipstick.
 - Change the oil after every 25 hours of operation or each season. You may need to change the oil more often under dusty, dirty conditions.

ADD GASOLINE

NOTE: Before filling fuel tank, remove and discard the debris plug that is inside the tank.

Fill fuel tank. Use fresh, clean, regular unleaded gasoline with a minimum of 87 octants. Do not mix oil with gasoline. Purchase fuel in quantities that can be used within 30 days to assure fuel freshness.



WARNING: Experience indicates that alcohol blended fuels (called gasohol or using ethanol or methanol) can attract moisture which leads to separation and formation of acids during storage. Acidic gas can damage the fuel system of an engine while in storage. To avoid engine problems, the fuel system should be emptied before storage of 30 days or longer. Drain the gas tank, start the engine and let it run until the fuel lines and carburetor are empty. Use fresh fuel next season. See storage instructions for additional information. Never use engine or carburetor cleaner products in the fuel tank or permanent damage may occur.



CAUTION: Fill to bottom of gas tank filler neck. Do not overfill. Wipe off any spilled oil or fuel. Do not store, spill or use gasoline near an open flame.

TO START ENGINE

NOTE: Due to protective coatings on the engine, a small amount of smoke may be present during the initial use of the product and should be considered normal.

1. To start a cold engine, push primer three times before trying to start. Use a firm push. This step is not usually necessary when starting an engine, which has already run for a few minutes.

2. Move throttle control lever to fast position.

3. Hold operate presence control bar down to the handle and pull starter handle quickly. Do not allow starter rope to snap back.

4. If the mower is equipped with an electric-start switch, hold operate presence control bar down to the handle and start the engine by 2 steps: 1) In sert red key "A" into switch box; 2) Press down red button "B".

Note: Remember removing the key from switch box before you leave the unit.

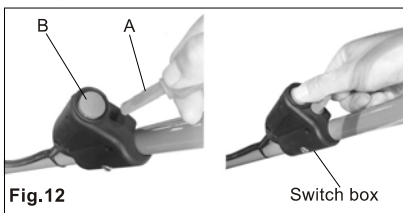

Fig.12



CAUTION: If the engine fails to start in 30 second after repeated starting operation by pulling the starter knob, please stop your operation and check the causes. See trouble shooting.

TO STOP ENGINE

● To stop engine, release operator presence control Bar.

NOTE: In cooler weather it may be necessary to repeat priming steps. In warmer weather over priming may cause flooding and engine will not start. If you do flood engine, wait a few minutes before attempting to start and do not repeat priming steps.

MOWING TIPS

● Under certain conditions, such as very tall grass, it may be necessary to raise the height of cut to reduce pushing effort and to keep from overloading the engine and leaving clumps of grass clippings. It may also be necessary to reduce ground speed and /or run the lawn mower over the area a second time.

● For extremely heavy cutting, reduce the width of cut by overlapping previously cut path and mow slowly.

● For better grass bagging and most cutting conditions, the engine speed should be set in the fast position.

● Pores in cloth grass catchers can become filled with dirt and dust with use and catchers will collect less grass. To prevent this, regularly hose catcher off with water and let dry before using.

● Keep top of engine around starter clear and clean of grass clippings and chaff. This will help engine air flow and extend engine life.



IMPORTANT: FOR BEST PERFORMANCE, KEEP MOWER HOUSING FREE OF BUILT-UP GRASS AND TRASH. SEE "CLEANING" IN CUSTOMER RESPONSIBILITIES SECTION OF THIS MANUAL.

MULCHING MOWING TIPS (for 3in1/2in1 mower) .

● The special mulching blade will re-cut the grass clippings many times and reduce them in size so that as they fall onto the lawn they will disperse into the grass and not be noticed. Also, the mulched grass will biodegrade quickly to provide nutrients for the lawn. Always mulch with your highest engine (blade) speed, as this will provide the best re-cutting action of the blades.

● Avoid cutting your lawn when it is wet. Wet grass tends to form clumps and interferes with the mulching action. The best time to mow your lawn is the early afternoon. At this time the grass has dried and the newly cut area will not be exposed to the direct sun.

● For best results, adjust the lawn mower cutting height so that the lawn mower cuts off only the top one-third of the grass blades. If the lawn is overgrown it will be necessary to raise the height of cut to reduce pushing effort and to keep from overloading the engine and leaving clumps of mulched grass. For extremely heavy mulching, reduce your width of cut by overlapping previously cut path and mow slowly.

● Certain types of grass and grass conditions may require that an area be mulched a second time to completely hide the clippings. When doing a second cut, mow across or perpendicular to the first cut path.

● Change your cutting pattern from week to week. Mow north to south one week then change to east to west the next week. This will help prevent matting and graining of the lawn.

CUSTOMER RESPONSIBILITIES

MAINTENANCE SCHEDULE

FILL IN DATES AS YOU COMPLETE REGULAR SERVICE		BEFORE EACH USE	AFTER EACH USE	EVERY 10 HOURS	EVERY 25HOURS OR EVERY SEASON	BEFORE STORAGE	SERVICE DATES
M O W E R	Check for loose fasteners	✓				✓	
	Clean/Inspect Grass Catcher (If Equipped)	✓	✓			✓	
	Clean Lawnmower		✓			✓	
	Clean Under Drive Cover (Power-Propelled Mowers)			✓		✓	
	Check/Sharpen/Replace Blade				✓3		
Lubrication Chart					✓	✓	
E N G I N E	Change Engine Oil				✓		
	Check Engine Oil Level	✓1, 2					
	Clean Air Filter			✓2			
	Inspect Muffler				✓		
	Clean or replace Spark Plug				✓		
Replace Air Filter Paper Cartridge					✓		

1. Change more often when operating under a heavy load or in high ambient temperatures.
2. Service more often when operating in dirty or dusty conditions.
3. Replace blades more often when mowing in sandy soil.

GENERAL RECOMMENDATIONS

The warranty on this lawn mower does not cover items that have been subjected to operate or abuse or negligence. To receive full value from the warranty, operator must maintain mower as instructed in this manual. Some adjustments will need to be made periodically to properly maintain your unit. All adjustments in the Service and Adjustments section of this manual should be checked at least once each season.

● Once a year, replace the spark plug, clean or replace air filter element and check blade for wear. A new spark plug and clean/new air filter element assures proper air-fuel mixture and helps your engine run better and last longer.

● Follow the maintenance schedule in this manual.



WARNING: MAKE SURE DOING ALL OPERATIONS WHEN THE ENGINE STOPPED.

BEFORE EACH USE

1. Check engine oil level.
2. Check for loose fasteners.

LUBRICATION

Keep unit well lubricated.

LAWN MOWER

Always observe safety rules when performing any maintenance.

TIRE

- Keep tires free of gasoline, oil, or insect control chemicals which can harm rubber.
- Avoid stumps, stones, deep ruts, sharp objects and other hazards that may cause tire damage.

BLADE CARE

For best results, mower blade must be kept sharp. Replace bent or damaged blades.

TO REMOVE BLADE

1. Disconnect spark plug wire from spark plug and place wire where it cannot come in contact with spark plug.
2. Turn lawn mower on its side. Make sure air filter and carburetor are up.
3. Use a woodblock between blade and mower housing to prevent blade from turning when removing blade bolt.

NOTE: Protect your hands with gloves and/or wrap blade with heavy cloth.

4. Remove blade bolt by turning counter-clockwise.
5. Remove blade and attaching hardware.

NOTE: Remove the blade adapter and check the key inside hub of blade adapter. The key must be in good condition to work properly. Replace adapter if damaged.

Fig.13

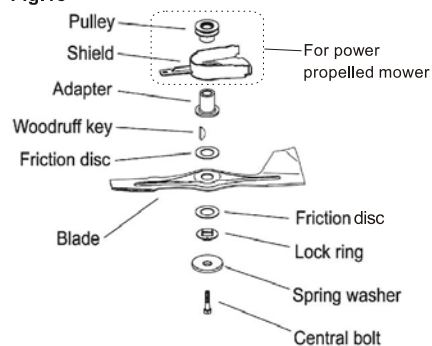

Belt drive models

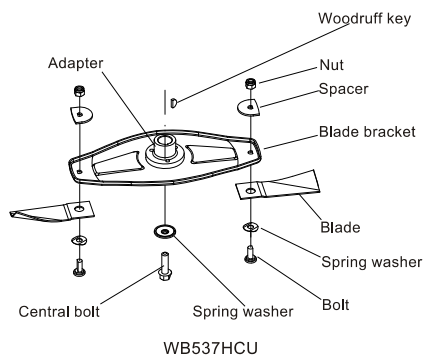

WB537HCU

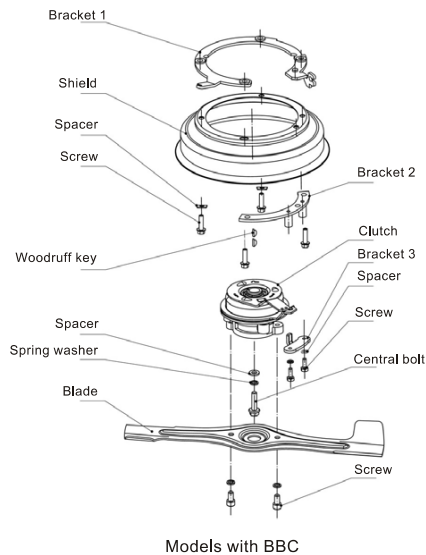

Models with BBC

TO REPLACE BLADE

1. Position the blade adapter on the engine crankshaft. Be sure key in adapter and crankshaft keyway are aligned.
2. Be sure the trailing edge of blade (opposite sharp edge) is up toward the engine.
3. Install the blade bolt with the Belleville spring into blade adapter and crankshaft.
4. Use block of wood between blade and lawn mower housing and tighten the blade bolt, turning clockwise.

IMPORTANT: BLADE BOLT IS GRADE 10.9 HEAT TREATED.

TO SHARPEN BLADE

NOTE: We do not recommend sharpening blade but if you do, be sure the blade is balanced.

Care should be taken to keep the blade balanced. An unbalanced blade will cause eventual damage to lawn mower or engine.

- The blade can be sharpened with a file or on a grinding wheel. Do not attempt to sharpen while on the mower.
- To check blade balance, drive a nail into a beam or wall. Leave about one inch of the straight nail exposed. Place center hole of blade over the head of the nail. If blade is balanced, it should remain in a horizontal position. If either ends of the blade moves downward, sharpen the heavy end until the blade is balanced.

GRASS CATCHER (except 2in1 mower)

- The grass catcher may be hosed with water, but must be dry when used.
- Check your grass catcher often for damage or deterioration. Through normal use it will wear. If catcher needs replacing, replace only with a manufacturer approved replacement catcher. Give the lawn mower model number when ordering.

DRIVE WHEELS (power propelled)

Check rear drive wheels each time you mow to be sure they move freely. The wheels not turning freely means trash, grass cuttings, etc. may be inside the drive wheel and dust cover area and must be cleaned out to free drive wheels. If necessary to clean the drive wheels, check both rear wheels.

1. Remove hubcaps, bolt, spring lock washer and washer.
2. Remove wheels from wheel adjuster axles.
3. Remove any trash or grass cutting from inside the dust cover, pinion and/or drive wheel gear teeth.

NOTE: The pinion gear, on both sides of the mower, are the same, however, they must be installed correctly. If installed incorrectly, the drive system will not work.

4. Place wheels back on adjuster axles.
5. Replace spring lock washer, washer, bolt and hub caps.

DRIVE BELT

If the belt must be replaced, please contact your service agent for details.

ENGINE

Read the Maintenance section of your engine manual.

LUBRICATION

Use only high quality detergent oil rated with API service classification SF-SJ. Select the oil's SAE viscosity grade according to your expected operating temperature.

LUBRICATION CHART

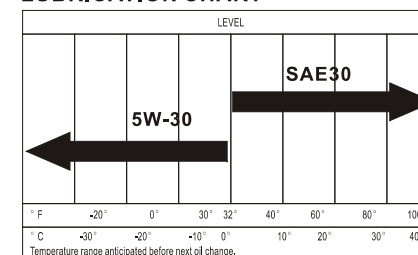

NOTE: Although multi-viscosity oils (5W30, 10W30 etc) improve starting in cold weather, these multi-viscosity oils will result in increased oil consumption when used above 32° F. Check your engine oil level more frequently to avoid possible engine damage from

running low on oil. Change the oil after every 25 hours of operation or at least once a year if the lawn mower is not used for 25 hours in one year. Check the crankcase oil level before starting the engine and after each five (5) hours of continuous use. Tighten oil plug securely each time you check the oil level.

TO CHANGE ENGINE OIL

NOTE: Before tipping lawn mower to drain oil, drain fuel tank by running engine until fuel tank is empty.

1. Disconnect spark plug wire from spark plug and place wire where it cannot come in contact with spark plug.
2. Remove engine oil cap; lay aside on a clean surface.
3. Tip lawn mower on its side as shown and drain oil into a suitable container. Rock lawn mower back and forth to remove any oil trapped inside of engine.
4. Return lawn mower to upright position. Wipe off any spilled oil from lawn mower or side of engine.
5. Fill engine with oil. See "ADD OIL" in the Operation section of this manual.
6. Reconnect spark plug wire to spark plug.

CAUTION: Disconnect spark plug wire from spark plug and place wire where it cannot come in contact with spark plug.

CLEANING

1. Clean the underside of your lawn mower by scraping to remove build-up of grass and trash.
2. Clean engine often to keep trash from accumulating. A clogged engine runs hotter and shortens engine life.
3. Keep finished surfaces and wheels free of all gasoline, oil, etc.
4. We do not recommend using a garden hose to clean lawn mower unless the electrical system, muffler, air filter and carburetor are covered to keep water out. Water in engine can result in shortened engine life.

AIR FILTER

Your engine will not run properly and may be damaged by using a dirty air filter. Clean the element after every 25 hours of operation, more often if lawn mower is used in very dusty, dirty conditions.

See the maintenance section of your engine manual.

MUFFLER

Inspect and replace corroded muffler as it could create a fire hazard and/or damage.

SPARK PLUG

Change your spark plug each year to make your engine start easier and run better. Set spark plug gap at .030 inch.

IMPORTANT: FOR BEST PERFORMANCE, KEEP MOWER HOUSING FREE OF BUILT-UP GRASS & TRASH. CLEAN THE UNDERSIDE OF YOUR MOWER AFTER EACH USE.

SERVICE AND ADJUSTMENTS

CAUTION: BEFORE YOU CHANGE SETTINGS OR MAINTENANCE TASKS:

1. Release drive control bar and the engine brake handle to stop the lawn mower.
2. Make sure the blade and all moving parts have stopped completely.
3. Disconnect cable from the sparkplug and place where it cannot come in contact with plug.
4. Make sure that all the nuts, bolts and screws are tightened and the device in a safe condition.
5. Let the mower to cool before using it in a closed area off.
6. In order to avoid the risk of fire, keep motor housing and ventilation openings free of grass, leaves and oil or fat.
7. Be sure to check the grass Fang's establishment of the wear and tear or loss of functionality.
8. Replace worn out or damaged parts for security reasons.

LAWN MOWER

TO ADJUST CUTTING HEIGHT

See "TO ADJUST CUTTING HEIGHT" in the Operation section of this manual.

TO ADJUST HANDLE (EXCEPT 2in1 MOWER)

The handle on your lawn mower has different height positions-adjust to height that suits you.

1. Loosen the 2 lever A on both sides.
2. Rotate upper handle to new catch desired.
3. Re-tighten lever A.

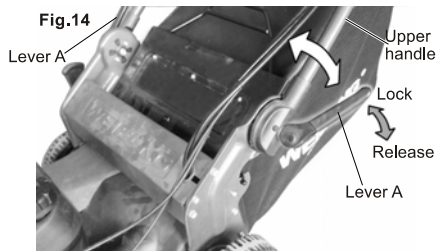

REAR DEFLECTOR

The rear deflector, attached between the rear wheels of your mower, is provided to minimize the possibility that objects will be thrown out of the rear of the mower into the operator's mowing position. If the deflector becomes damaged, it should be replaced.

ENGINE

ENGINE SPEED

Your engine speed has been factory set. Do not attempt to increase engine speed or it may result in personal injury. If you believe that the engine is running too fast or too slow, take your lawn mower to an authorized service center for repair and adjustment.

THROTTLE CONTROL

If it becomes necessary to adjust or replace the throttle control, see the adjustment section of your engine manual.

CARBURETOR

The carburetor has been preset at the factory and adjustment should not be necessary. However, minor adjustment may be required to compensate for differences in fuel, temperature, altitude or load.

- The air filter must be assembled to the carburetor when running engine.
- Best carburetor adjustment is obtained when fuel tank is 1/4 full.
- In order for the engine to run, the control bar must be held in the operating position. Therefore, an assistant will be required to hold the control bar in the operating position when making final adjustment to the carburetor.

See the Adjustment section of your engine manual for further instruction.

STORAGE

Immediately prepare your lawn mower for storage at the end of the season or if the unit will not be used for 30 days or more.

LAWN MOWER

When lawn mower is to be stored for a period of time, clean it thoroughly, remove all dirt, grease, leaves, etc. Store in a clean, dry area.

1. Clean entire lawn mower (See "CLEANING" in the Customer Responsibilities section of this manual)

2. Lubricate as shown in the Customer Responsibilities section of this manual.
3. Be sure that all nuts, bolts, screws, and pins are securely fastened. Inspect moving parts for damage, breakage and wear. Replace if necessary.
4. Touch up all rusted or chipped paint surfaces; sand lightly before painting.

HANDLE

You can fold your lawn mower handle for storage.

1. Loosen the two(2) handle knobs on sides of the upper handle and allow handle to fold down to the rear
2. Remove the two (2) handle knobs and screws at sides of the lower handle, and pivot entire handle assembly forward and allow it to rest on mower, and then reinstall screws and knobs to brackets.
3. When setting up your handle from the storage position, the lower handle will require manual locking into the mowing position.

ENGINE

FUEL SYSTEM

IMPORTANT: IT IS IMPORTANT TO PREVENT GUM DEPOSITS FROM FORMING IN ESSENTIAL SYSTEM PARTS SUCH AS CARBURETOR, FUEL FILTER, FUEL HOSE, OR TANK DURING STORAGE. ALSO, EXPERIENCE INDICATES THAT ALCOHOL BLENDED FUELS (CALLED GASOHOL OR USING ETHANOL OR METHANOL) CAN ATTRACT MOISTURE WHICH LEADS TO SEPARATION AND FORMATION OF ACIDS DURING STORAGE. ACIDIC GAS CAN DAMAGE THE FUEL SYSTEM OF AN ENGINE WHILE IN STORAGE.

- Drain the fuel tank.
- Start the engine and let it run until the fuel lines and carburetor are empty.
- Never use engine or carburetor cleaner products in the fuel tank or permanent damage may occur.
- Use fresh fuel next season.

NOTE: Fuel stabilizer is an acceptable alternative in minimizing the formation of fuel gum deposits during storage. Add stabilizer to gasoline in fuel tank or storage container. Always follow the mix ratio found

on stabilizer container. Run engine at least 10 minutes after adding stabilizer to allow the stabilizer to reach the carburetor. Do not drain the gas tank and carburetor if using fuel stabilizer.

Drain oil (with engine warm) and replace with clean engine oil. (See "ENGINE" in the CUSTOMER RESPONSIBILITIES section of this manual).

CYLINDER

1. Remove spark plug.
2. Pour one ounce (29ml) of oil through spark plug hole into cylinder.
3. Pull starter handle slowly a few times to distribute oil.
4. Replace with new spark plug.

OTHER

- Do not store gasoline from one season to another.
- Replace your gasoline can if your can starts to rust. Rust and /or dirt in your gasoline will cause problems.
- If possible, store your unit indoors and cover it to give protection from dust and dirt.
- Cover your unit with a suitable protective cover that does not retain moisture. Do not use plastic. Plastic cannot breathe which allows condensation to form and will cause your unit to rust.



IMPROTANT: NEVER COVER MOWER WHILE ENGINE AND EXHAUST AREAS ARE STILL WARM.



CAUTION: Never store the lawn mower with gasoline in the tank inside a building where fumes may reach an open flame or spark. Allow the engine to cool before storing in any enclosure.

TROUBLESHOOTING POINTS※

PROBLEM	CAUSE	CORRECTION
Does not start	1. Dirty air filter.	1. Clean/replace air filter.
	2. Out of fuel.	2. Fill fuel tank.
	3. Stale fuel.	3. Drain tank and refill with fresh clean fuel.
	4. Water in fuel.	4. Drain fuel tank and carburetor and refill tank with fresh gasoline.
	5. Spark plug wire is disconnected.	5. Connect wire to plug
	6. Bad spark plug.	6. Replace spark plug.
	7. Loose blade or broken blade adapter.	7. Tighten blade bolt or replace blade adapter.
	8. Control bar in released position.	8. Depress control bar to handle.
	9. Control bar defective.	9. Replace control bar.

Starter rope hard to pull	1.Engine flywheel brake is on when control bar is released.	1.Depress control bar to upper handle before pulling starter rope.
	2.Bent engine crankshaft.	2.Contact a qualified service center.
	3.Blade adapter broken.	3.Replace blade adapter.
	4.Blade dragging in grass.	4.Move lawn mower to cut grass or to hard surface.
Grass catcher not filling (If required)	1.Cutting height too low.	1.Raise cutting height.
	2.Lift on blade worn off.	2.Replace blade.
	3.Catcher not venting air.	3.Clean grass catcher.
Hard to push	1.Grass is too high or wheel height is too low.	1.Raise cutting height
	2.Rear of lawn mower housing/blade dragging in grass.	2.Raise rear of lawn mower housing one (1) setting higher.
	3.Grass catcher too full.	3.Empty grass catcher.
	4.Handle height position not right for you.	4.Adjust handle height to suit.
Loss of drive (Power propelled)	1. Belt wear.	1.Check/replace drive belt.
	2.Belt off of pulley.	2.Check/reinstall drive belt.
	3.Dirt in drive pinions.	3.Clean drive pinions.
Loss of power	1.Rear of lawn mower housing of cutting blade dragging in heavy grass.	1.Set to "Higher Cut" position.
	2.Cutting too much grass.	2.Set to "Higher Cut" position.
	3.Dirty air filter.	3.Clean/replace air filter.
	4.Buildup of grass, leaves, and trash under mower.	4.Clean underside of mower housing.
	5.Too much oil in engine.	5.Check oil level.
	6.Walking speed too fast.	6.Cut at slower walking speed.
Poor cut-uneven	1.Worn, bent or loose blade.	1.Replace blade. Tighten blade bolt.
	2.Wheel heights uneven.	2.Set all wheels at same height.
	3.Buildup of grass, leaves and trash under mower.	3.Clean underside of mower housing.
Excessive vibration	1.Worn, bent or loose blade.	1.Replace blade. Tighten blade bolt.
	2.Bent engine crankshaft.	2.Contact a qualified service center.

※ 1)Ensure the engine and blades are stopped and the spark plug disconnected before performing any maintenance, do not touch the engine muffler after use at very high temperature.

ATTENTION: Before the mower is stored, make sure the engine cool.

TRANSPORTATION:

Turn off the engine. Make sure the blade are not bent or damaged when you are pushing the mower over obstacles.

WARRANTY

Proper maintenance of your Weibang equipment is the owner's responsibility. Follow the instructions in your owners guide for correct lubricants and maintenance schedule. Your Weibang dealer carries a complete line of quality lubricants and filters for your equipments engine, transmission, chassis and attachments.

We provide a 2 year warranty from date of purchase: During that time we will replace we assure a free of charge replacement of any part or parts found to be defective in material or workmanship or both, after examination by an authorized dealer, or by the service department of Weibang. We will supply repair services for the machine during a warranty period limited to 2 years.

A warranty period of 90 days applies to machines used for commercial purposes.

If your lawnmower has malfunctioned within the warranty period, and on presentation of a properly filled in warranty certificate and the purchase invoice, please contact with Your local dealer or Yangzhou Weibang Garden Machine, if there is no authorised maintenance station or dealer in your area. The machine will be repaired expense depended on warranty certificate and invoice.

All normal wear and tear and/or consumable parts are protected from manufacturer's defects in material and workmanship for a period of thirty (30) days from the date of purchase.

Damages caused by an inappropriate or faulty operation, by non-observance of the safety regulations and operating instructions contained in this manual, by unauthorised repairs or a dismantling of the machine by unauthorised persons, or any other deficiency that cannot be attributed to faulty workmanship or materials, do not fall under this guarantee. Such deficiencies, malfunctions or damages are the sole responsibility of the owner, and eventually necessary repairs are at the owner's expense.

This limited warranty gives you specific legal rights, and which is in addition to any statutory rights to which you may be entitled and your statutory rights are not affected by this warranty. If you need additional information concerning this written warranty, or assistance in obtaining services, please contact:

Yangzhou Weibang Garden Machine Company Limited
Hanjiang Industrial Park
Yangzhou, Jiangsu, P.R. CHINA

Tel: +86-514-87849959, +86-514-87849975 Fax: +86-514-87849938

Email questions and comments to:

Sale@weibang.com

Visit our website:

www.weibang.com